

DESIGN AND CREATED BY KAIEI3D 2023

2023 年由KAIEI3D 设计与建模

PLEASE RESPECT TO THE DESIGNER EFFORT DO NOT STEAL DESIGN

请尊重设计师，切勿偷盗别人的设计

WARNING : Pirate pictures must be investigated 盗图必究

06 3D PRINT 1:20
MS06 ZAKU-II

KAIEI3D
TOYS - GADGET - HOBBY

1/20 3D Print Zaku II PART 1 : HEAD

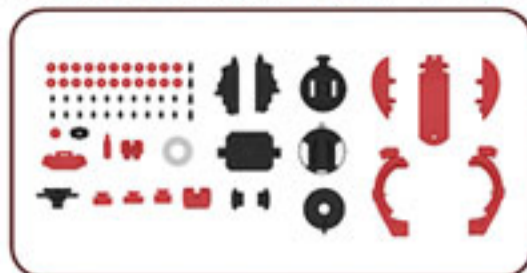

70 parts / 530g PLA / 32hours

1/20 3D Print Zaku II PART 2 : BODY

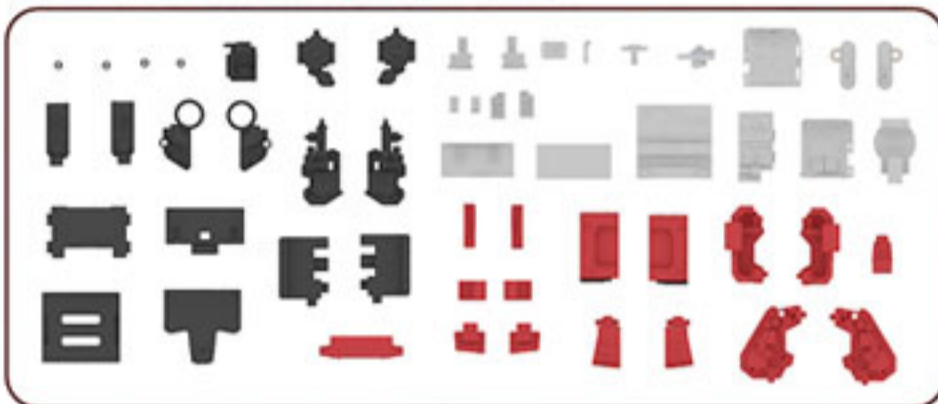

54 parts / 1850g PLA / 180hours

1/20 3D Print Zaku II PART 3 : BACKPACK

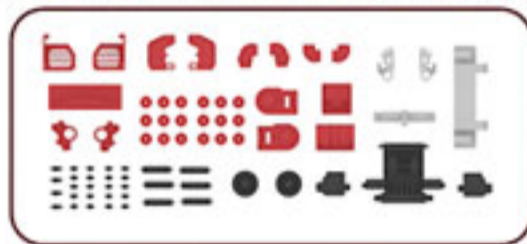

72 parts / 530g PLA / 25hours

1/20 3D Print Zaku II PART - : EXTRA

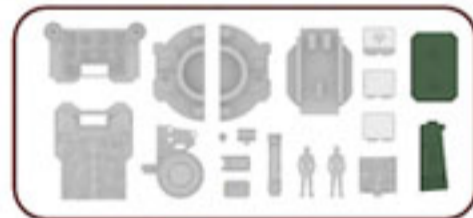

19 parts / 690g PLA / 30hours

1/20 3D Print Zaku II PART FINALE : ARMS

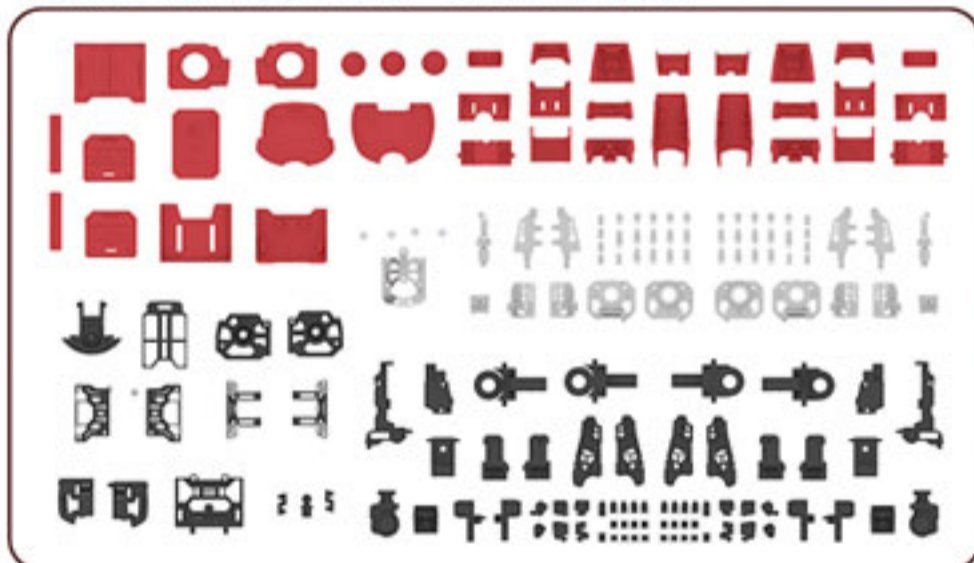

180 parts / 2700g PLA / 155hours

1/20 3D Print Zaku II PART 4 : WAIST

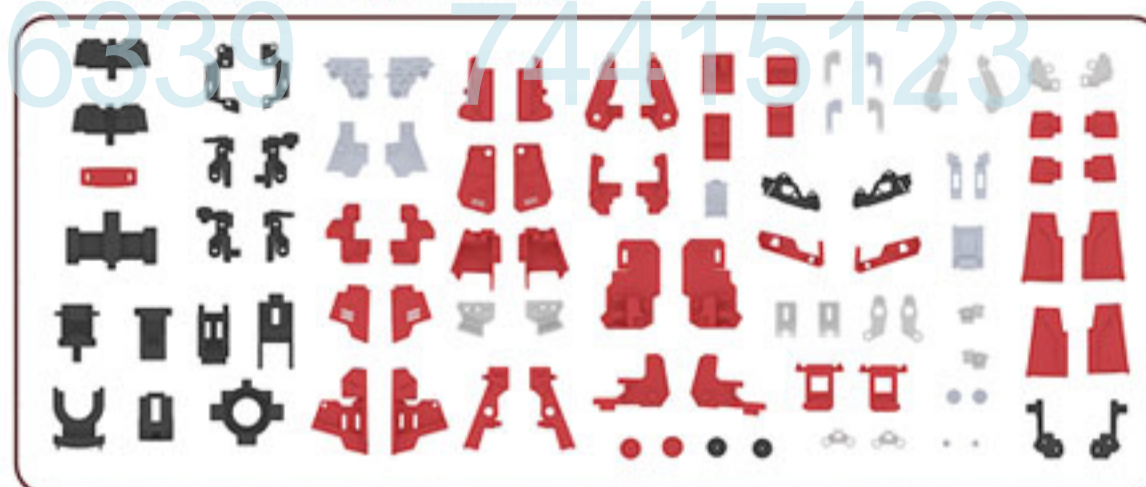

94 parts / 3000g PLA / 100hours

1/20 3D Print Zaku II PART 5 : LEGS

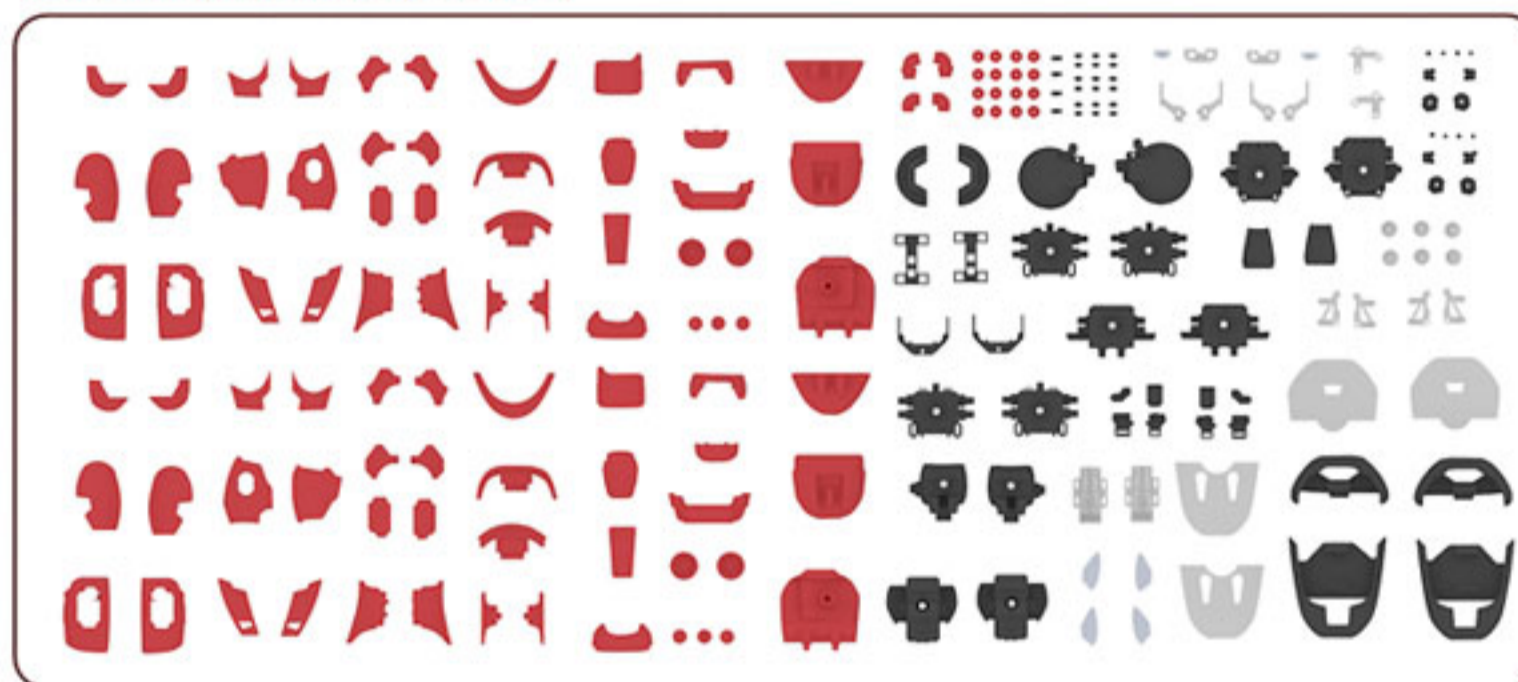

203 parts / 4400g PLA / 335hours



180cm Male
101cm
3D PRINT 1/20 ZAKU II
692 parts / 13.7kg / 857 hours

DESIGN AND CREATED BY KAIEI3D 2023

2023 年由KAIEI3D 设计与建模

PLEASE RESPECT TO THE DESIGNER EFFORT DO NOT STEAL DESIGN

请尊重设计师，切勿偷盗别人的设计

WARNING : Pirate pictures must be investigated 盗图必究



TOYS - GADGET - HOBBY



3D PRINT 1:20

NOTICE



3D printer with
build volume
180mm x 180mm
x180mm above



Cutter & filler
or sanding
tools



Super Glue*part thats
not involve to artlication
are advise to glue it if
too loose



Estimate ready
14KG above
filament



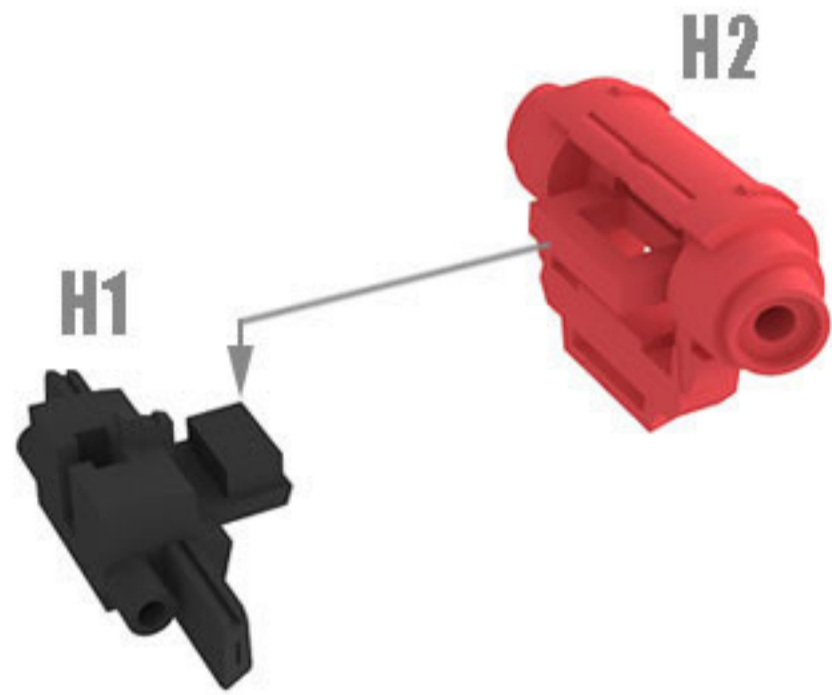

Z1

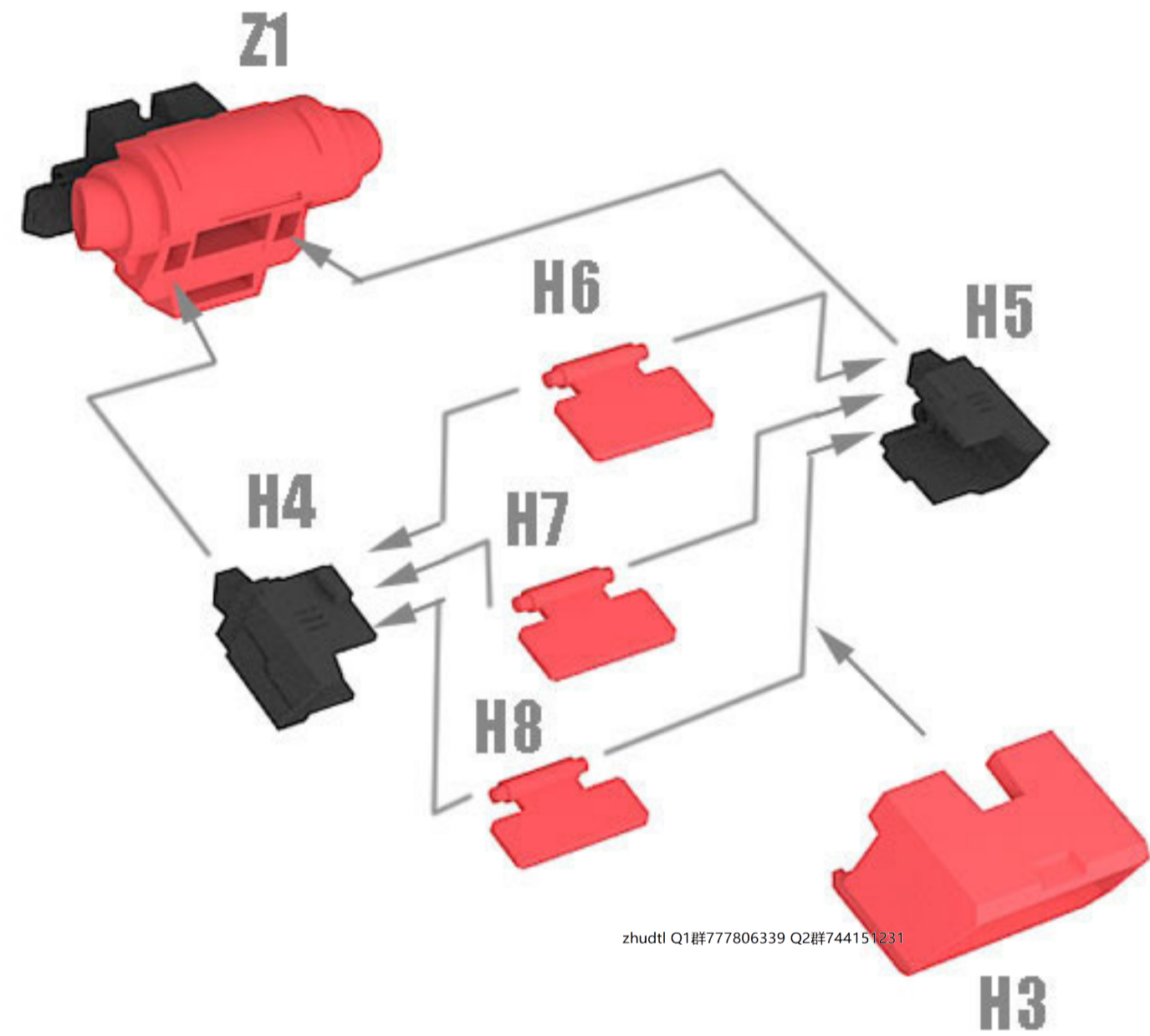

zhudtl Q群777806339 744151231

Z2



Z3

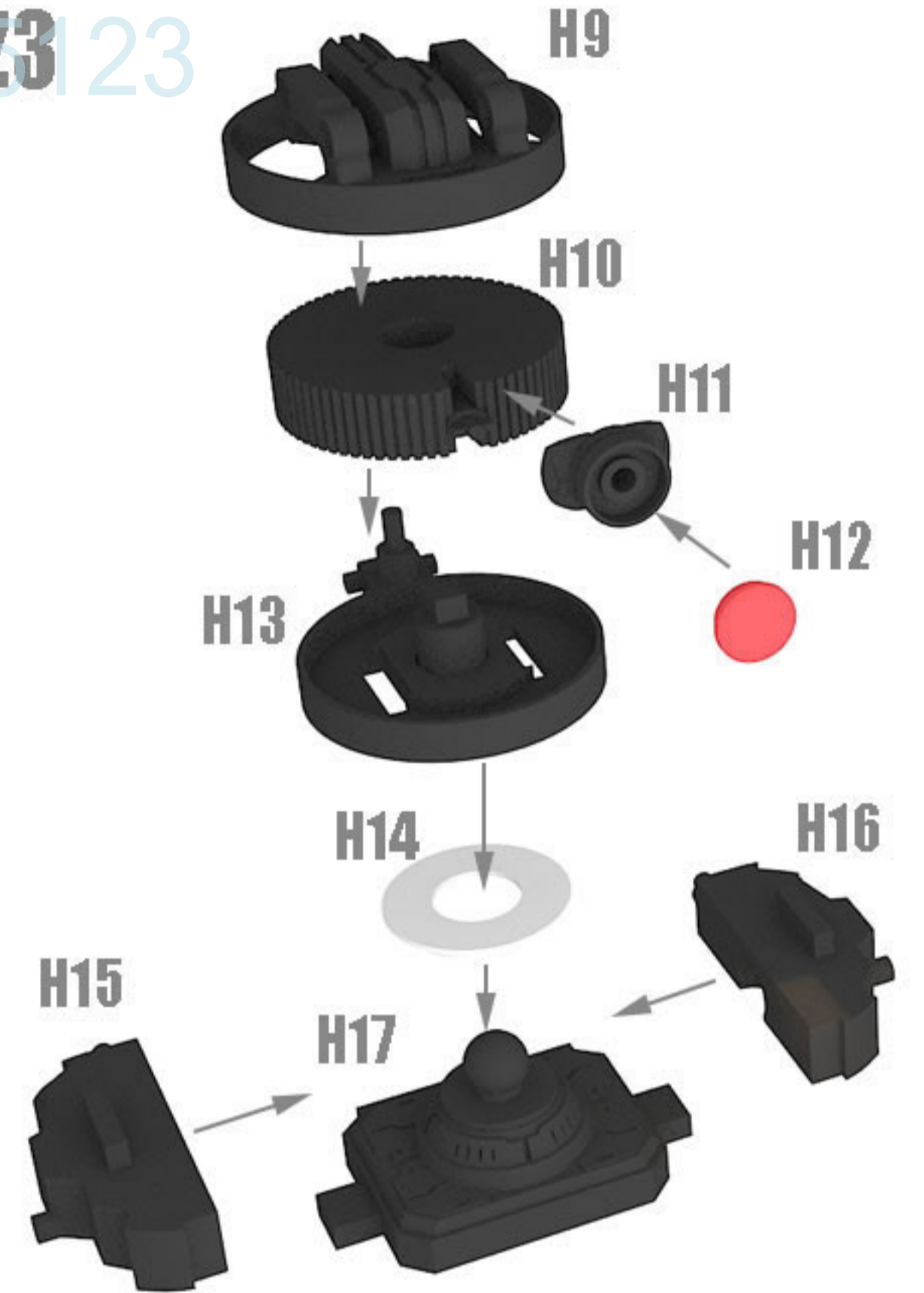

DESIGN AND CREATED BY KAIEI3D 2023
 2023 年由KAIEI3D 设计与建模
 PLEASE RESPECT TO THE DESIGNER EFFORT DO NOT STEAL DESIGN
 请尊重设计师，切勿偷盗别人的设计
 WARNING : Pirate pictures must be investigated 盗图必究



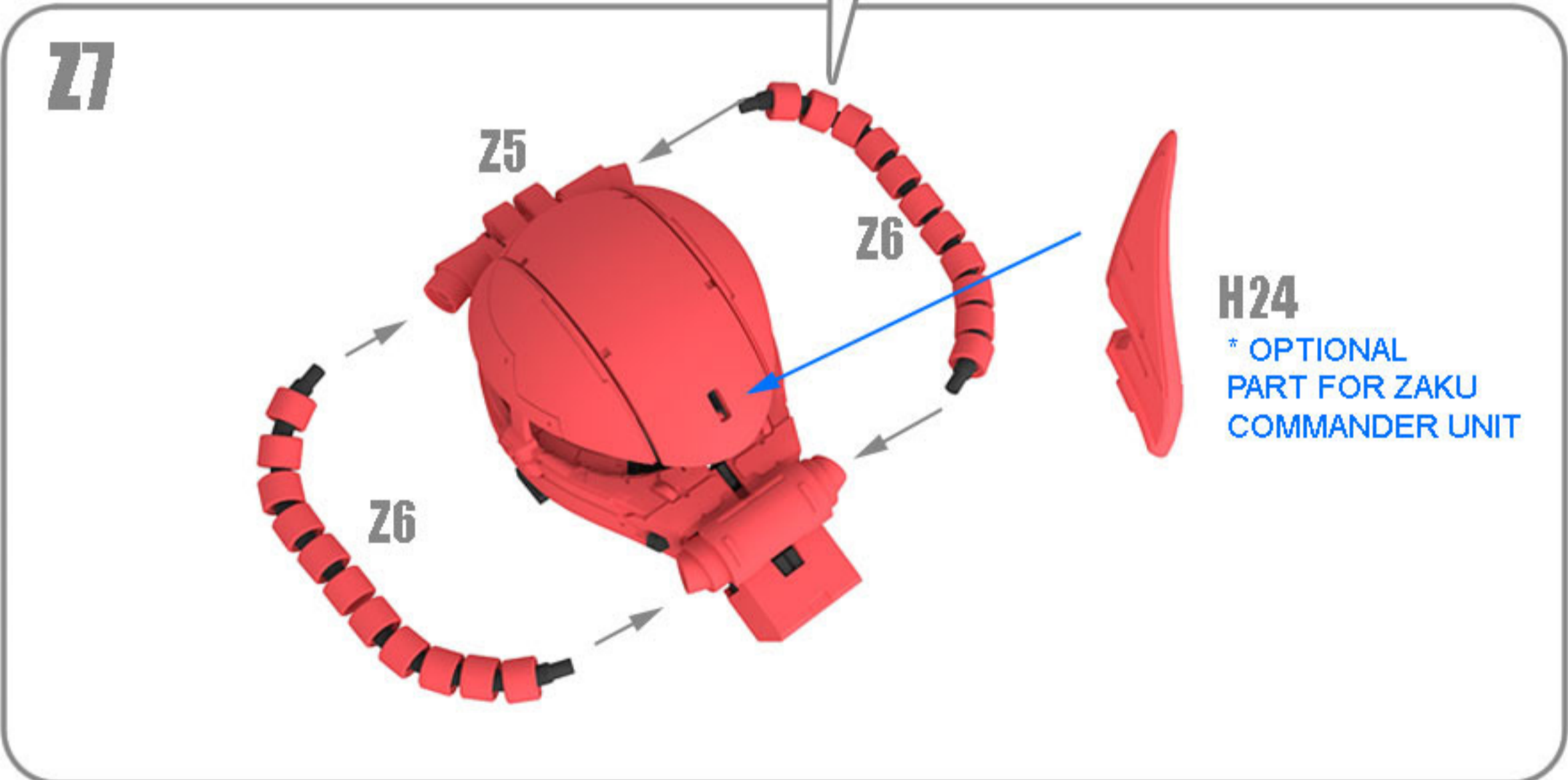
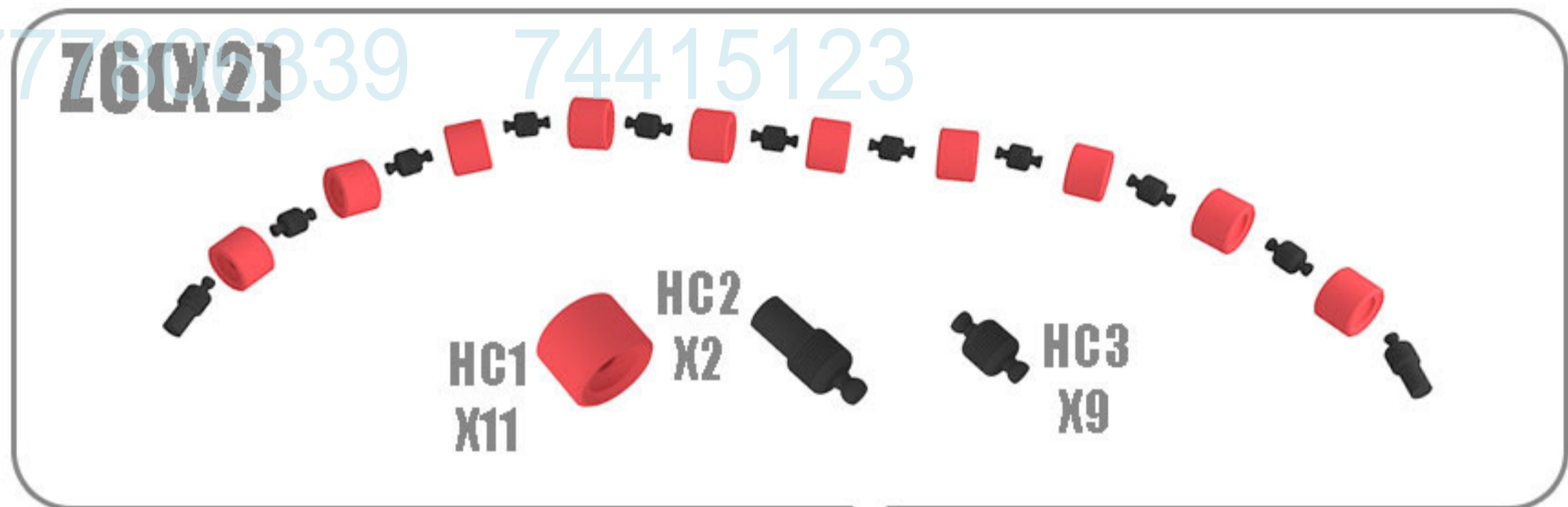
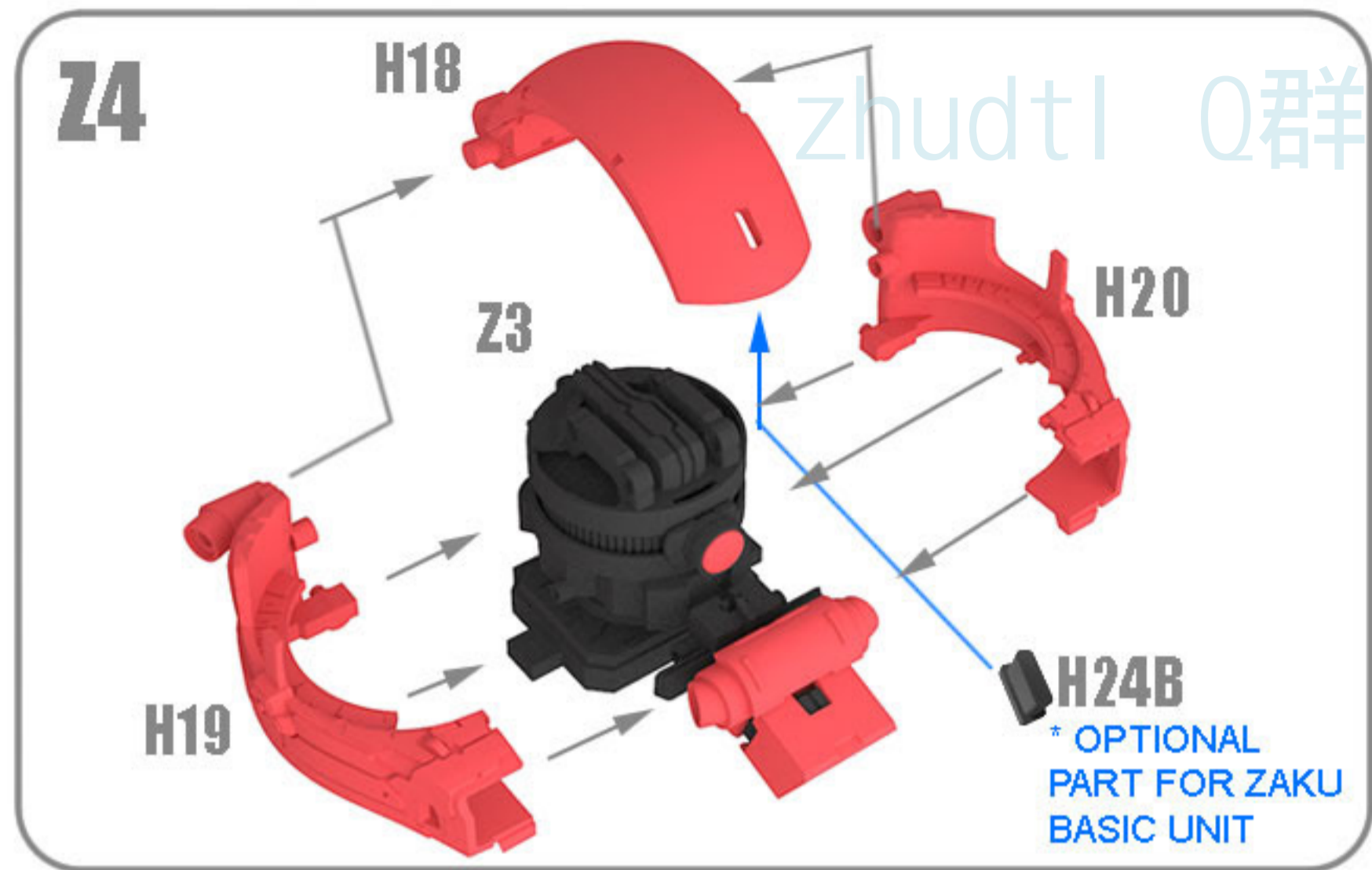

DESIGN AND CREATED BY KAIEI3D 2023
 2023 年由KAIEI3D 设计与建模
 PLEASE RESPECT TO THE DESIGNER EFFORT DO NOT STEAL DESIGN
 请尊重设计师，切勿偷盗别人的设计
 WARNING : Pirate pictures must be investigated 盗图必究

06 3D PRINT 1:20
MS06 ZAKU-II HEAD

Z8

zhudtl Q群777806339 74415123

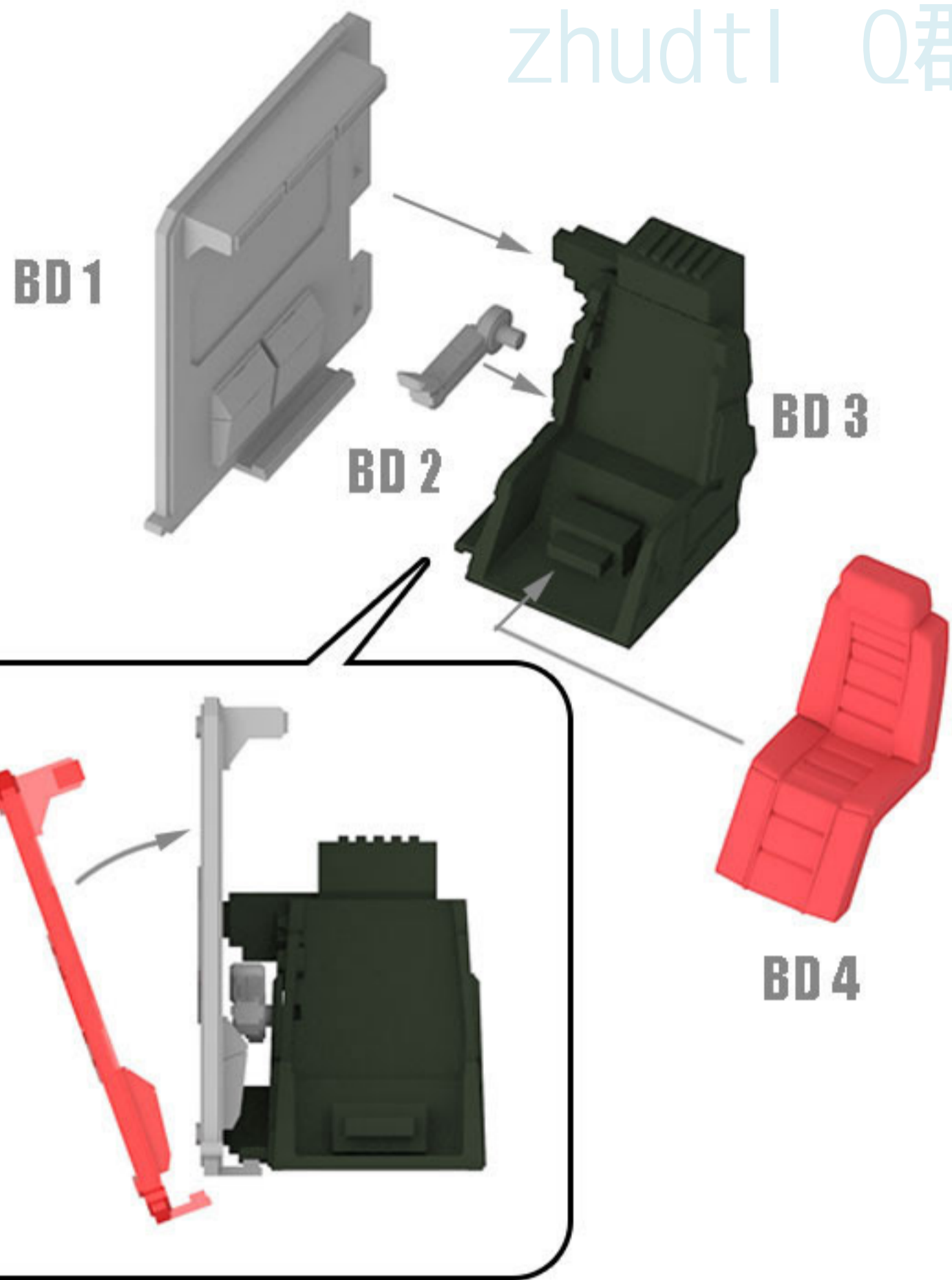

Z9

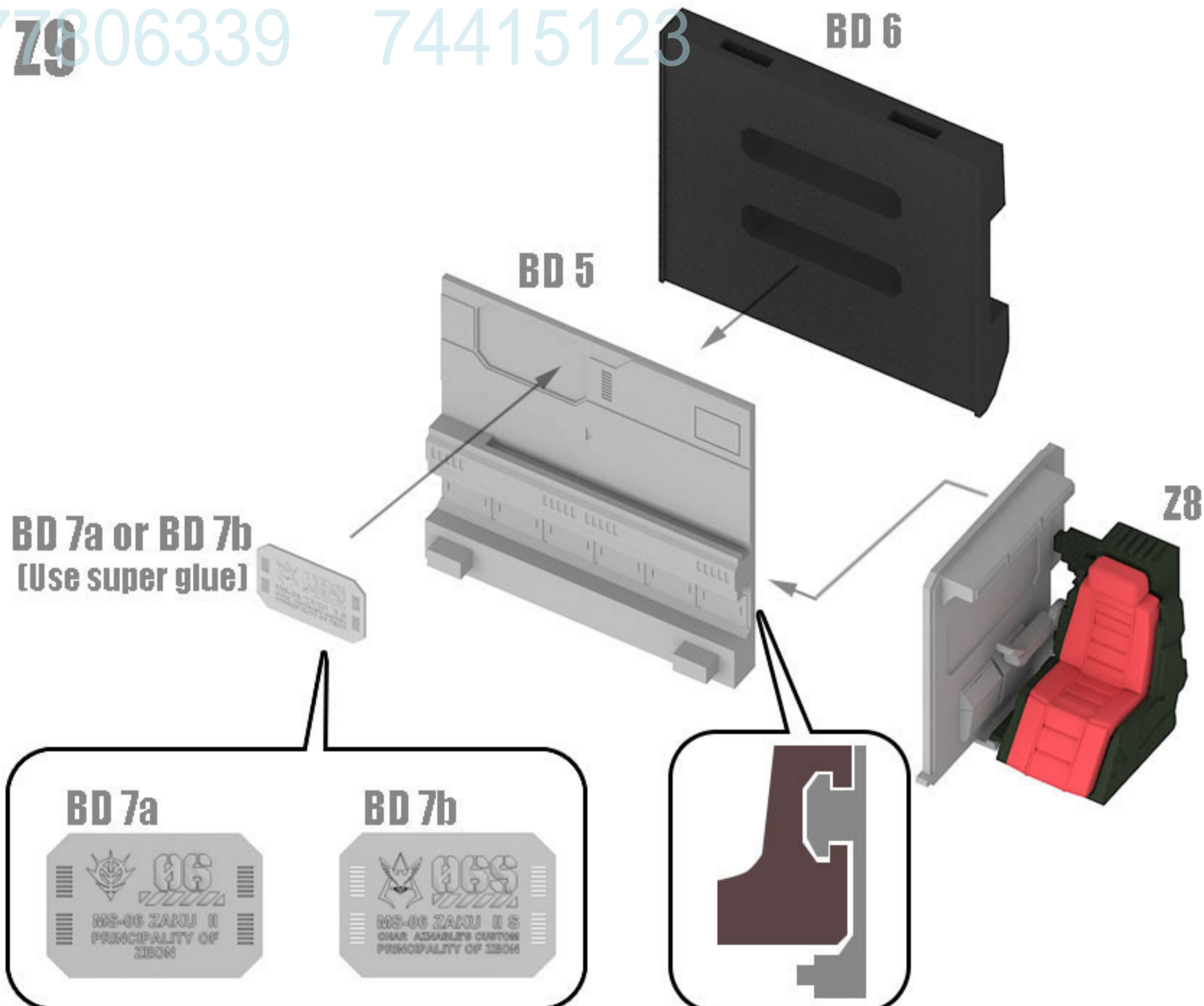

DESIGN AND CREATED BY KAIEI3D 2023

2023 年由KAIEI3D 设计与建模

PLEASE RESPECT TO THE DESIGNER EFFORT DO NOT STEAL DESIGN

请尊重设计师，切勿偷盗别人的设计

WARNING : Pirate pictures must be investigated 盗图必究



3D PRINT 1:20

zhudtl Q群777806339 74415123

Z10

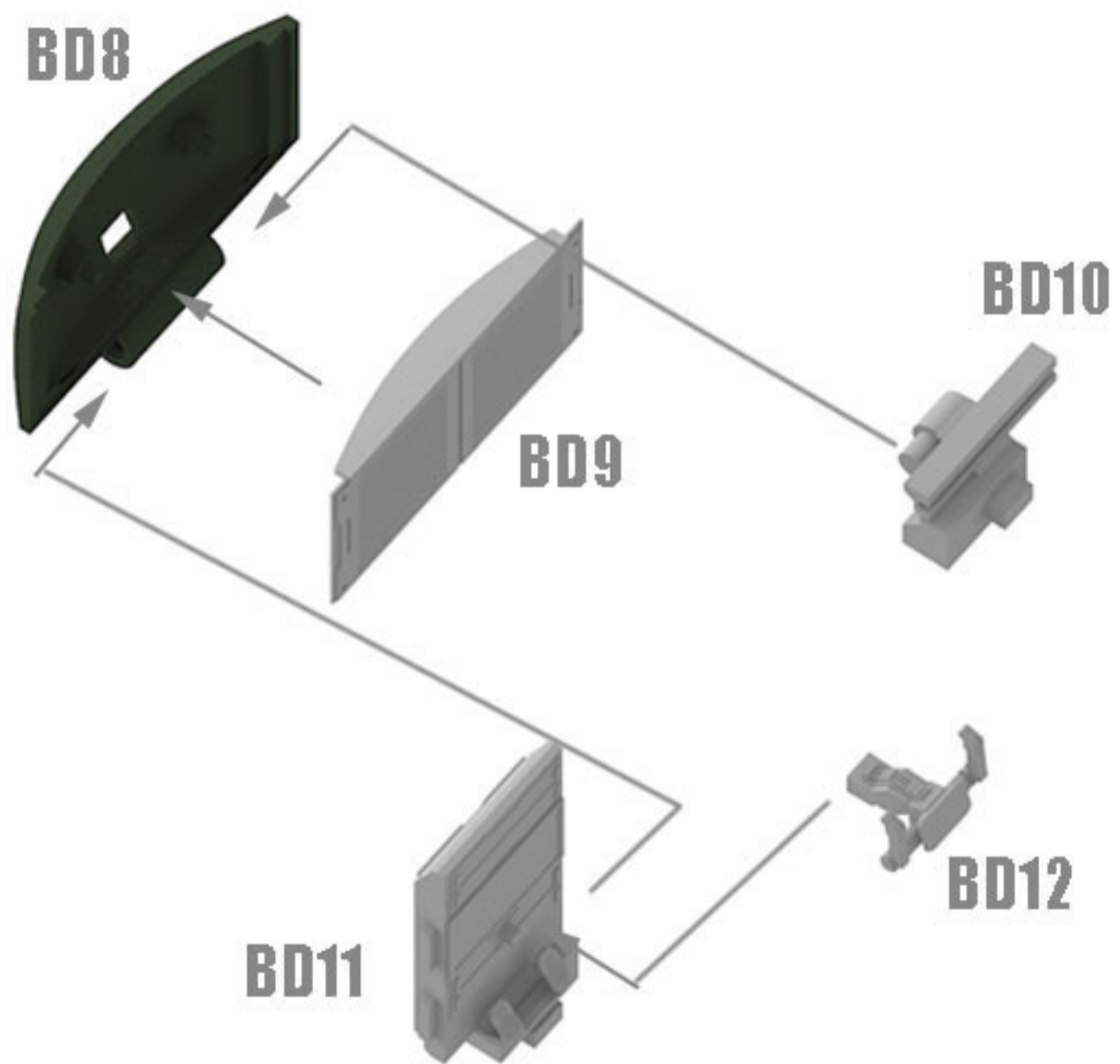

Z11

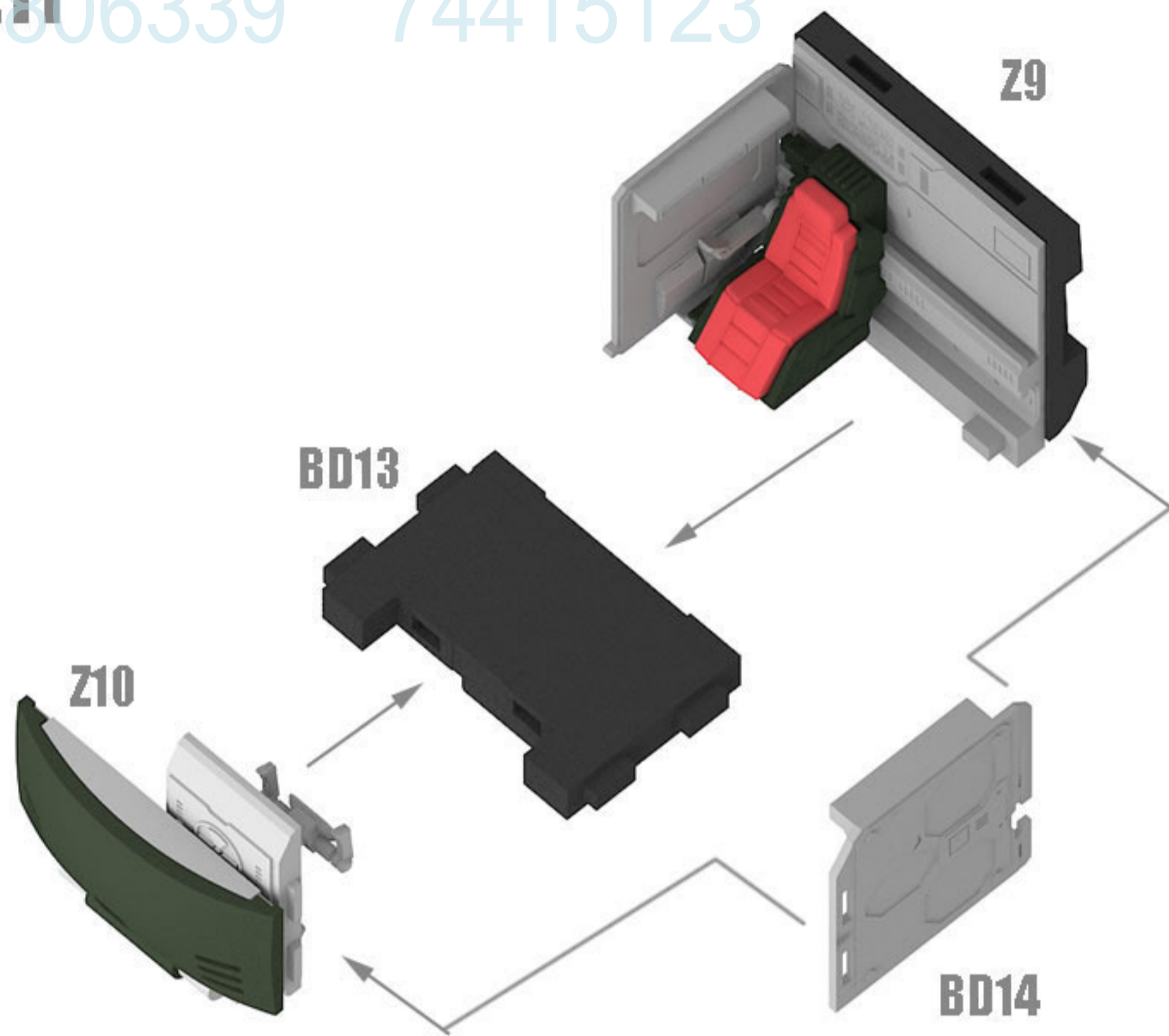

DESIGN AND CREATED BY KAIEI3D 2023

2023 年由KAIEI3D 设计与建模

PLEASE RESPECT TO THE DESIGNER EFFORT DO NOT STEAL DESIGN

请尊重设计师，切勿偷盗别人的设计

WARNING : Pirate pictures must be investigated 盗图必究

KAIEI3D
TOYS · GADGET · HOBBY

06 3D PRINT 1:20
MS06 ZAKU-II

Z12

zhudt | Q群777806339 Z13 74415123

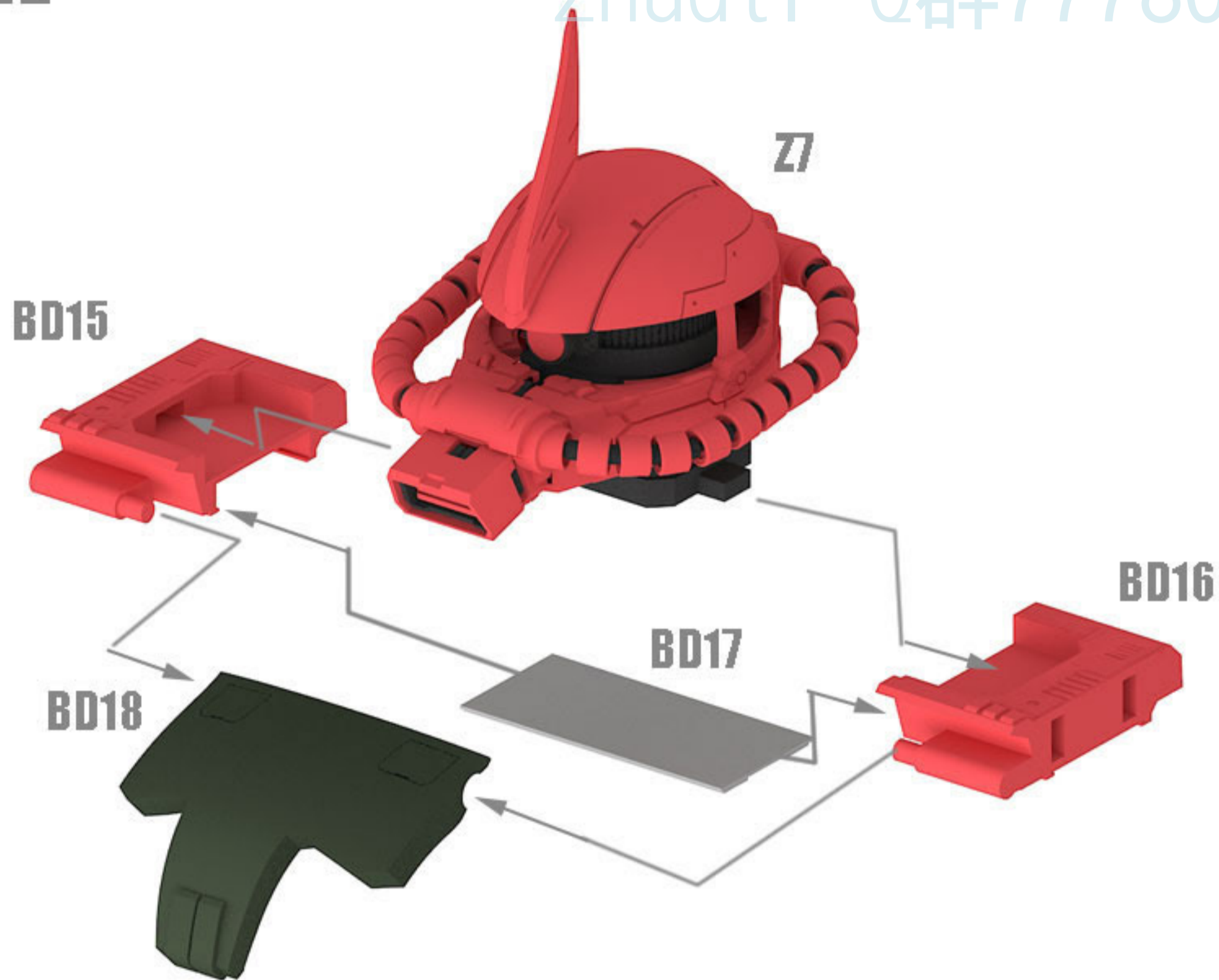

Z13



DESIGN AND CREATED BY KAIEI3D 2023

2023 年由KAIEI3D 设计与建模

PLEASE RESPECT TO THE DESIGNER EFFORT DO NOT STEAL DESIGN

请尊重设计师，切勿偷盗别人的设计

WARNING : Pirate pictures must be investigated 盗图必究



714

zhudt | Q群777806339 74415123

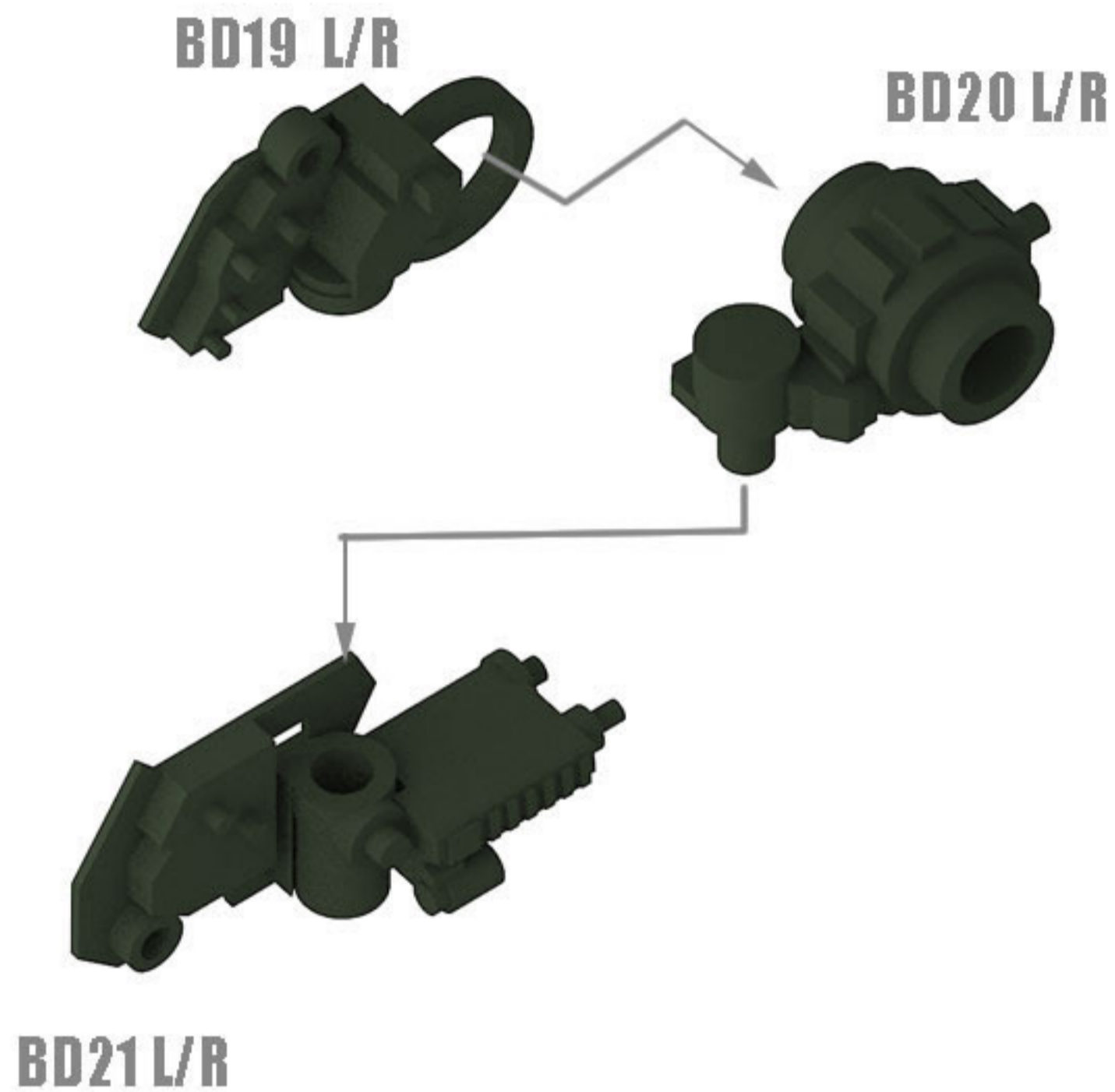

715

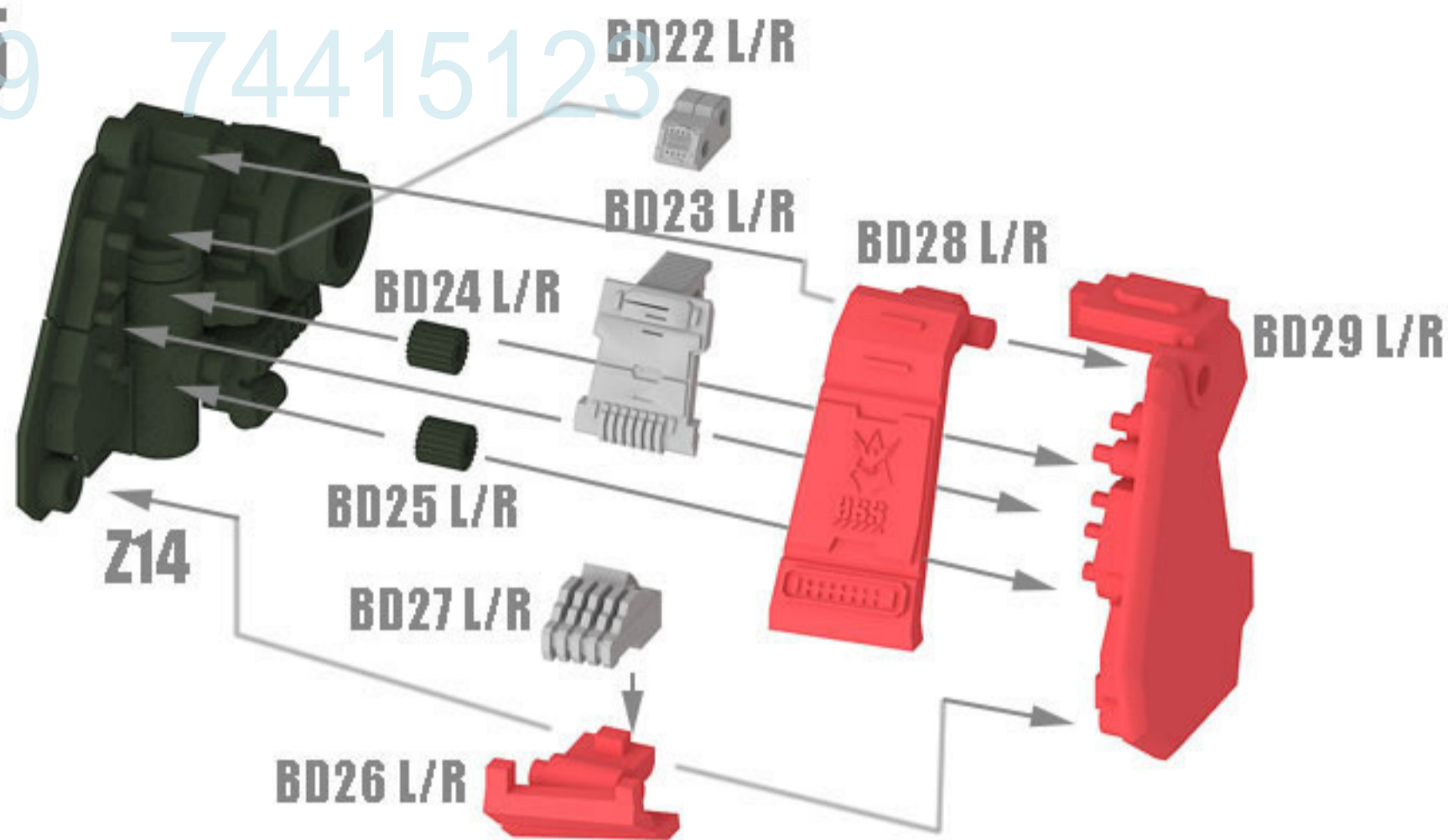

BD28R A



BD28R B

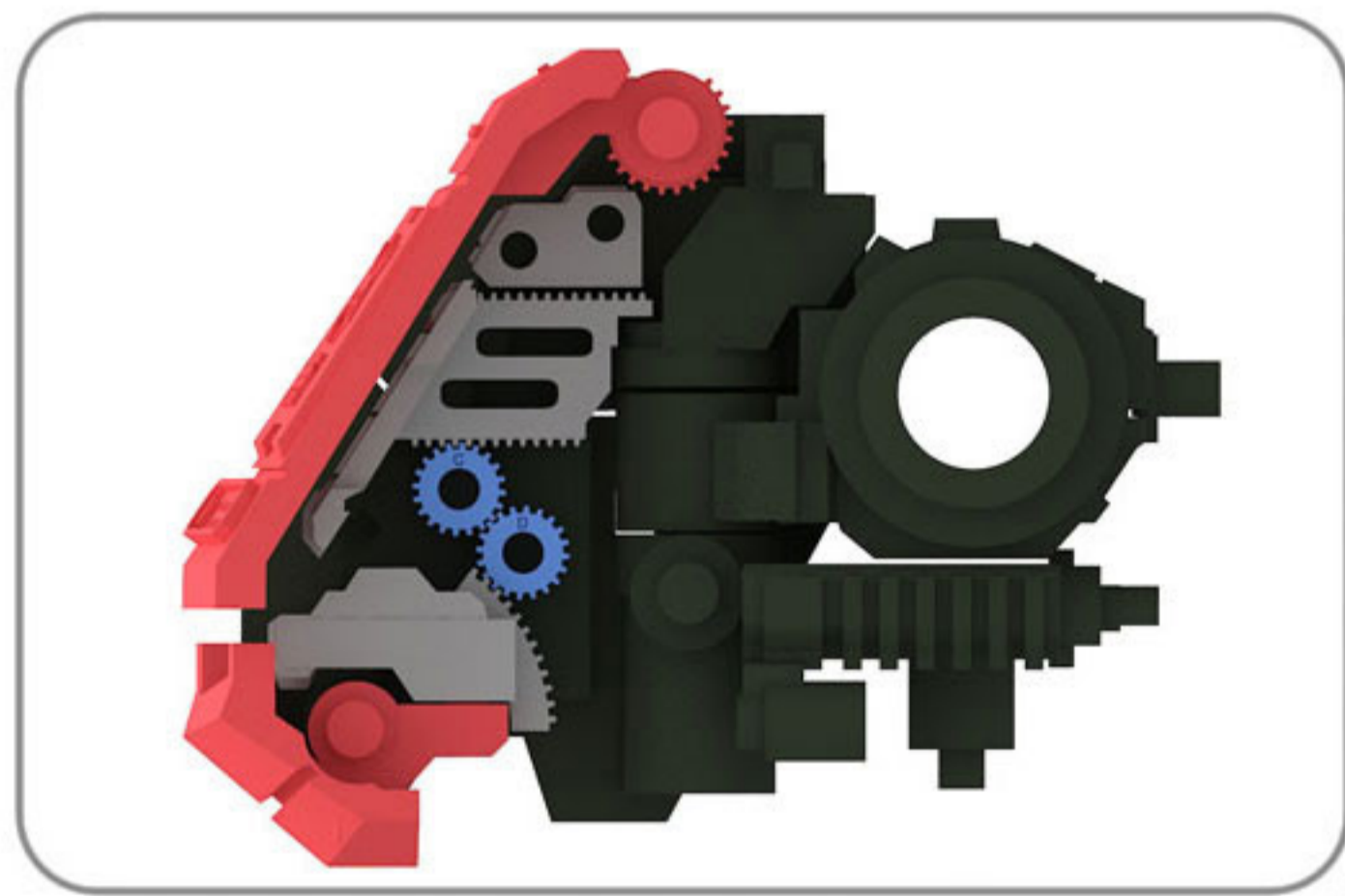

DESIGN AND CREATED BY KAIEI3D 2023

2023 年由KAIEI3D 设计与建模

PLEASE RESPECT TO THE DESIGNER EFFORT DO NOT STEAL DESIGN

请尊重设计师，切勿偷盗别人的设计

WARNING : Pirate pictures must be investigated 盗图必究



TOYS - GADGET - HOBBY



3D PRINT 1:20

zhudt | Q群777806339 74415123

Z16

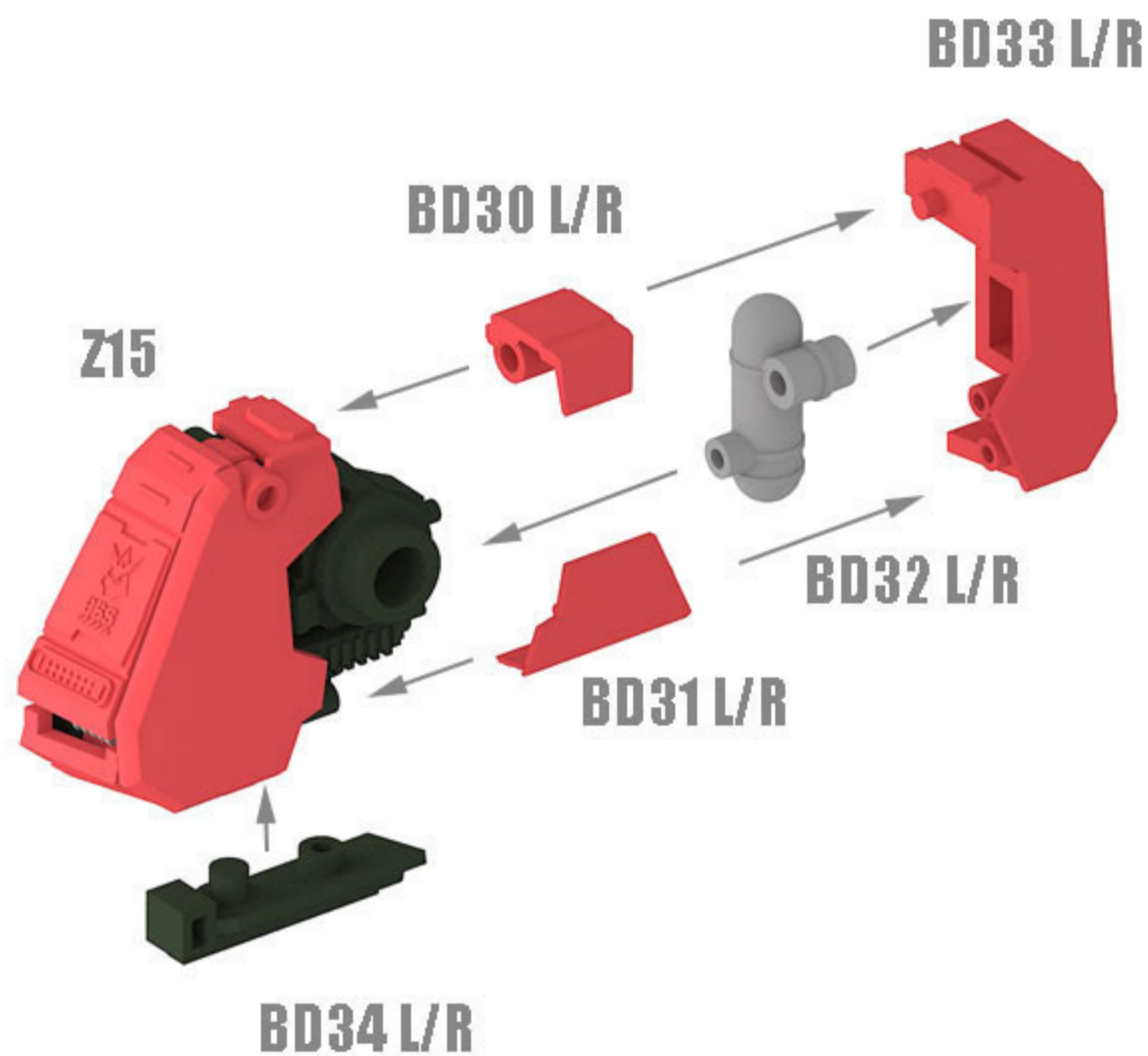

Z17

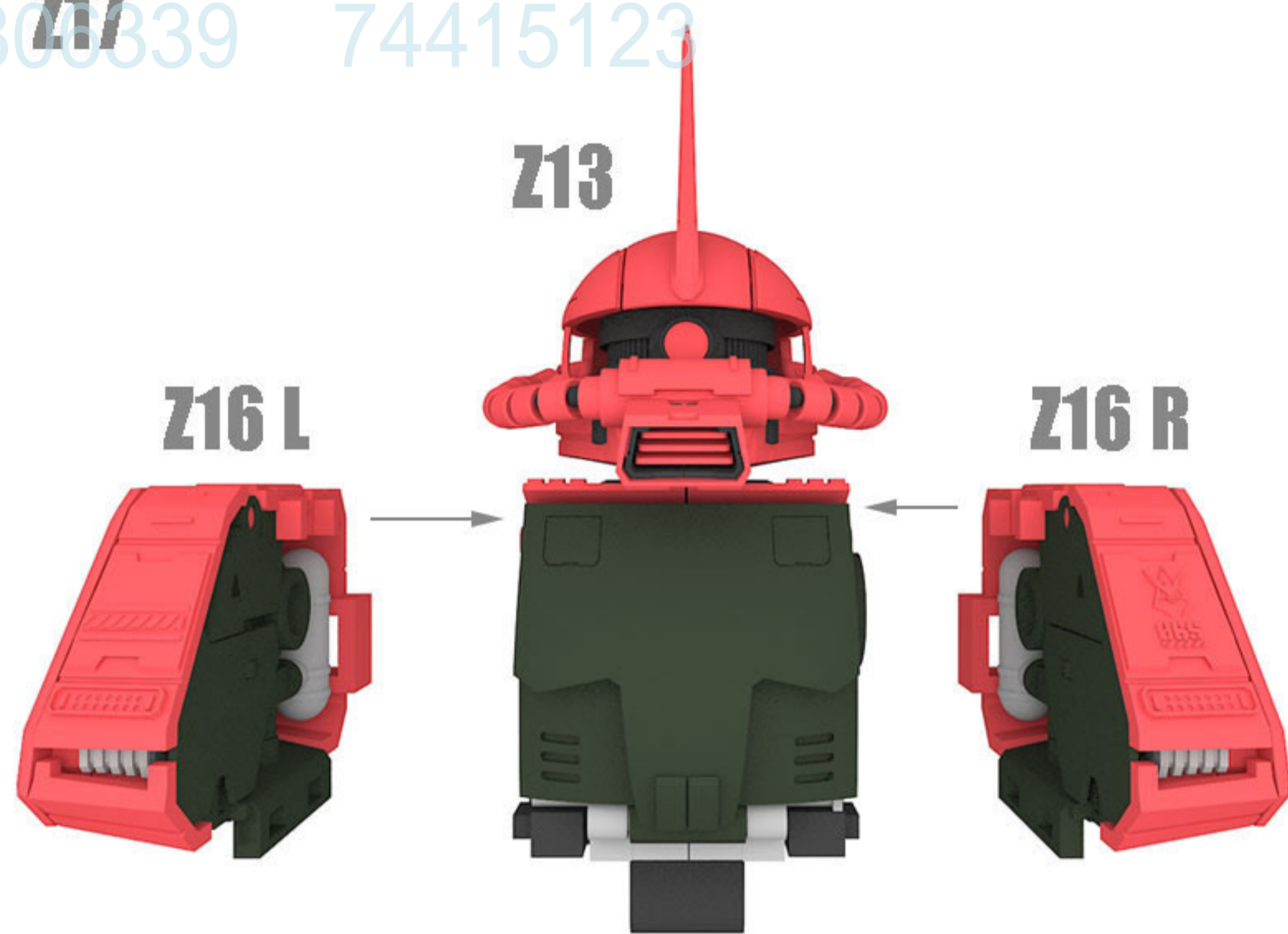

DESIGN AND CREATED BY KAIEI3D 2023

2023 年由KAIEI3D 设计与建模

PLEASE RESPECT TO THE DESIGNER EFFORT DO NOT STEAL DESIGN

请尊重设计师，切勿偷盗别人的设计

WARNING : Pirate pictures must be investigated 盗图必究

KAIEI3D
TOYS · GADGET · HOBBY

06 3D PRINT 1:20
MS06 ZAKU-II

Z18

zhudtl Q群777806339 Z19 74415123

Z17

zhudtl Q1群777806339 Q2群744151231

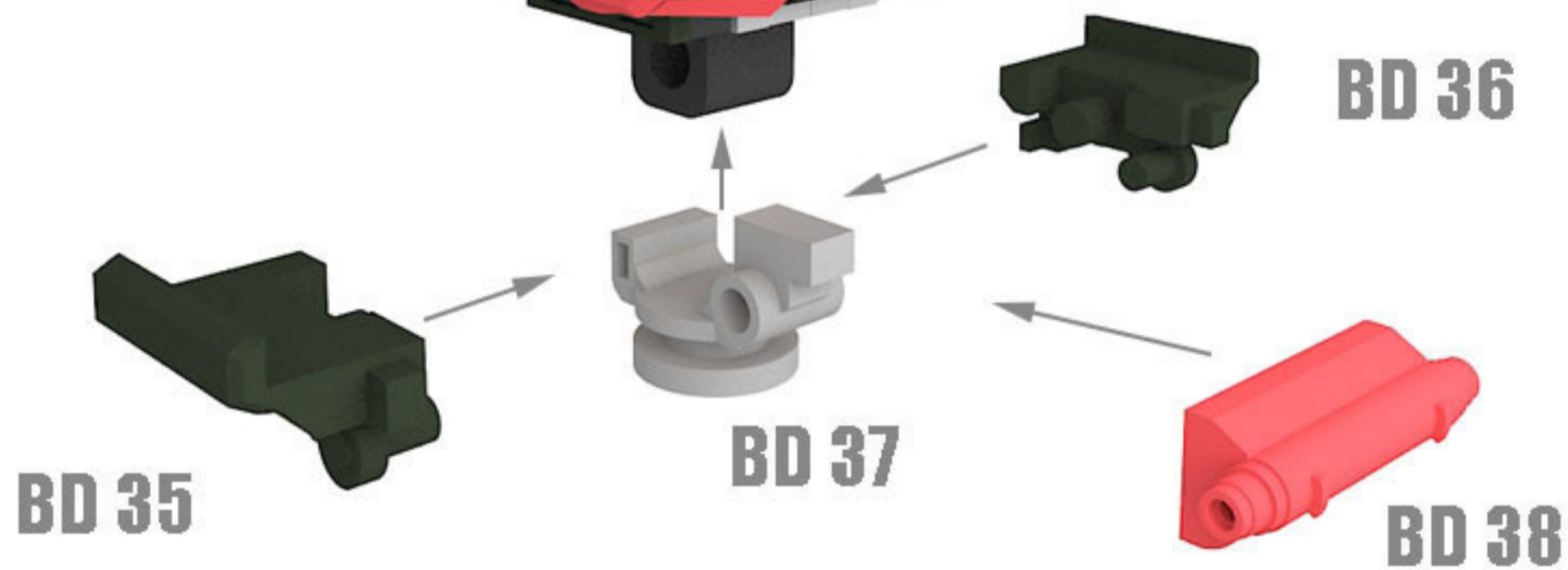

Z19

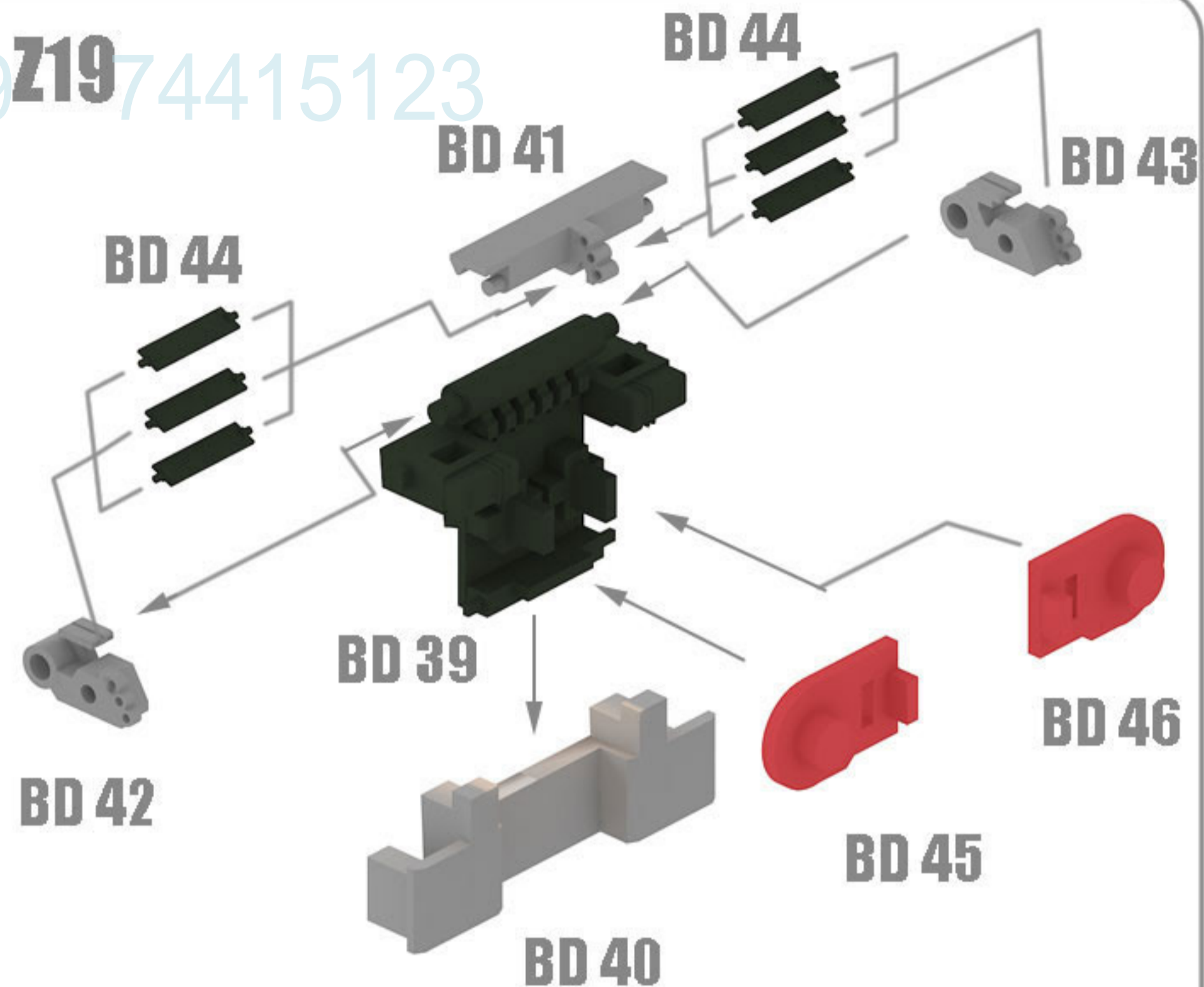

DESIGN AND CREATED BY KAIEI3D 2023

2023 年由KAIEI3D 设计与建模

PLEASE RESPECT TO THE DESIGNER EFFORT DO NOT STEAL DESIGN

请尊重设计师，切勿偷盗别人的设计

WARNING : Pirate pictures must be investigated 盗图必究



Z20

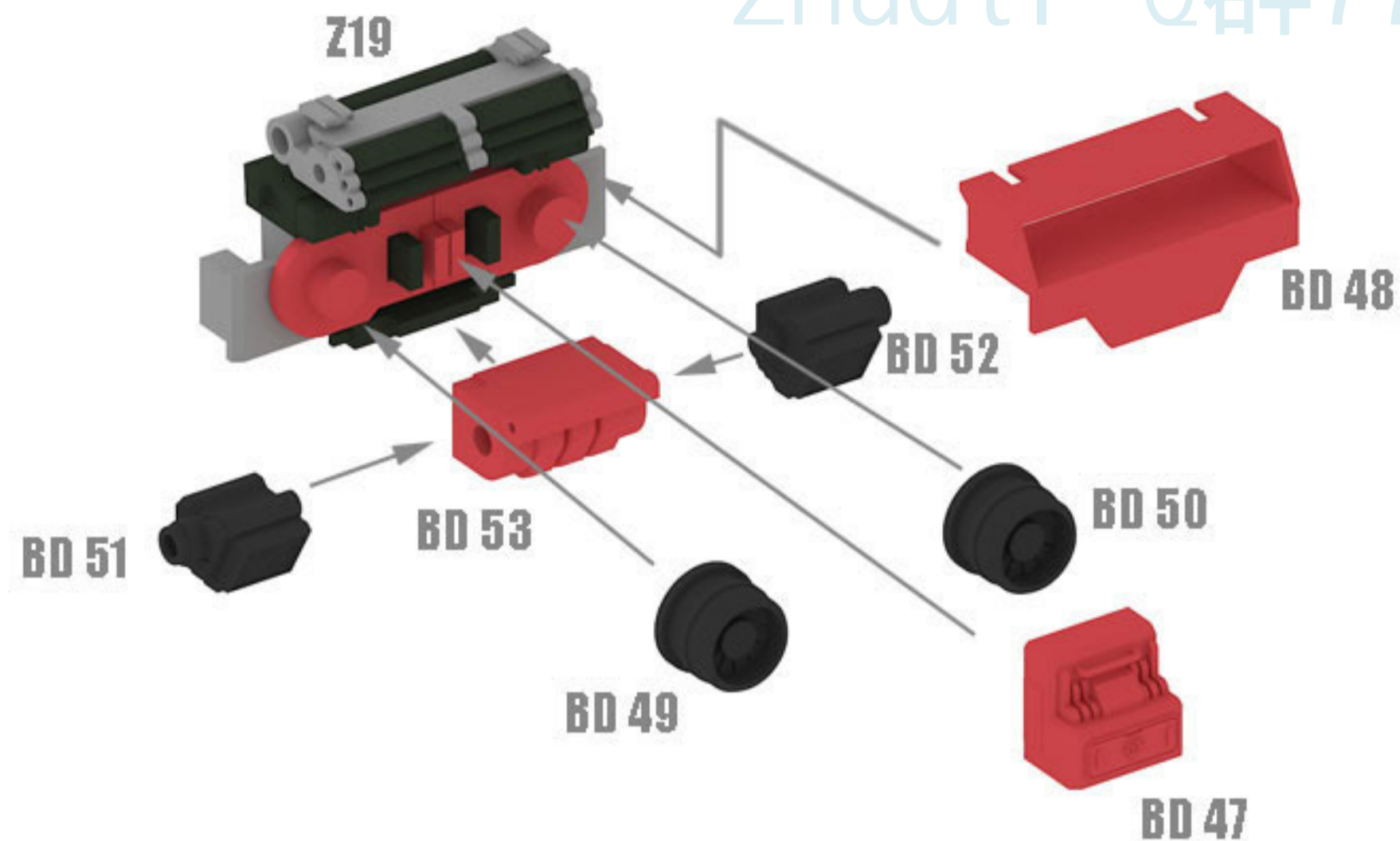

Z21

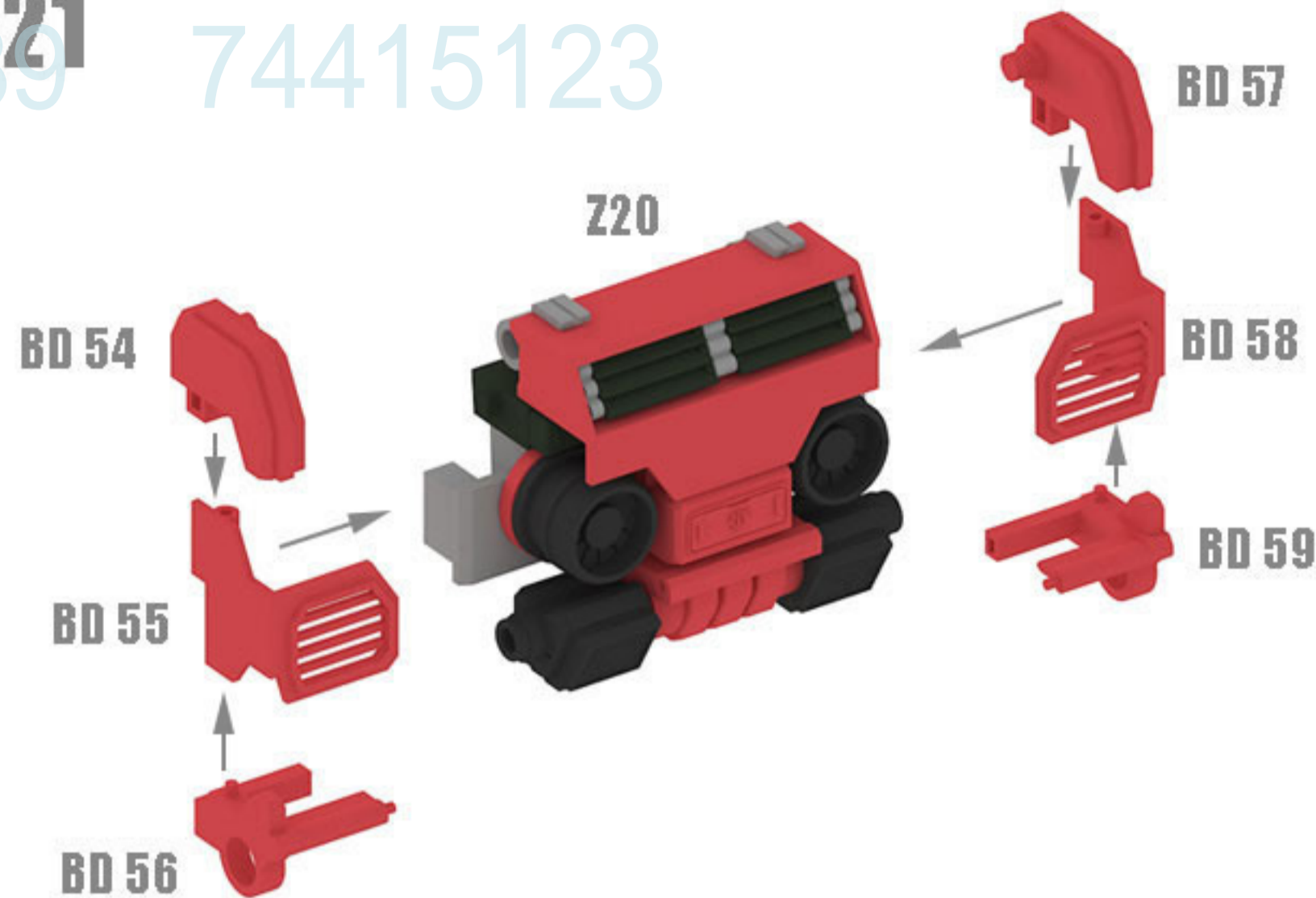

Z22(X2)

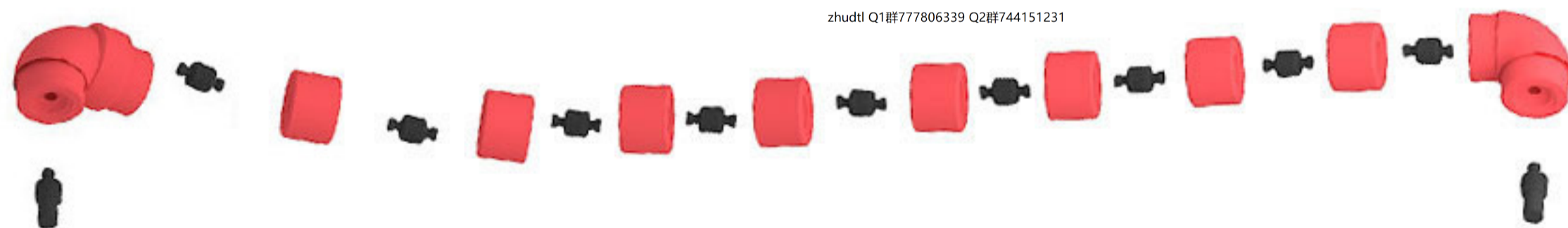

HC4 L/R



HC5 L/R



HC6 X8



HC3 X9



HC2 X2



DESIGN AND CREATED BY KAIEI3D 2023

2023 年由KAIEI3D 设计与建模

PLEASE RESPECT TO THE DESIGNER EFFORT DO NOT STEAL DESIGN

请尊重设计师，切勿偷盗别人的设计

WARNING : Pirate pictures must be investigated 盗图必究



TOYS - GADGET - HOBBY



3D PRINT 1:20

Z23

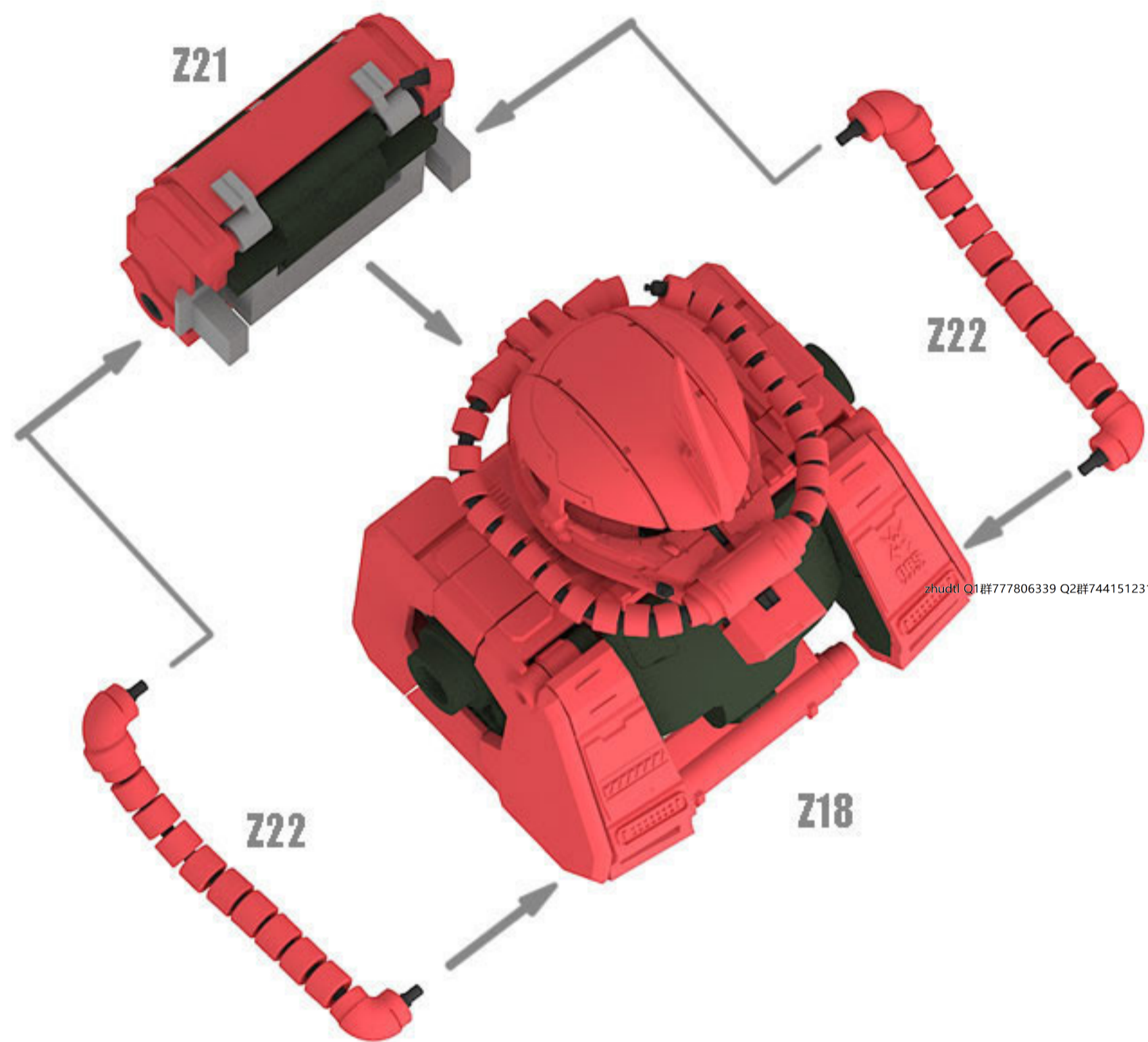

Z24

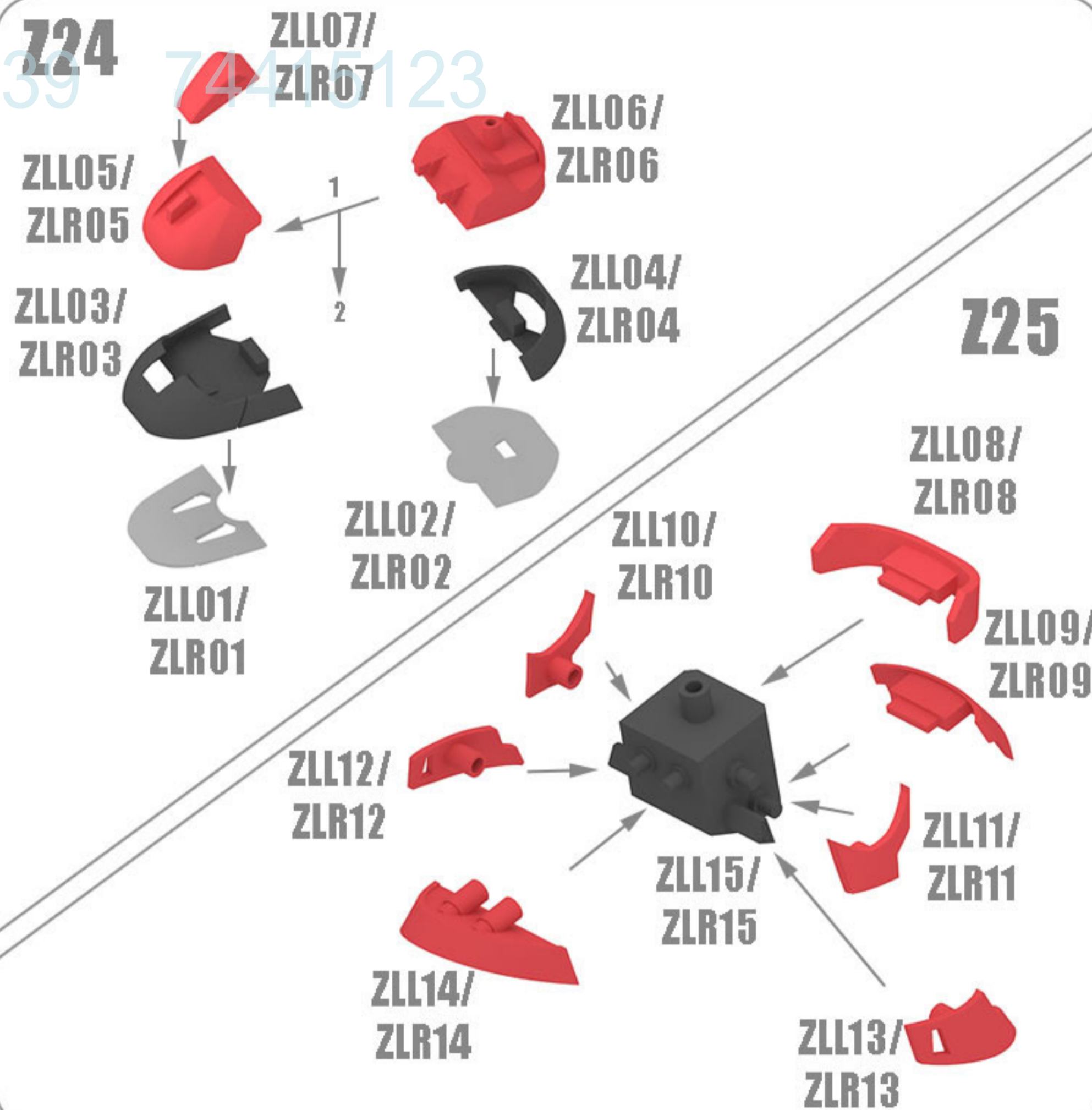

Z25

DESIGN AND CREATED BY KAIEI3D 2023

2023 年由KAIEI3D 设计与建模

PLEASE RESPECT TO THE DESIGNER EFFORT DO NOT STEAL DESIGN

请尊重设计师，切勿偷盗别人的设计

WARNING : Pirate pictures must be investigated 盗图必究

KAIEI3D

TOYS · GADGET · HOBBY

06

MS06 ZAKU-II

3D PRINT 1:20

Z26

Stainless Steel Shaft Rod
øDiameter 6mm 400mm long

* this is part need to prepare by your own, It can be found in at most of the hardware store

* can replace with same size PVC pipe or wood stick

Z24



Z25

Z27

ZLL18/ ZLR18

ZLL16/ ZLR16

ZLL20/ ZLR20

ZLL17/ ZLR17

ZLL19/ ZLR19

Z26

Z28

ZLL21/ ZLR21

ZLL22/ ZLR22

Z27

DESIGN AND CREATED BY KAIEI3D 2023

2023 年由KAIEI3D 设计与建模

PLEASE RESPECT TO THE DESIGNER EFFORT DO NOT STEAL DESIGN

请尊重设计师，切勿偷盗别人的设计

WARNING : Pirate pictures must be investigated 盗图必究

KAIEI3D

TOYS · GADGET · HOBBY

06

MS06 ZAKU-II

3D PRINT 1:20

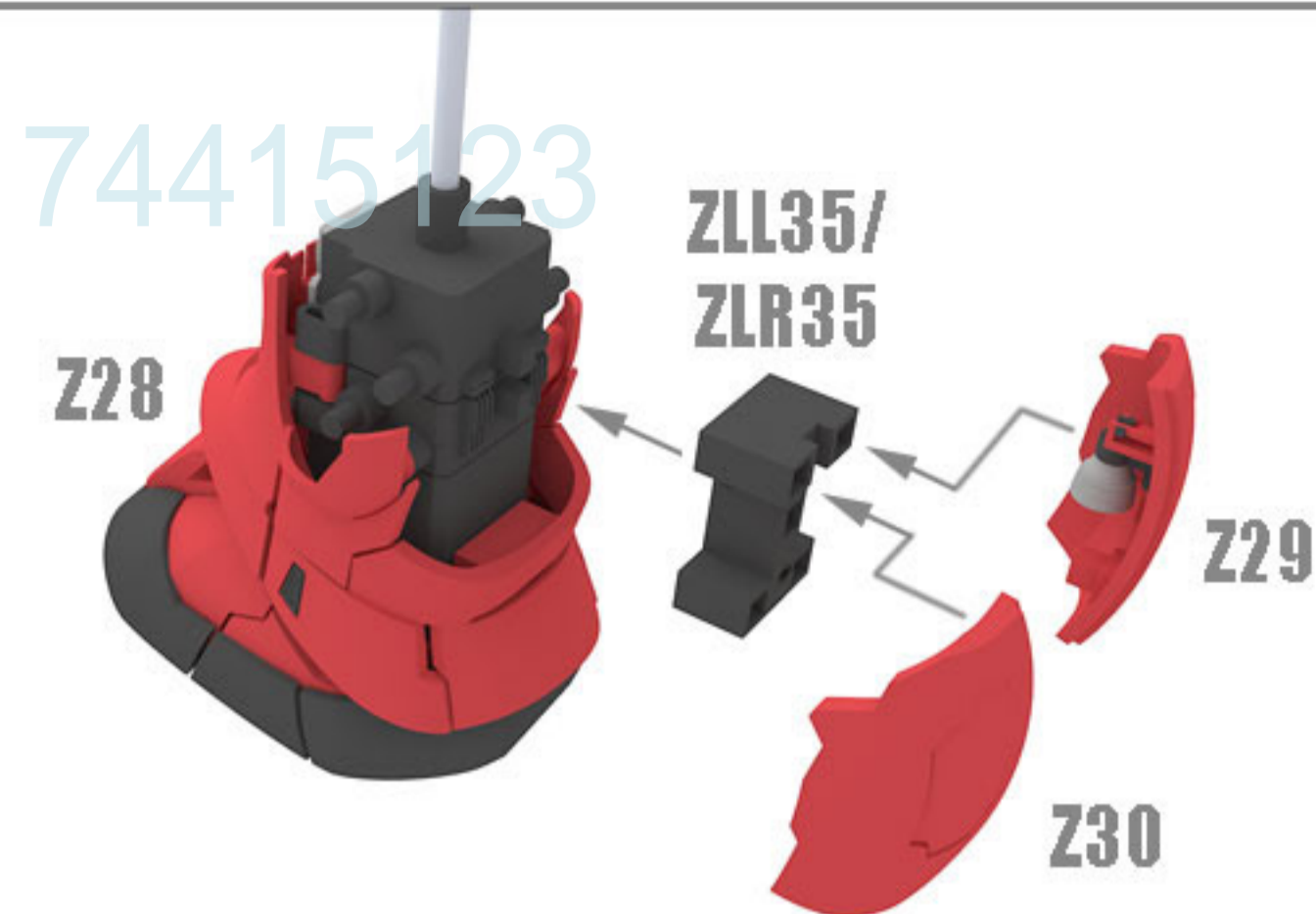
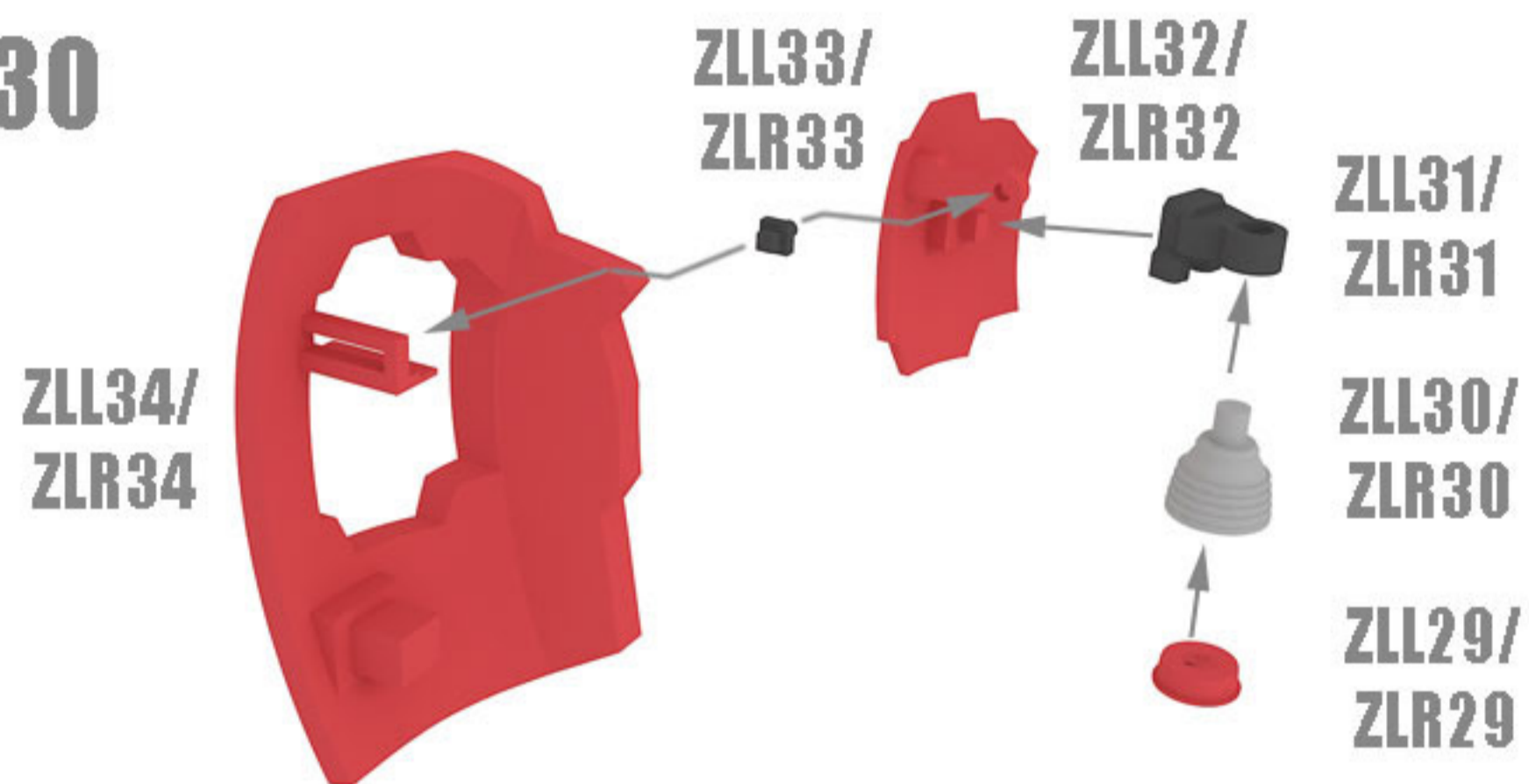
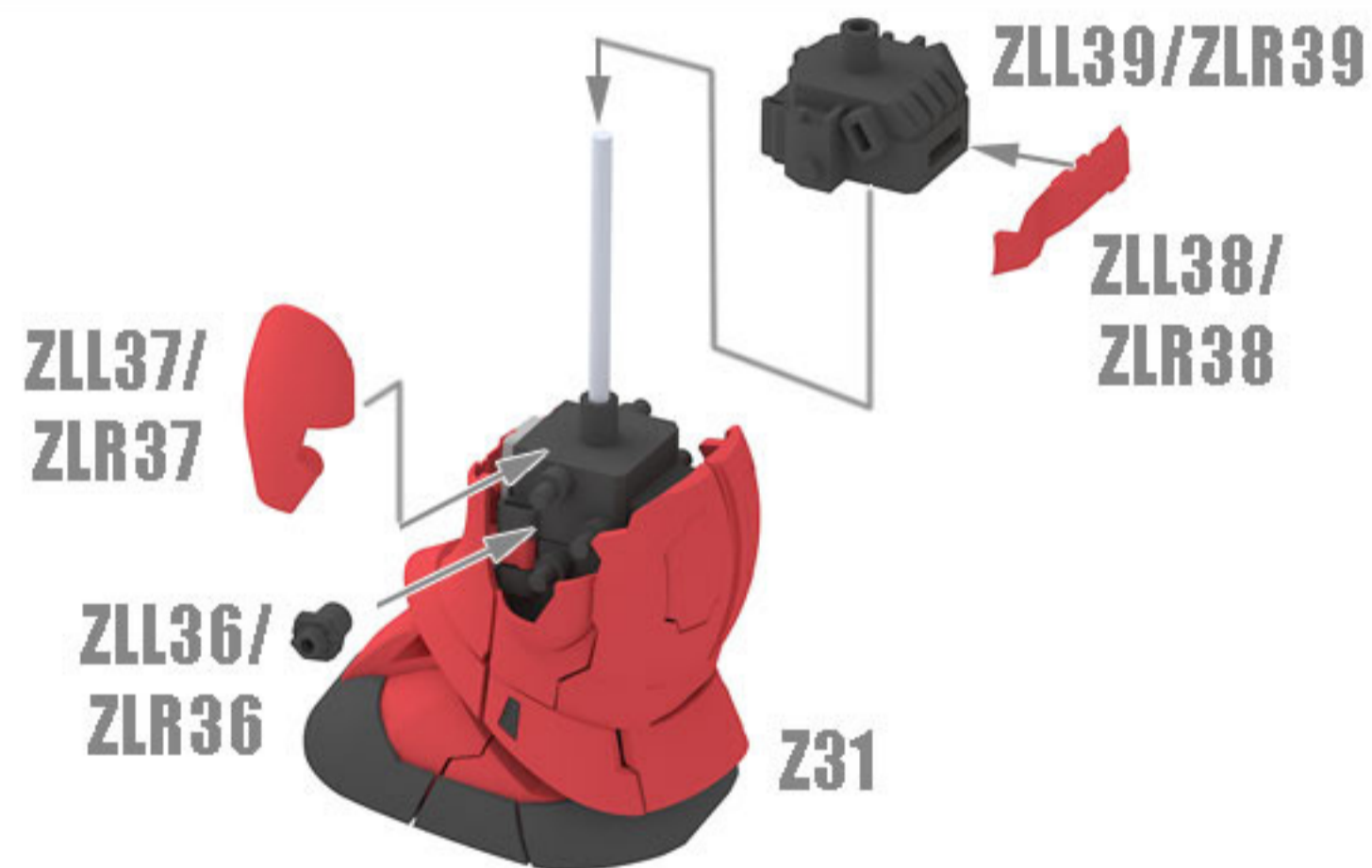
Z29**Z31****Z30****Z32**

DESIGN AND CREATED BY KAIEI3D 2023

2023 年由KAIEI3D 设计与建模

PLEASE RESPECT TO THE DESIGNER EFFORT DO NOT STEAL DESIGN

请尊重设计师，切勿偷盗别人的设计

WARNING : Pirate pictures must be investigated 盗图必究

KAIEI3D
TOYS · GADGET · HOBBY

06 3D PRINT 1:20
MS06 ZAKU-II

Z33

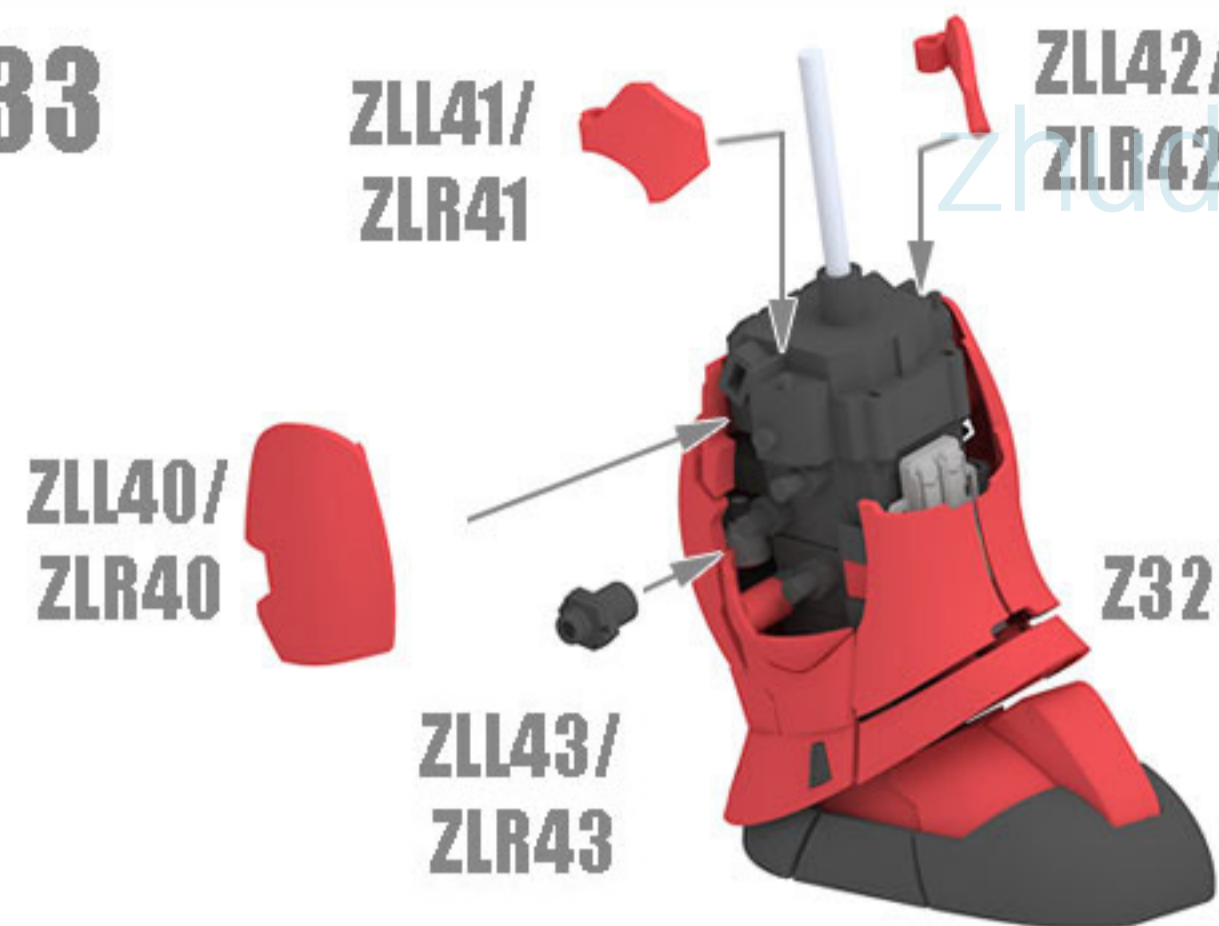

Z35

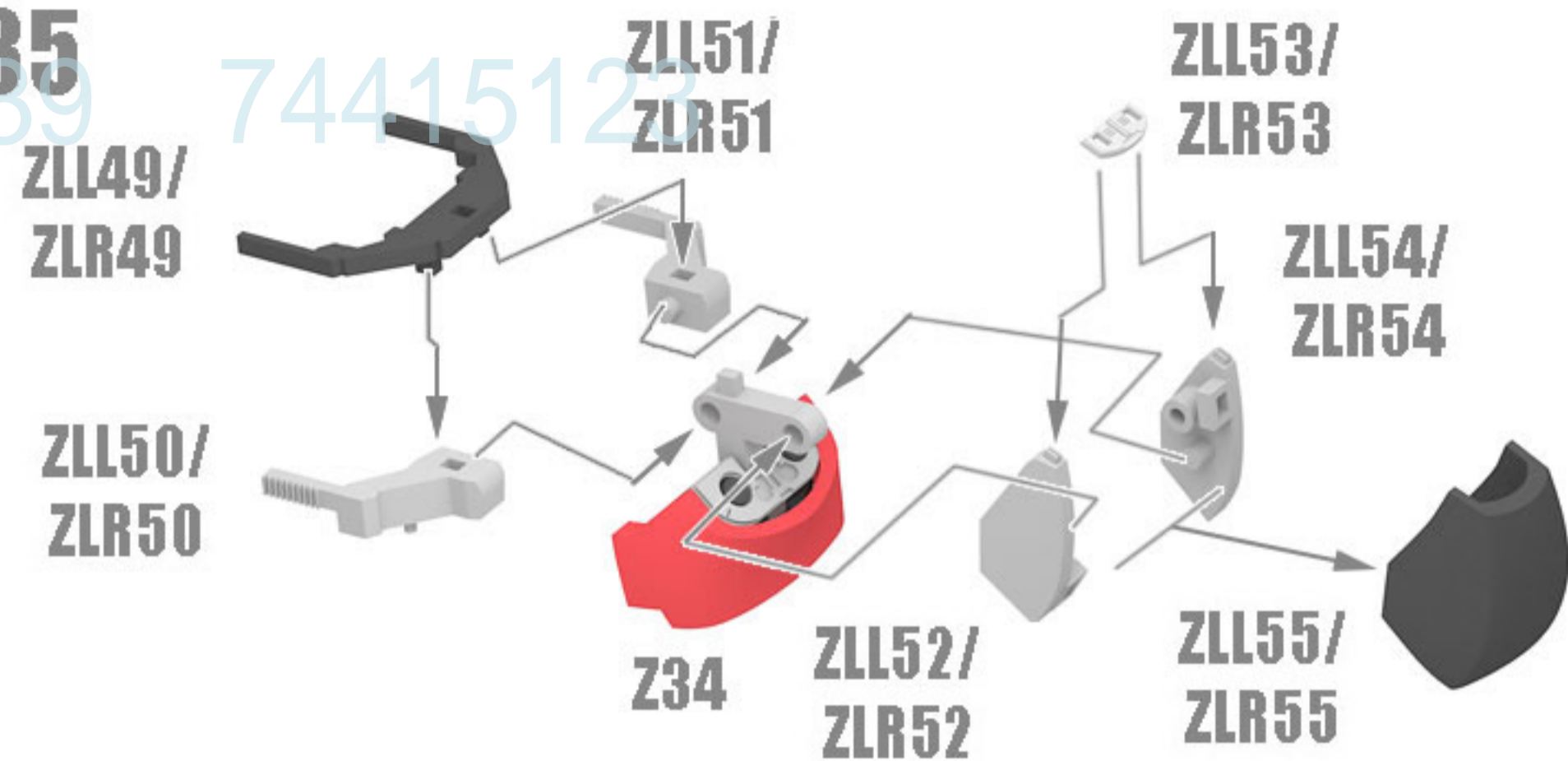

Z34

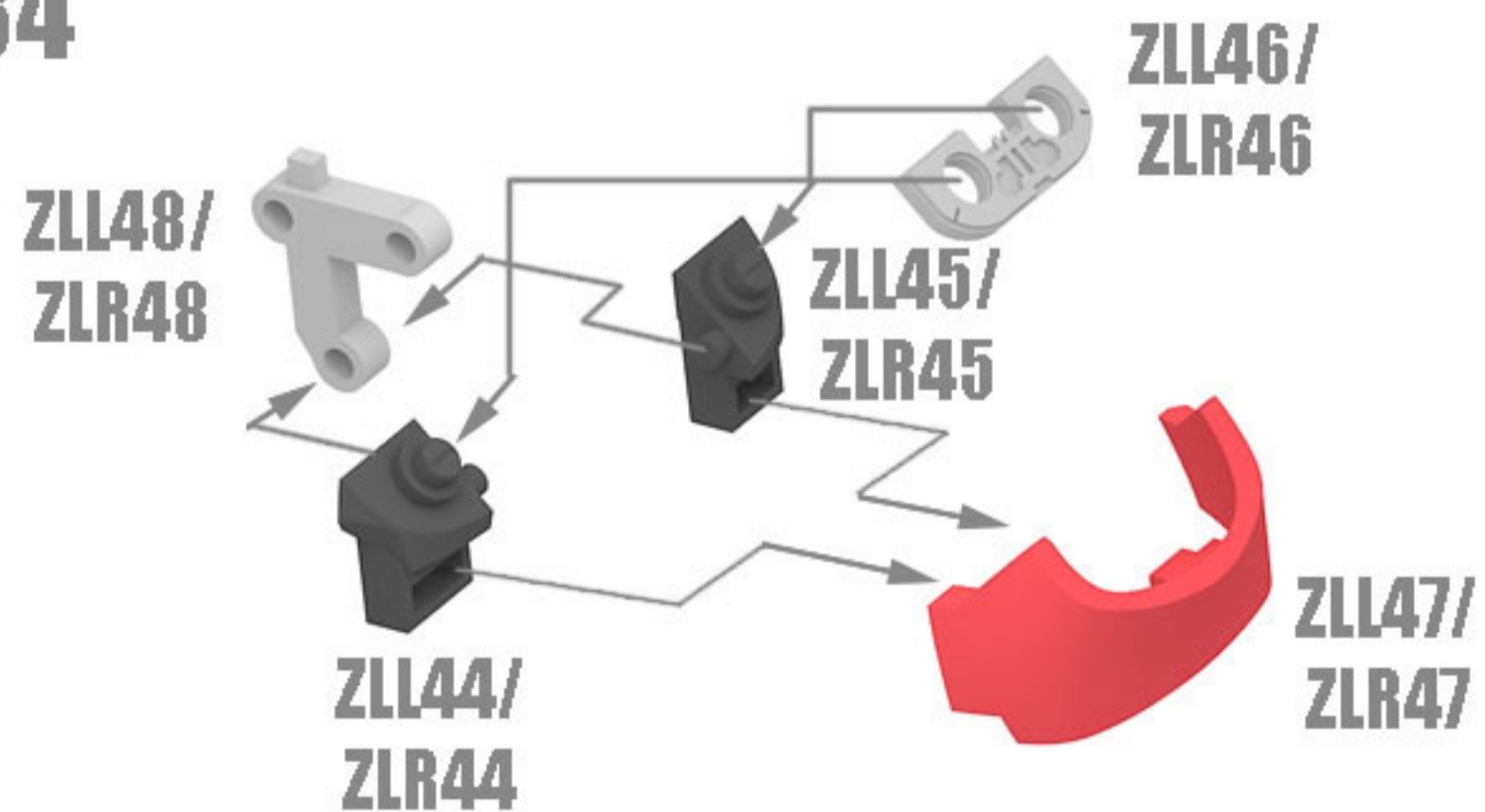

Z36

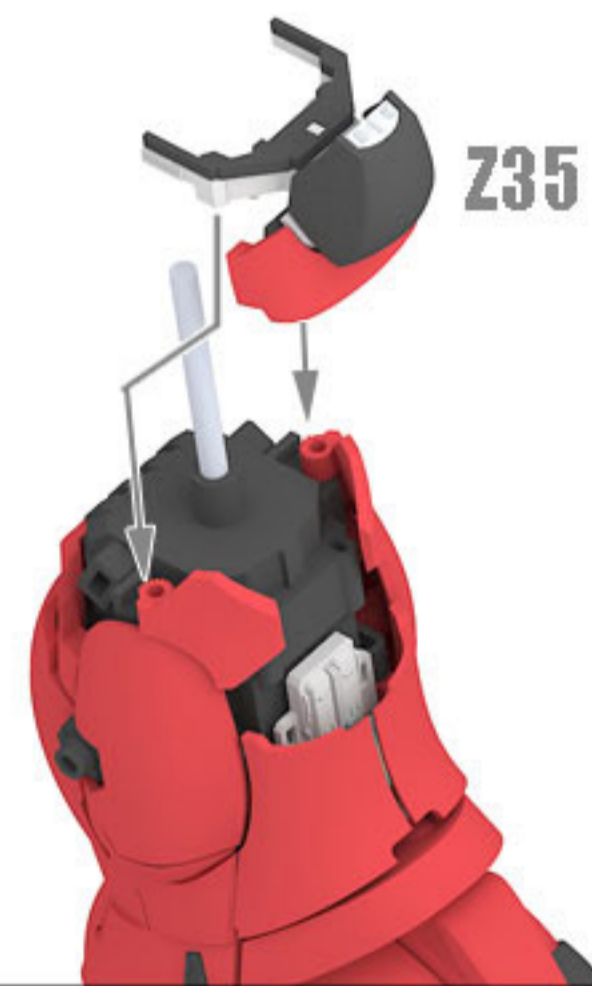

DESIGN AND CREATED BY KAIEI3D 2023

2023 年由KAIEI3D 设计与建模

PLEASE RESPECT TO THE DESIGNER EFFORT DO NOT STEAL DESIGN

请尊重设计师，切勿偷盗别人的设计

WARNING : Pirate pictures must be investigated 盗图必究

KAIEI3D
TOYS · GADGET · HOBBY

06 3D PRINT 1:20
MS06 ZAKU-II

Z37

ZLL56/
ZLR56

ZLL58/
ZLR58

ZLL57/
ZLR57

Z36



Z38

ZLL60/
ZLR60

ZLL59/
ZLR59

ZLL62/
ZLR62

ZLL61/
ZLR61

Z37

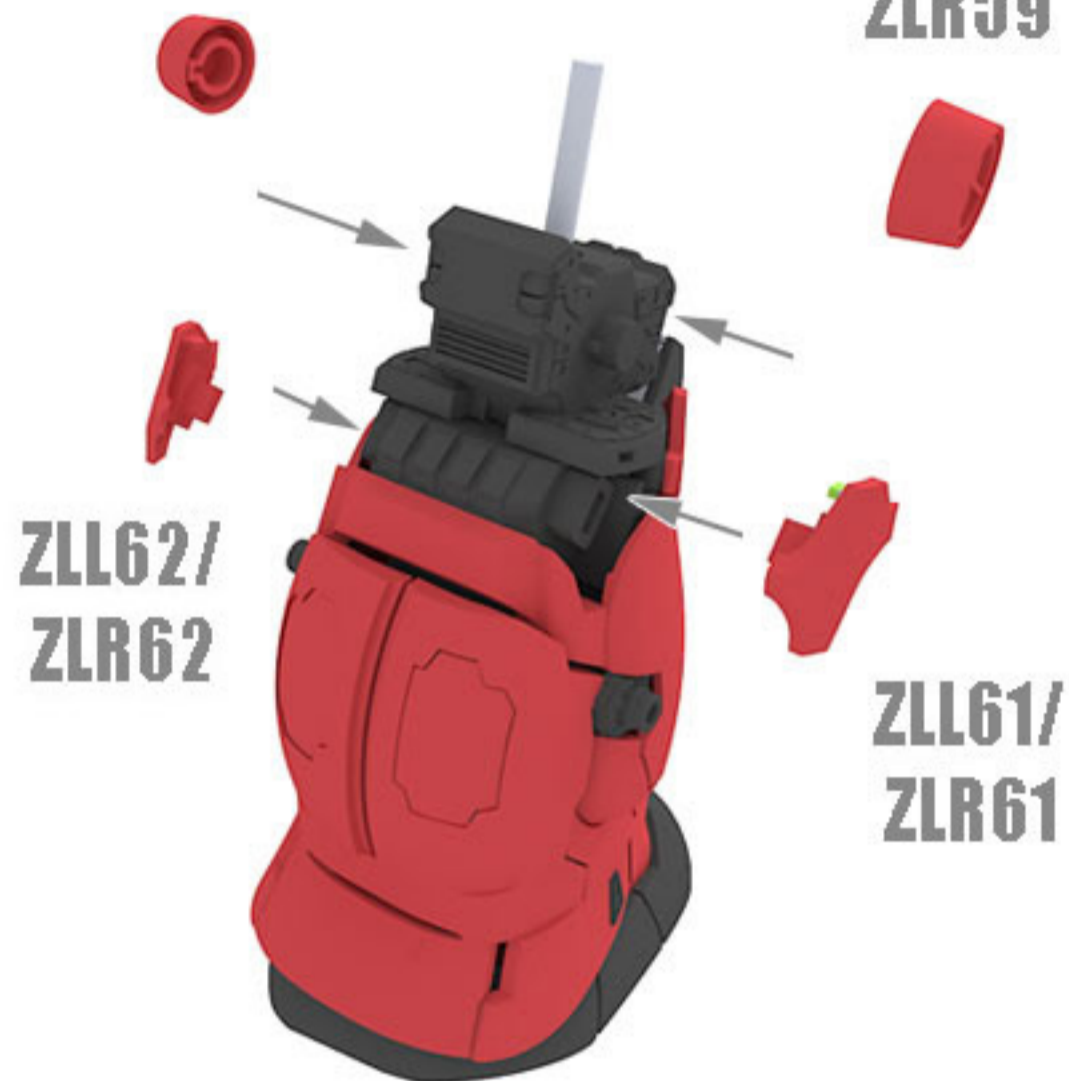

Z39

ZLL64/
ZLR64

ZLL66/
ZLR66

ZLL69/
ZLR69

ZLL67/
ZLR67

ZLL71/
ZLR71

ZLL70/
ZLR70

ZLL68/
ZLR68

ZLL63/
ZLR63

ZLL65/
ZLR65

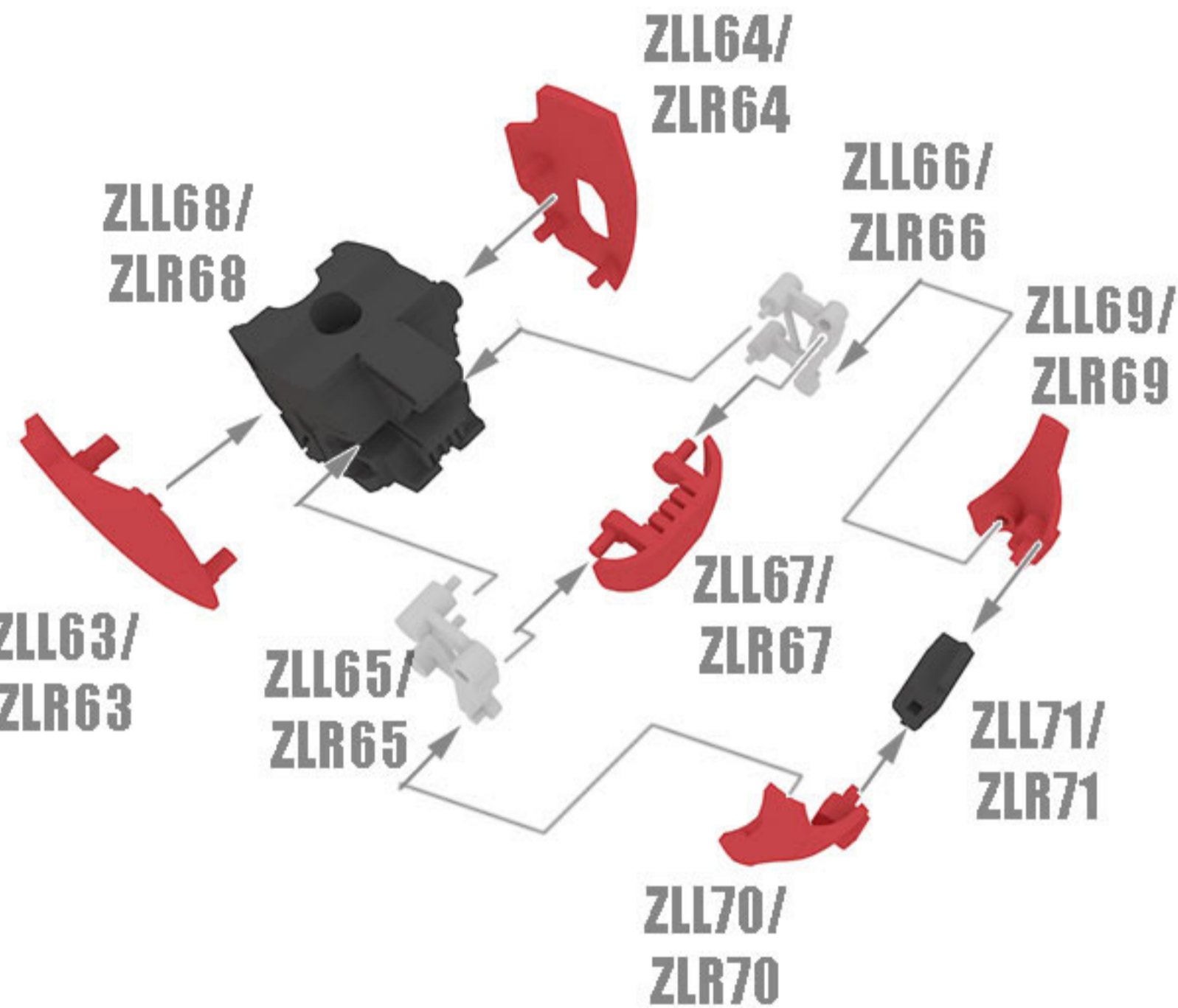

DESIGN AND CREATED BY KAIEI3D 2023

2023 年由KAIEI3D 设计与建模

PLEASE RESPECT TO THE DESIGNER EFFORT DO NOT STEAL DESIGN

请尊重设计师，切勿偷盗别人的设计

WARNING : Pirate pictures must be investigated 盗图必究

KAIEI3D

TOYS · GADGET · HOBBY

06
MS06 ZAKU-II

3D PRINT 1:20

Z40

ZLL74/
ZLR74

ZLL72/
ZLR72

ZLL73/
ZLR73

ZLL75/
ZLR75

ZLL76/
ZLR76

ZLL77/
ZLR77

ZLL78/
ZLR78

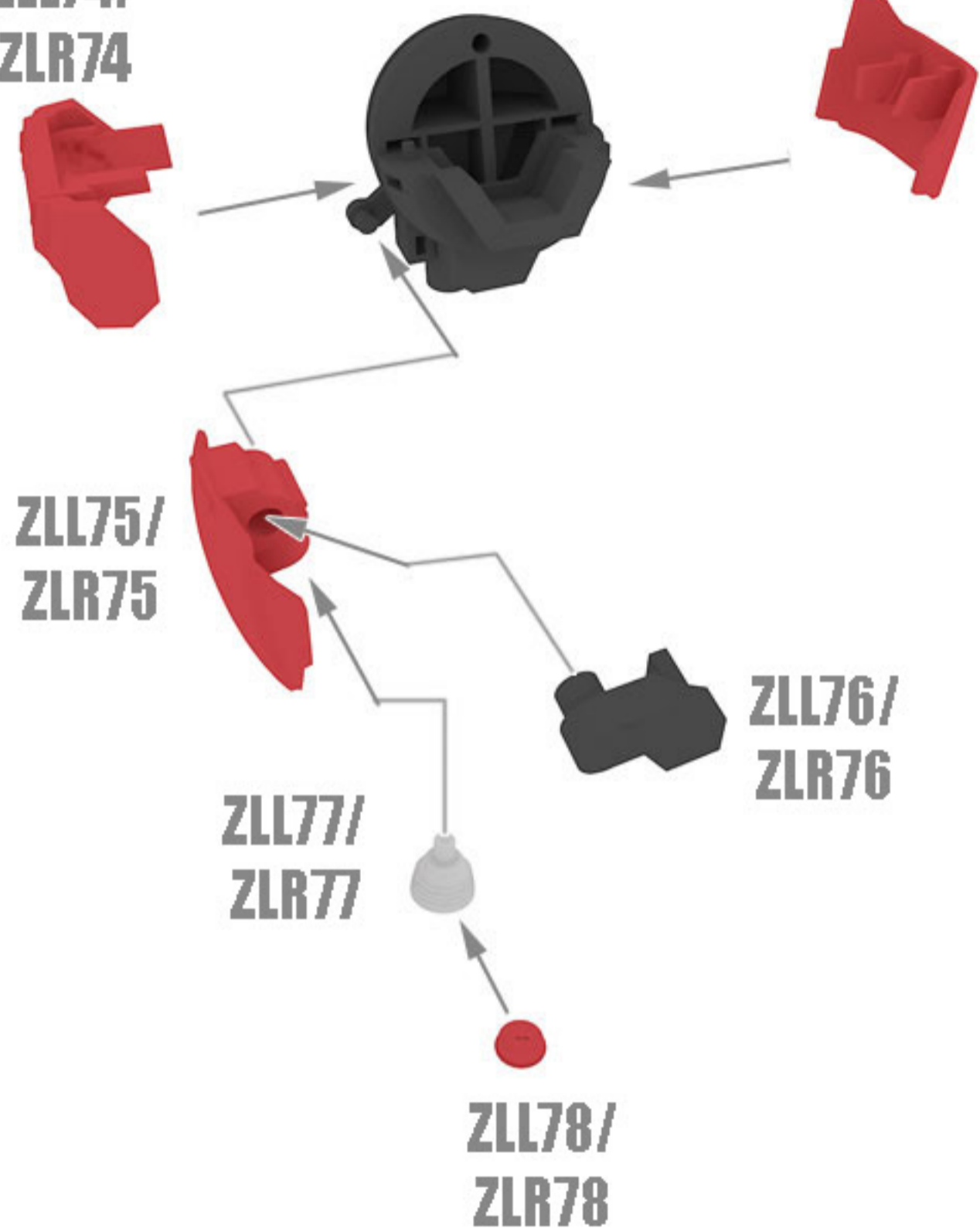

Z41

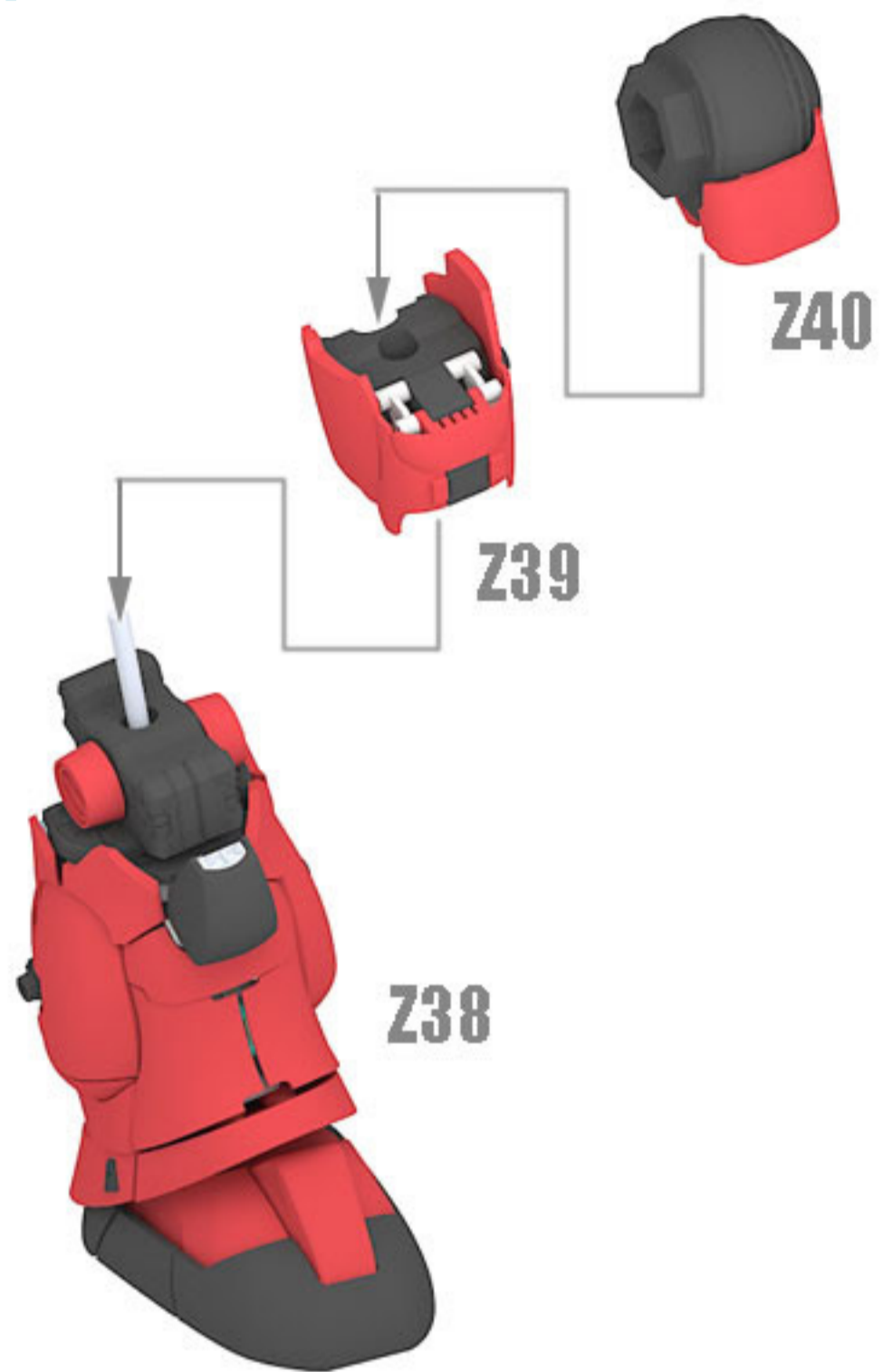

Z42

HC7

HC8

HC2

HC2

HC3 x9

HC6 x8



Z43

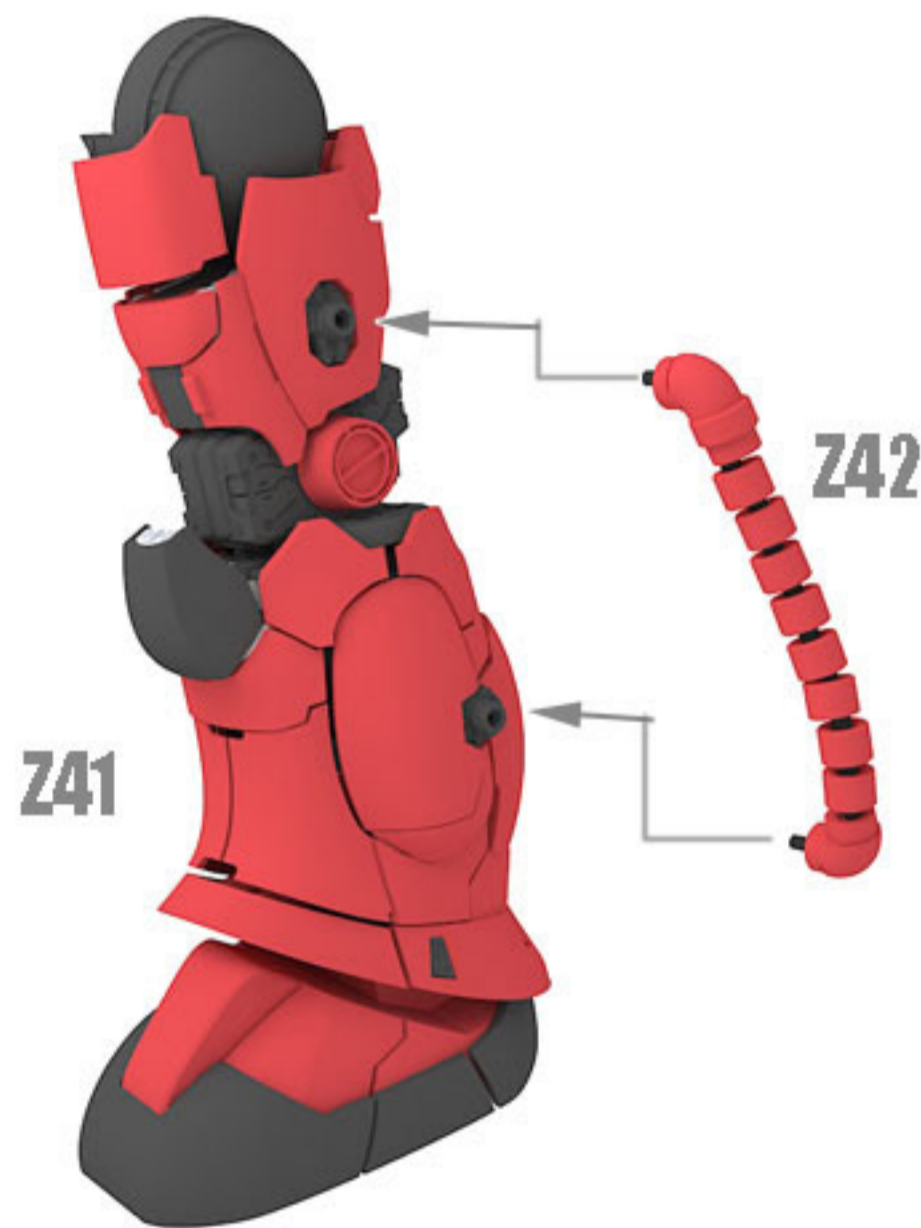

DESIGN AND CREATED BY KAIEI3D 2023

2023 年由KAIEI3D 设计与建模

PLEASE RESPECT TO THE DESIGNER EFFORT DO NOT STEAL DESIGN

请尊重设计师，切勿偷盗别人的设计

WARNING : Pirate pictures must be investigated 盗图必究

KAIEI3D

TOYS · GADGET · HOBBY

06
MS06 ZAKU-II

3D PRINT 1:20

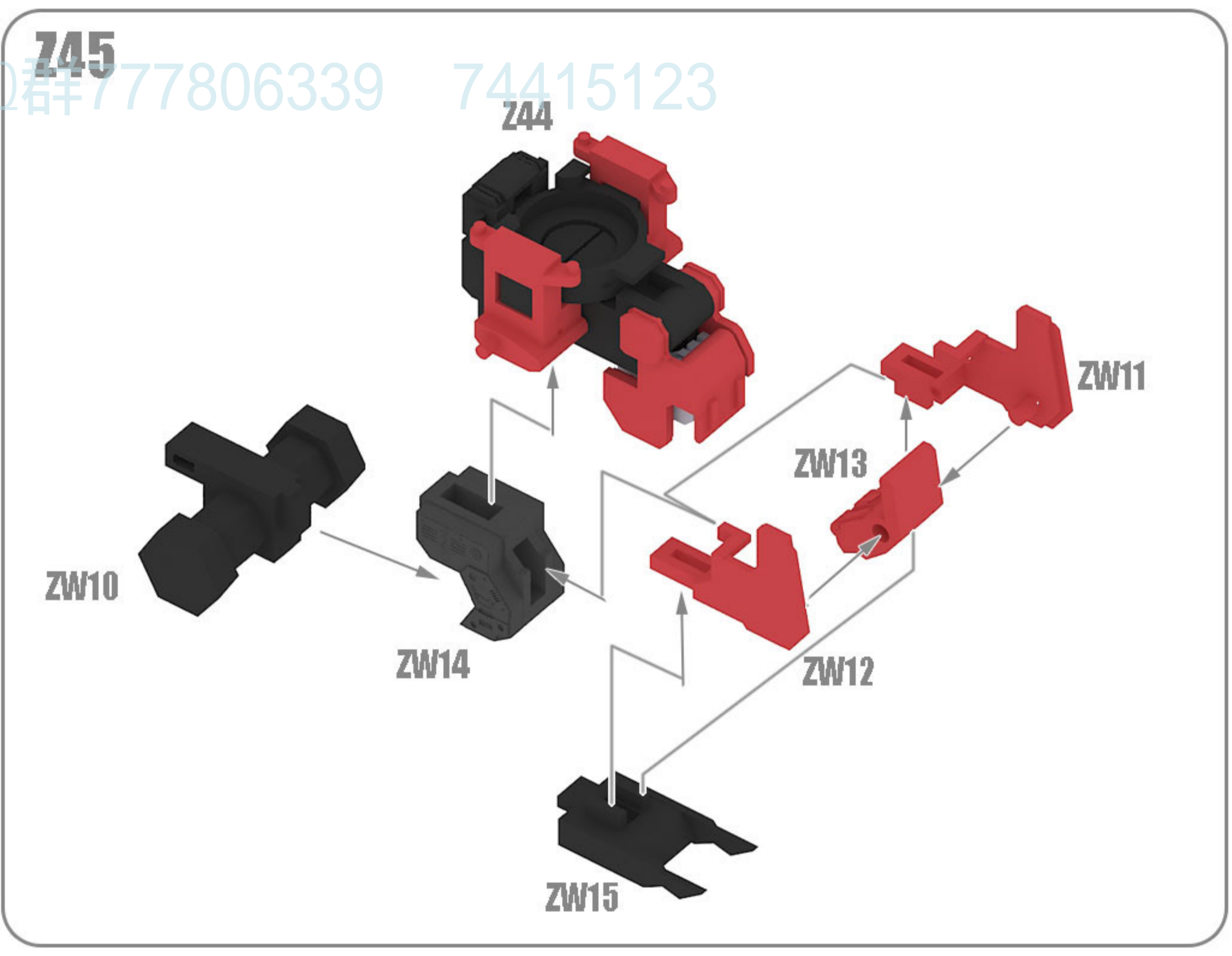
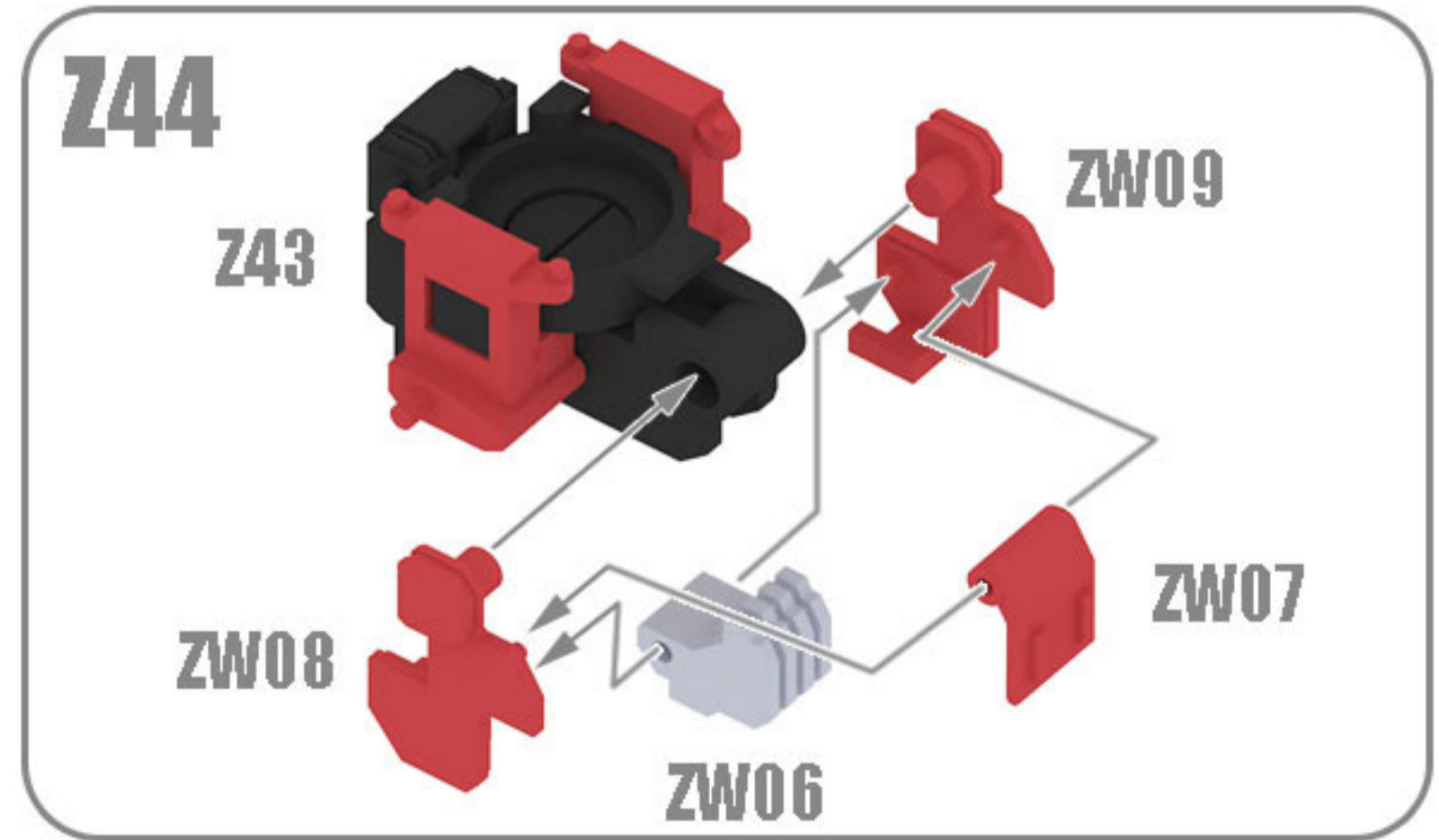
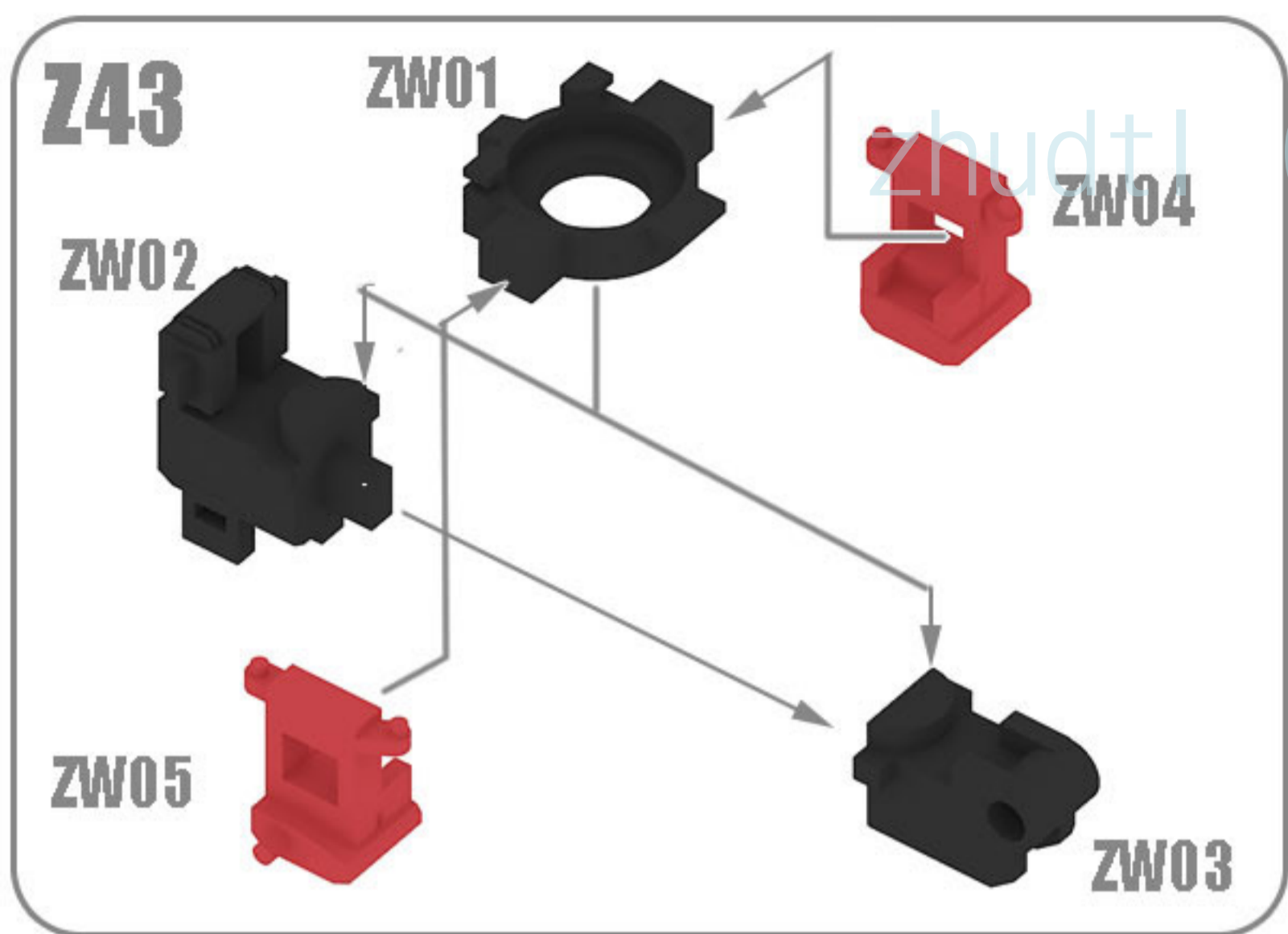

zhudt... Q群#777806339 74415123

DESIGN AND CREATED BY KAIEI3D 2023
 2023 年 由KAIEI3D 设计与建模
 PLEASE RESPECT TO THE DESIGNER EFFORT DO NOT STEAL DESIGN
 请尊重设计师，切勿偷盗别人的设计
 WARNING : Pirate pictures must be investigated 盗图必究



Z46

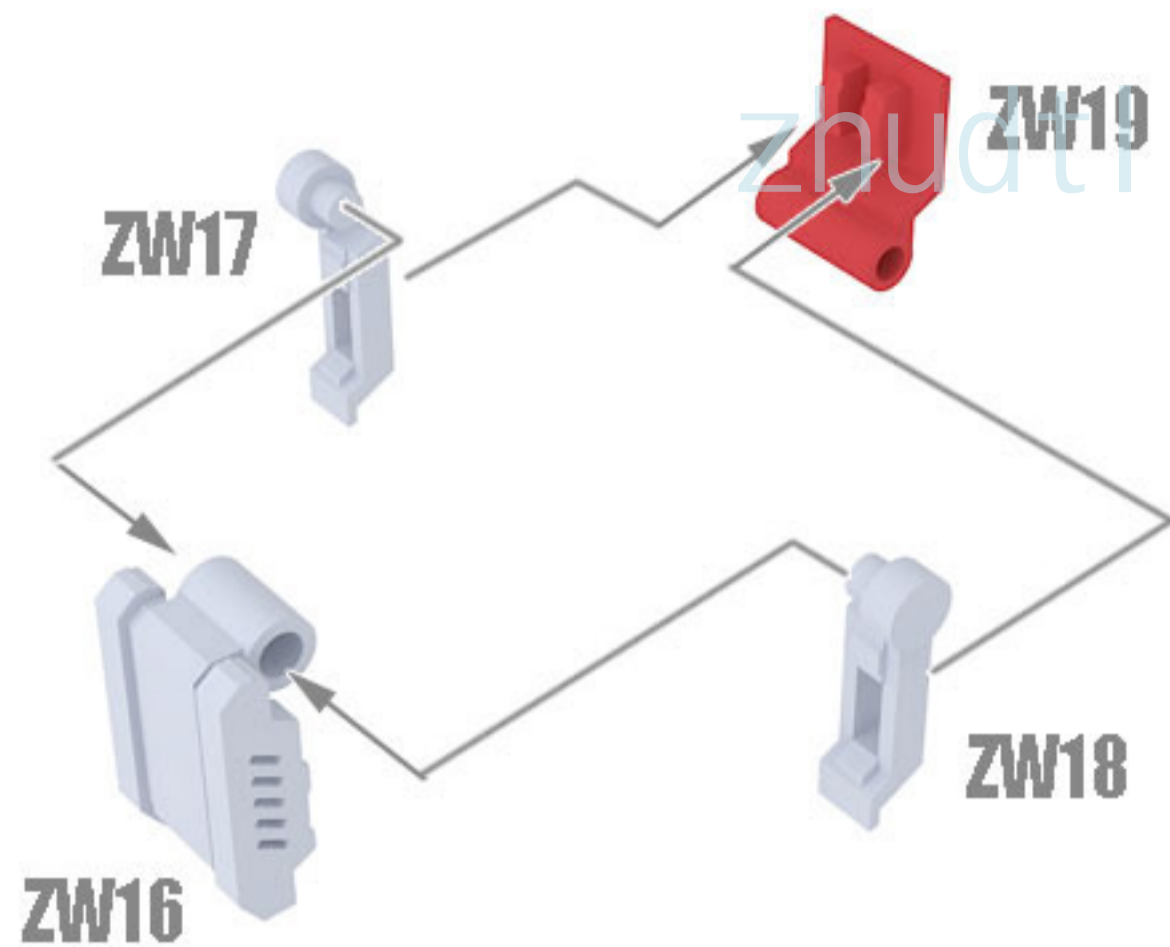

Z48

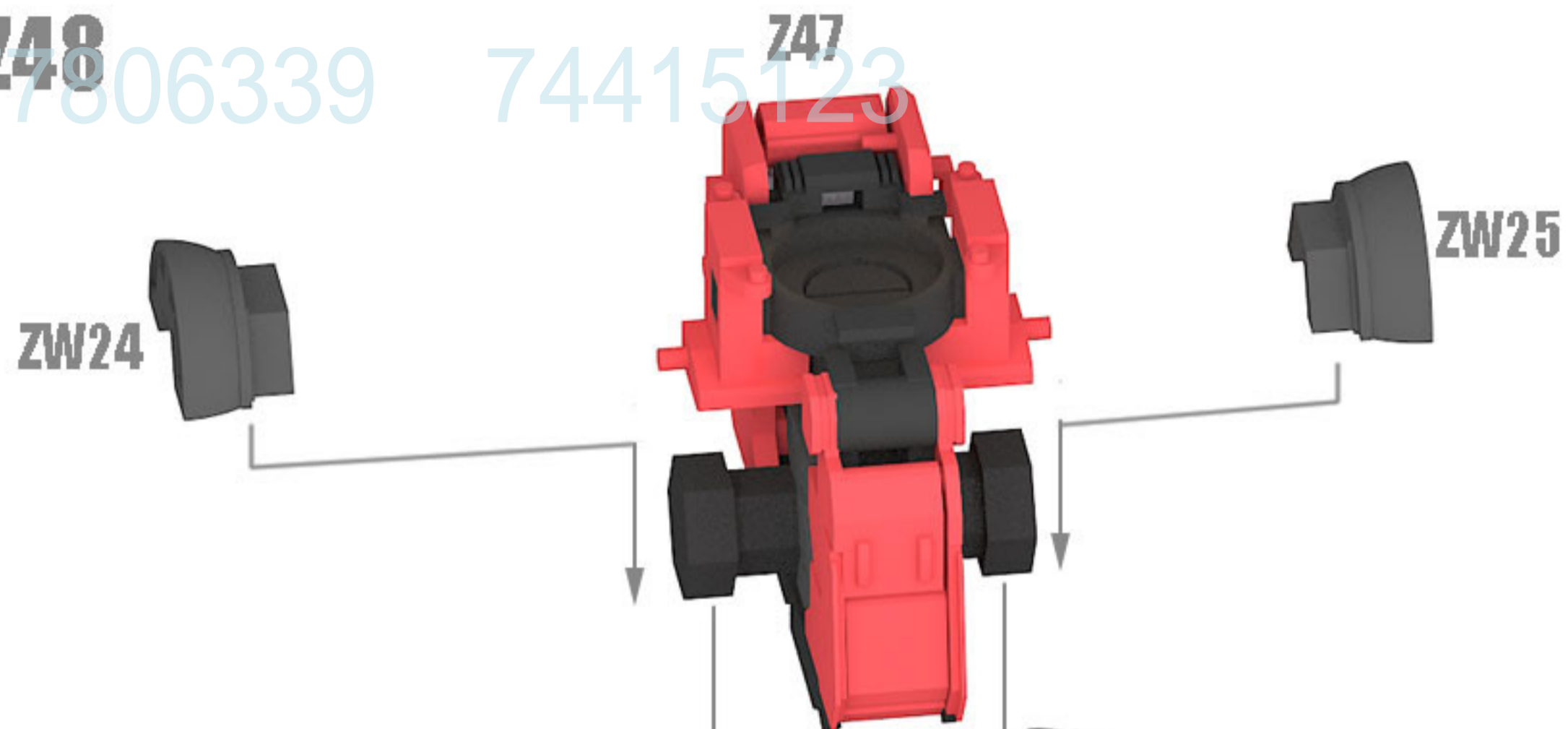

Z47

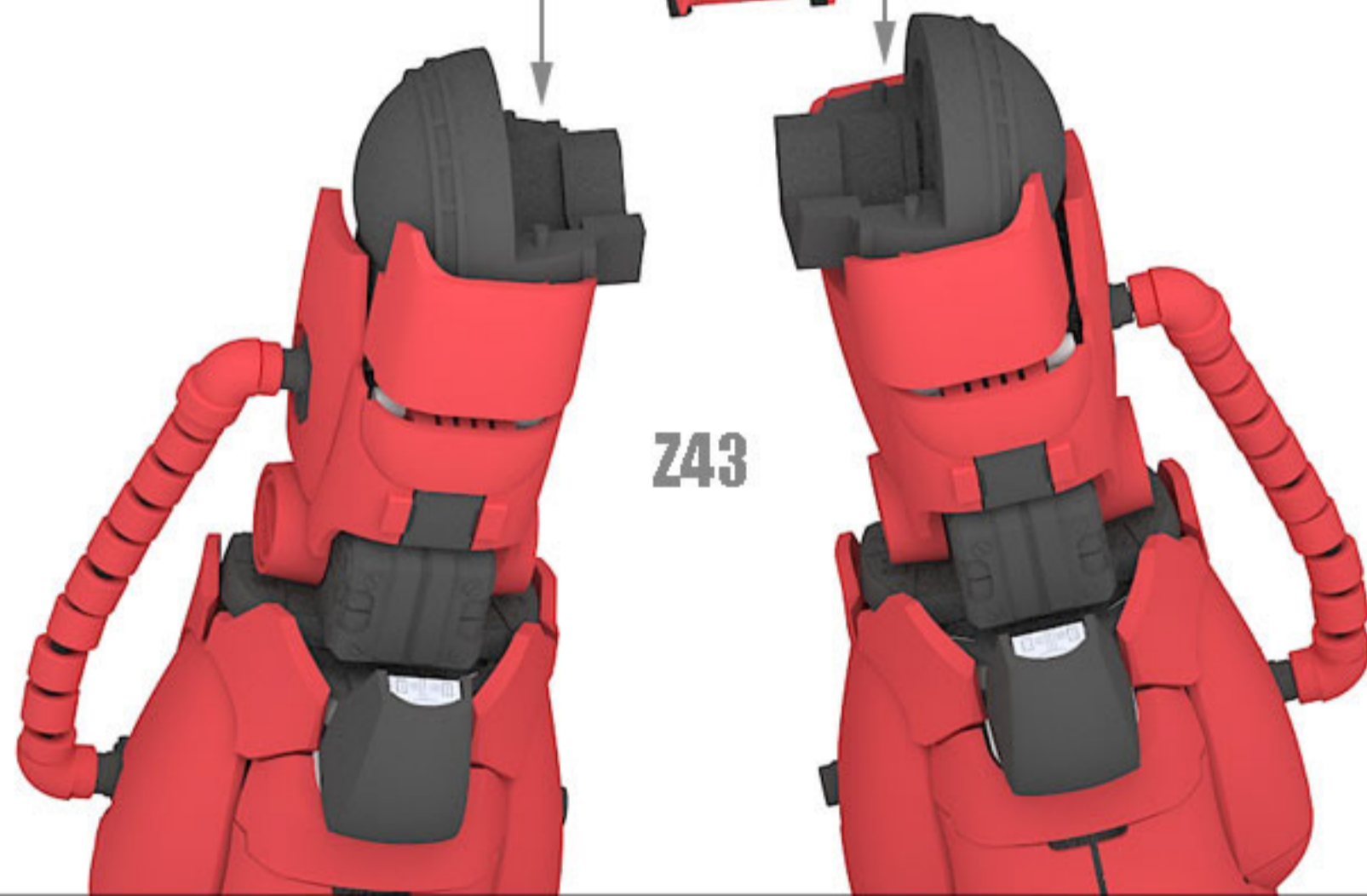
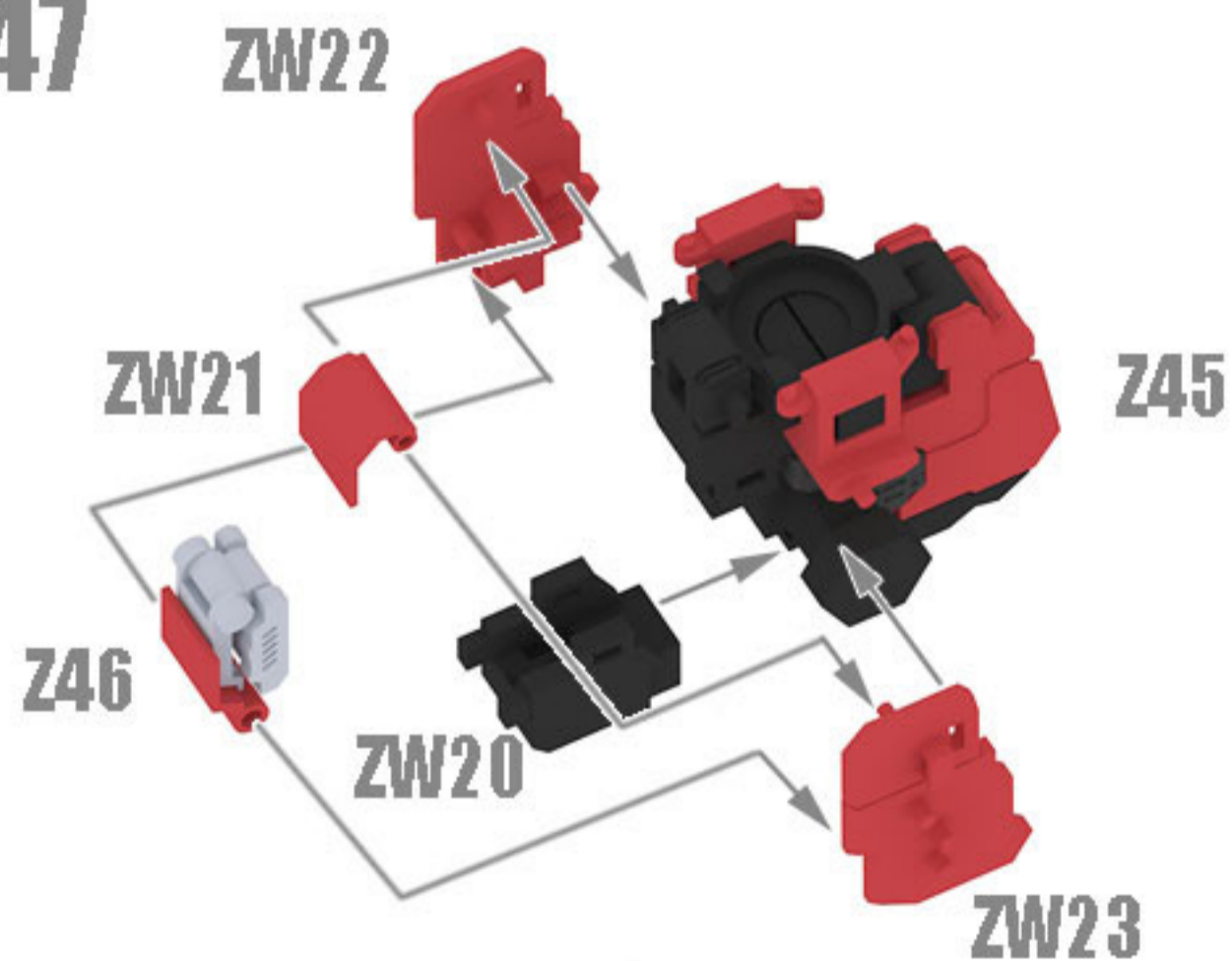

DESIGN AND CREATED BY KAIEI3D 2023

2023 年由KAIEI3D 设计与建模

PLEASE RESPECT TO THE DESIGNER EFFORT DO NOT STEAL DESIGN

请尊重设计师，切勿偷盗别人的设计

WARNING : Pirate pictures must be investigated 盗图必究

KAIEI3D

TOYS · GADGET · HOBBY

06
MS06 ZAKU-II

3D PRINT 1:20

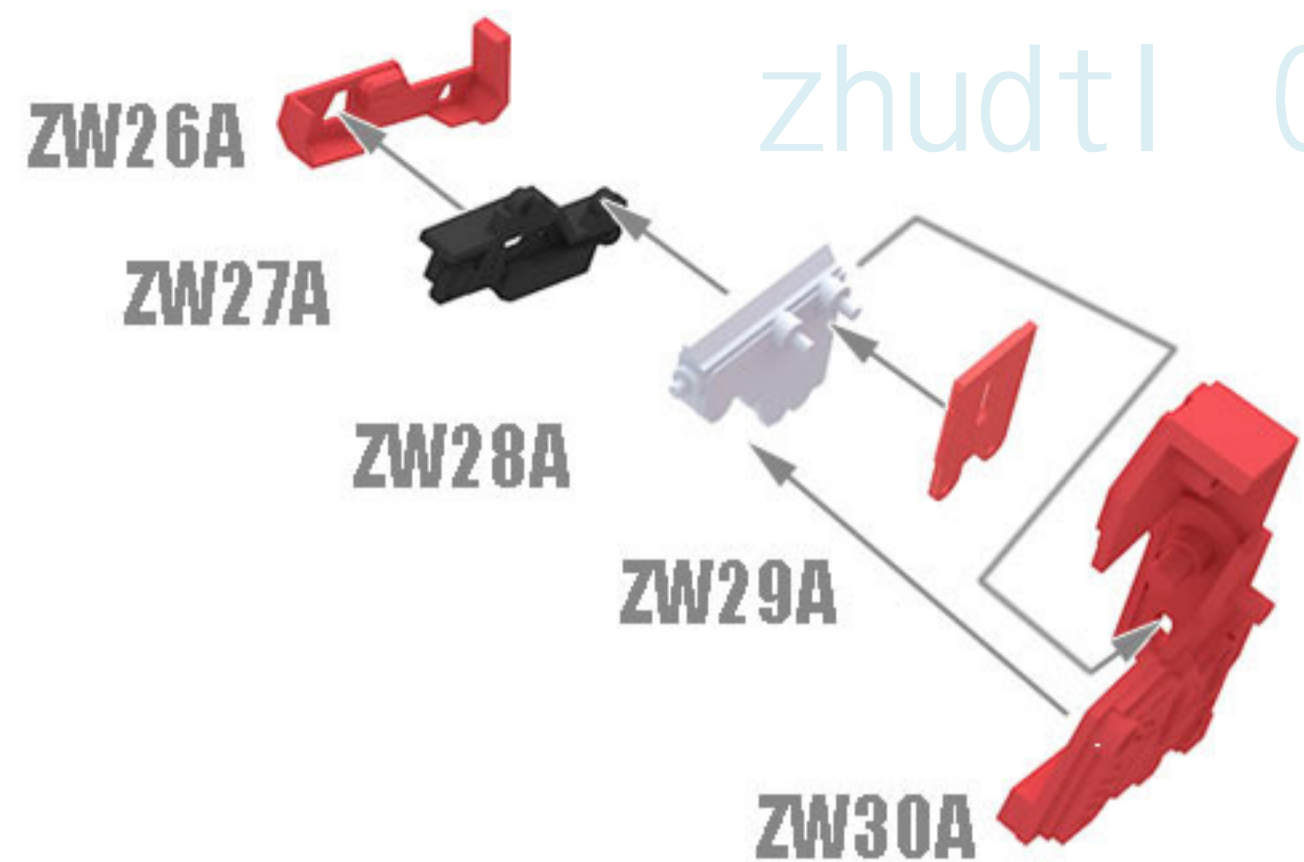
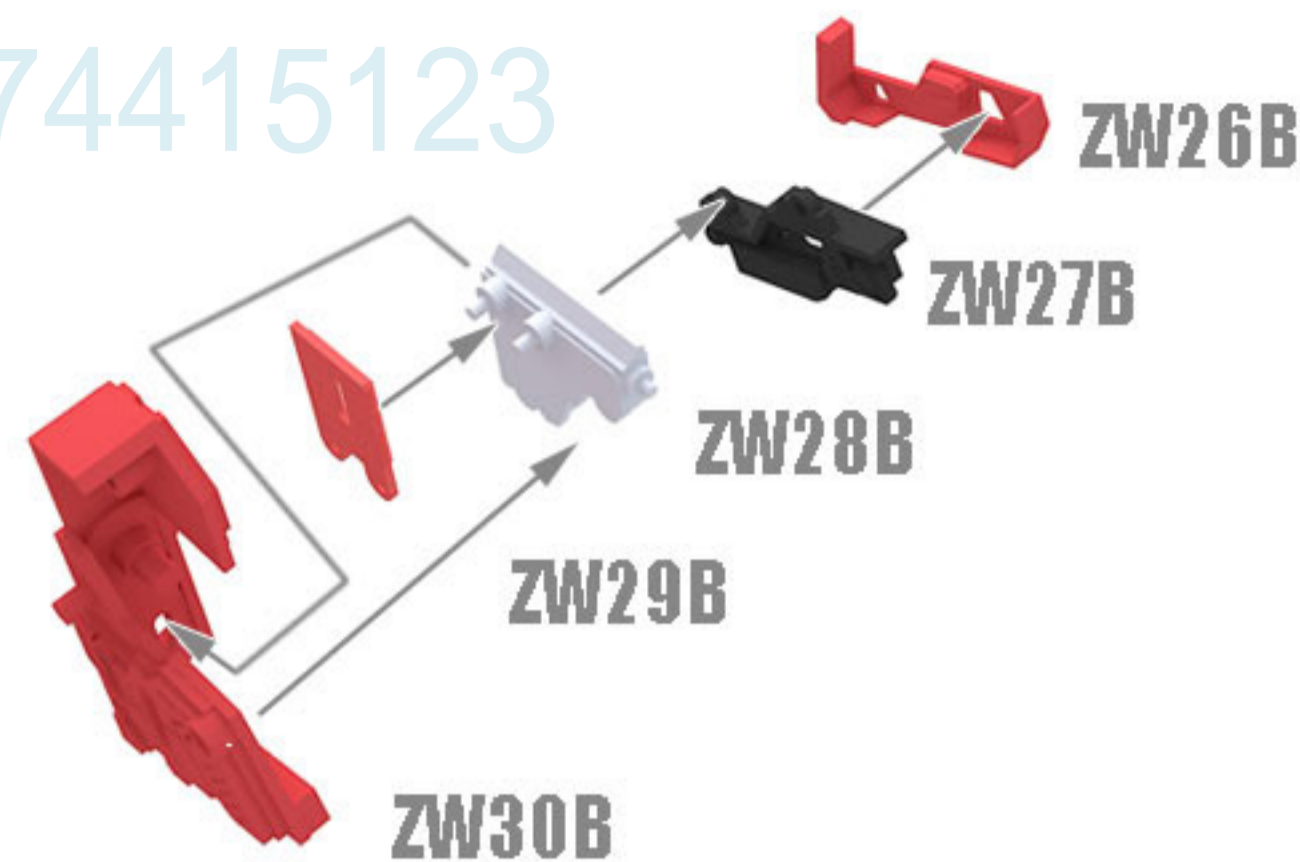
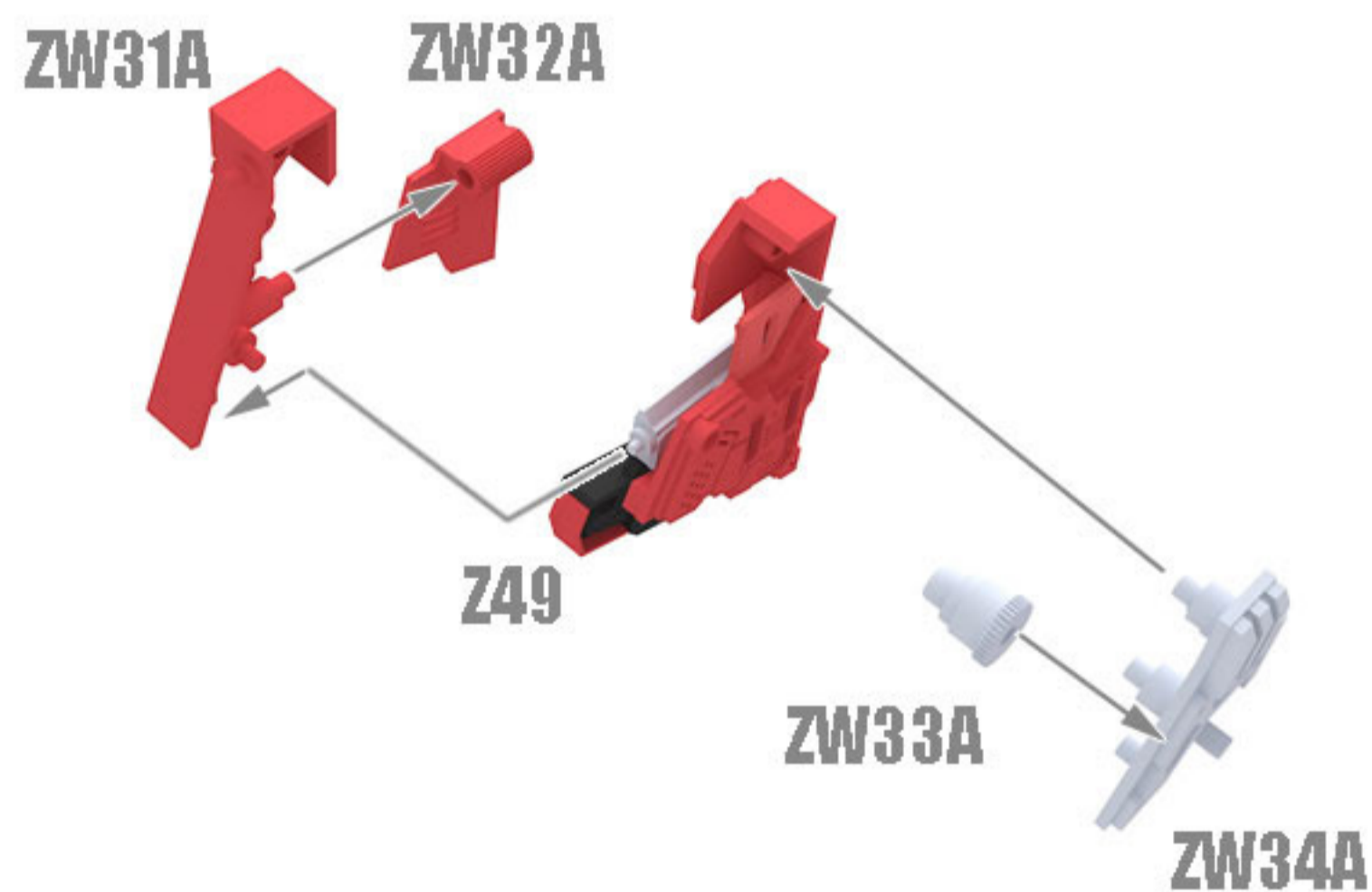
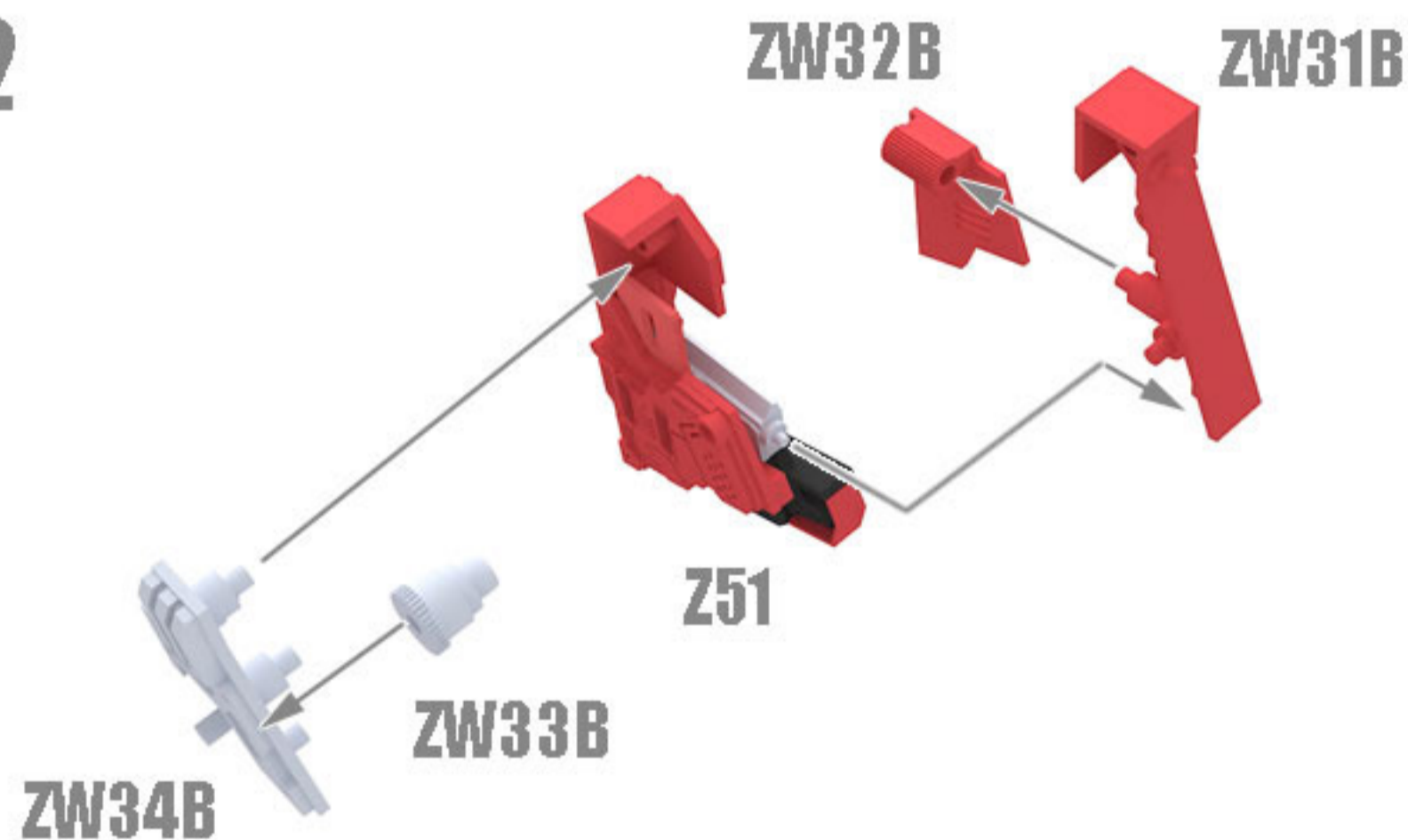
Z49**Z51****Z50****Z52**

DESIGN AND CREATED BY KAIEI3D 2023

2023 年由KAIEI3D 设计与建模

PLEASE RESPECT TO THE DESIGNER EFFORT DO NOT STEAL DESIGN

请尊重设计师，切勿偷盗别人的设计

WARNING : Pirate pictures must be investigated 盗图必究

KAIEI3D
TOYS · GADGET · HOBBY

06
MS06 ZAKU-II

3D PRINT 1:20

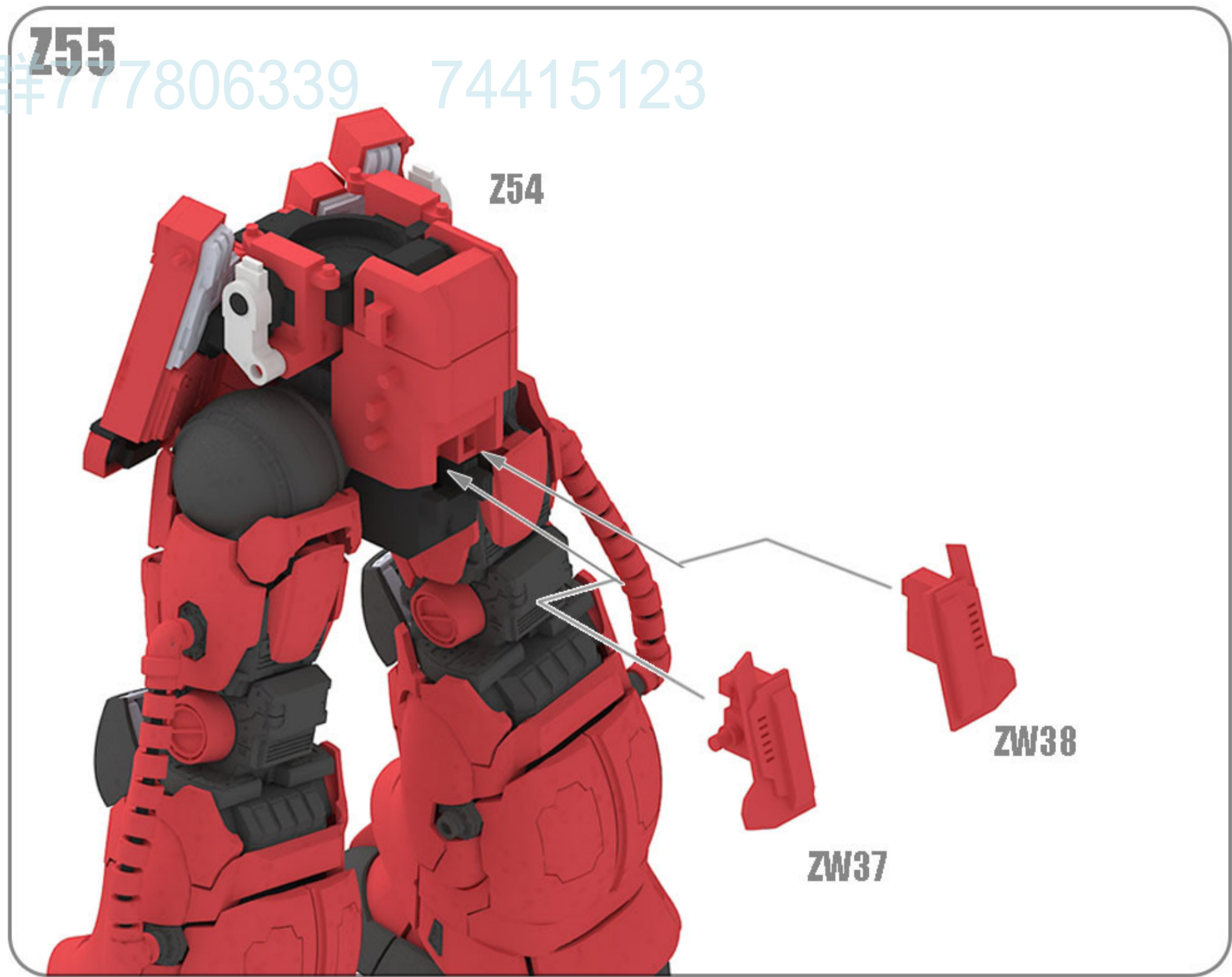
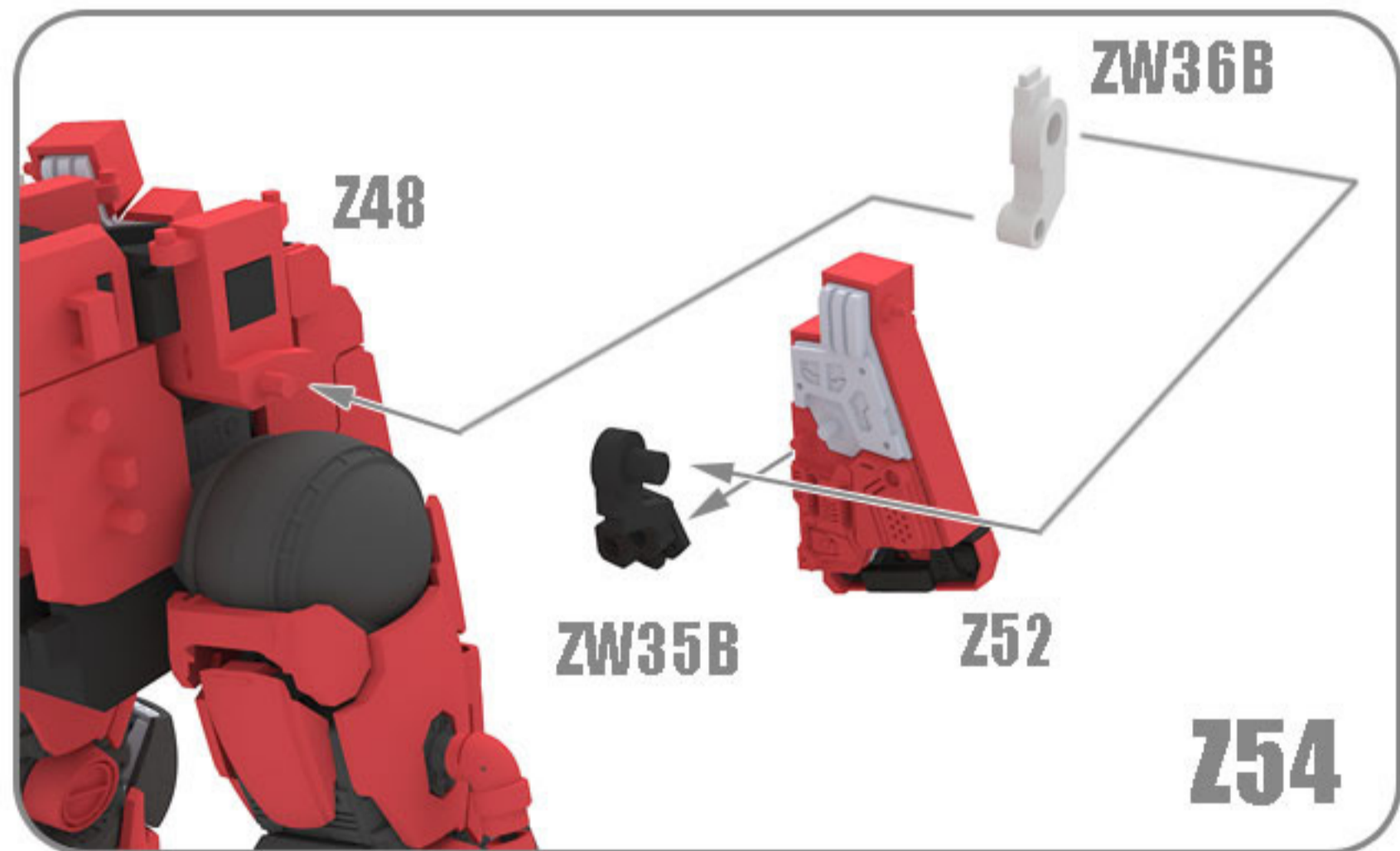
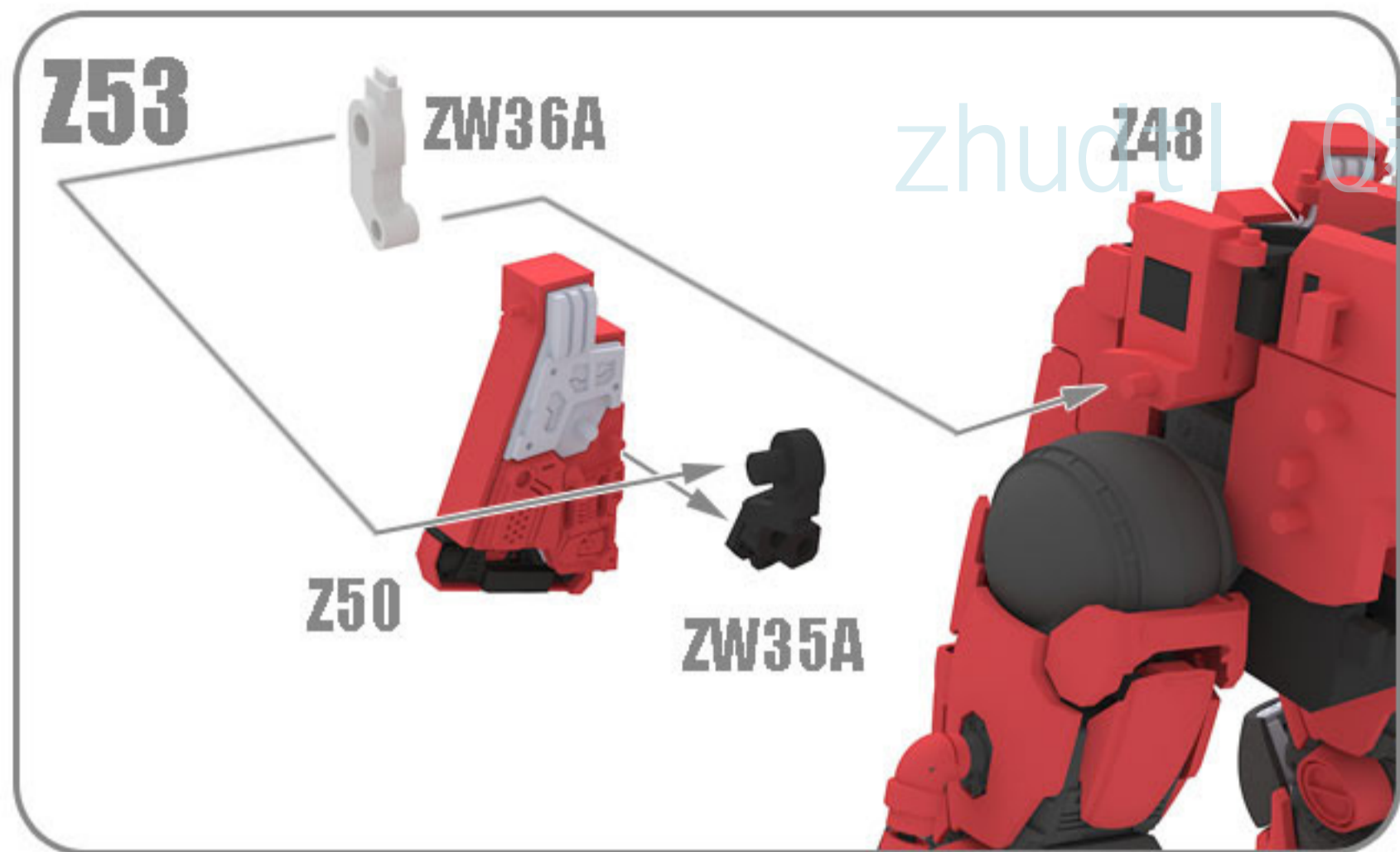

zhuoqi 群 777806339 74415123

DESIGN AND CREATED BY KAIEI3D 2023
 2023 年 由KAIEI3D 设计与建模
 PLEASE RESPECT TO THE DESIGNER EFFORT DO NOT STEAL DESIGN
 请尊重设计师，切勿偷盗别人的设计
 WARNING : Pirate pictures must be investigated 盗图必究



Z56

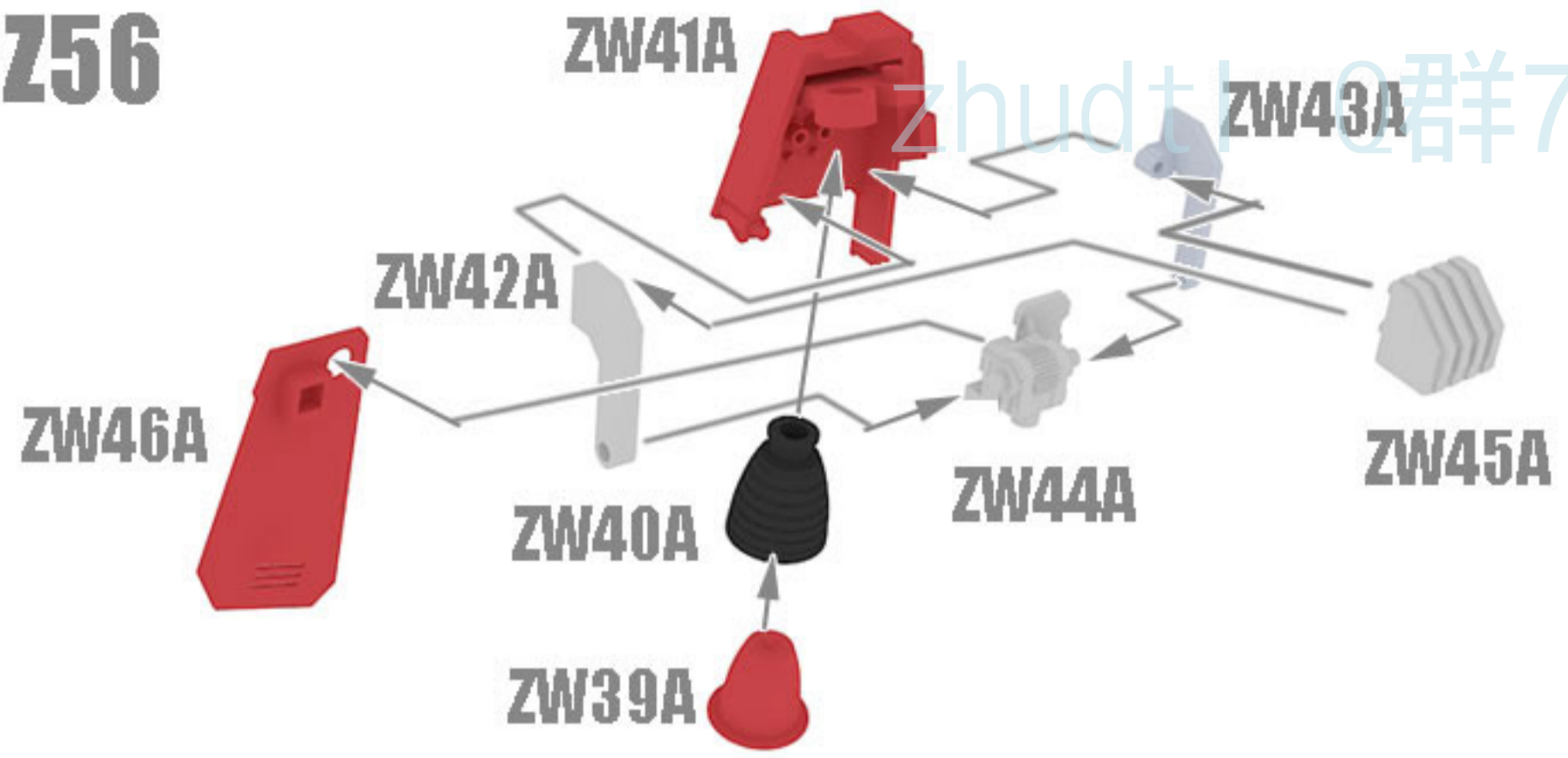

Z58

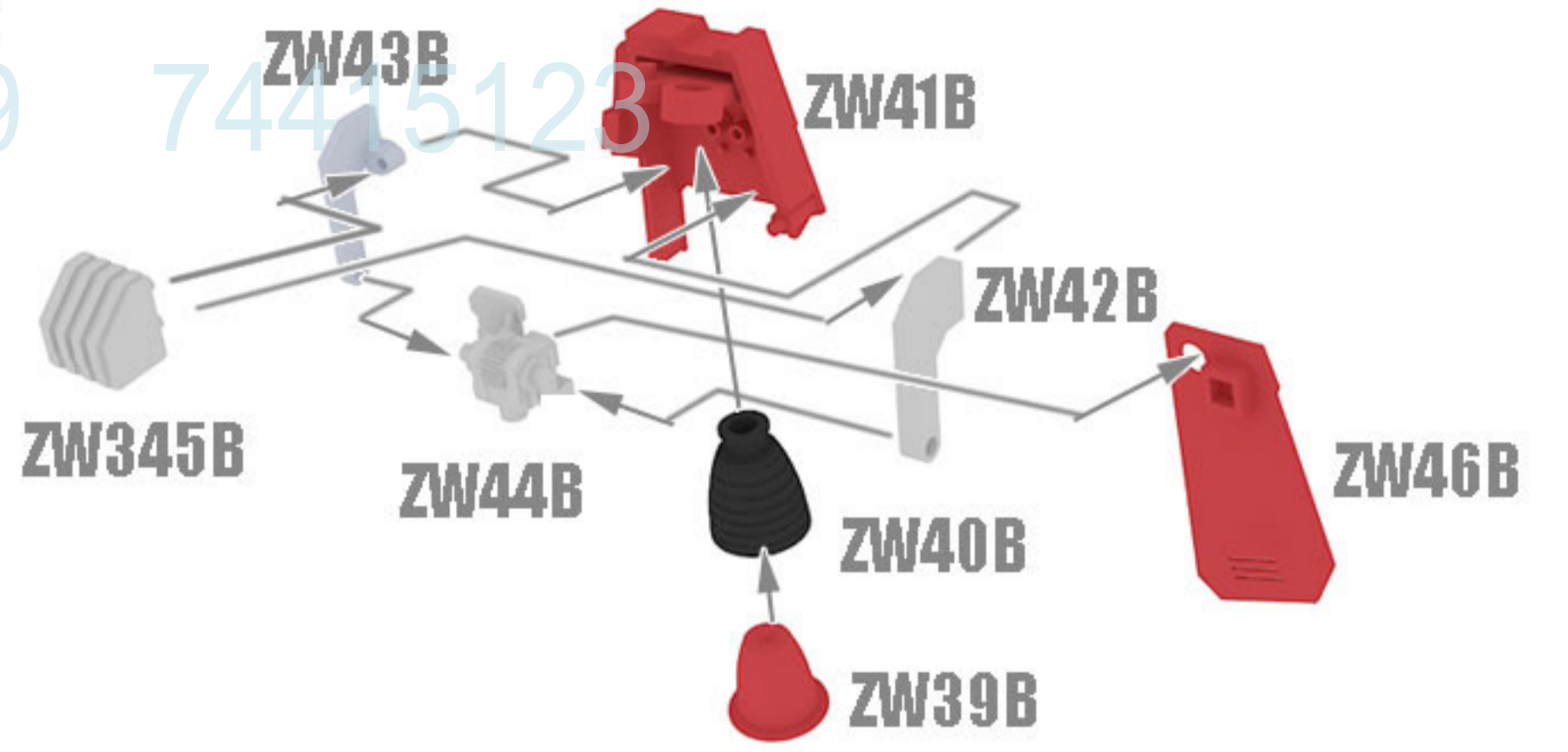

Z57

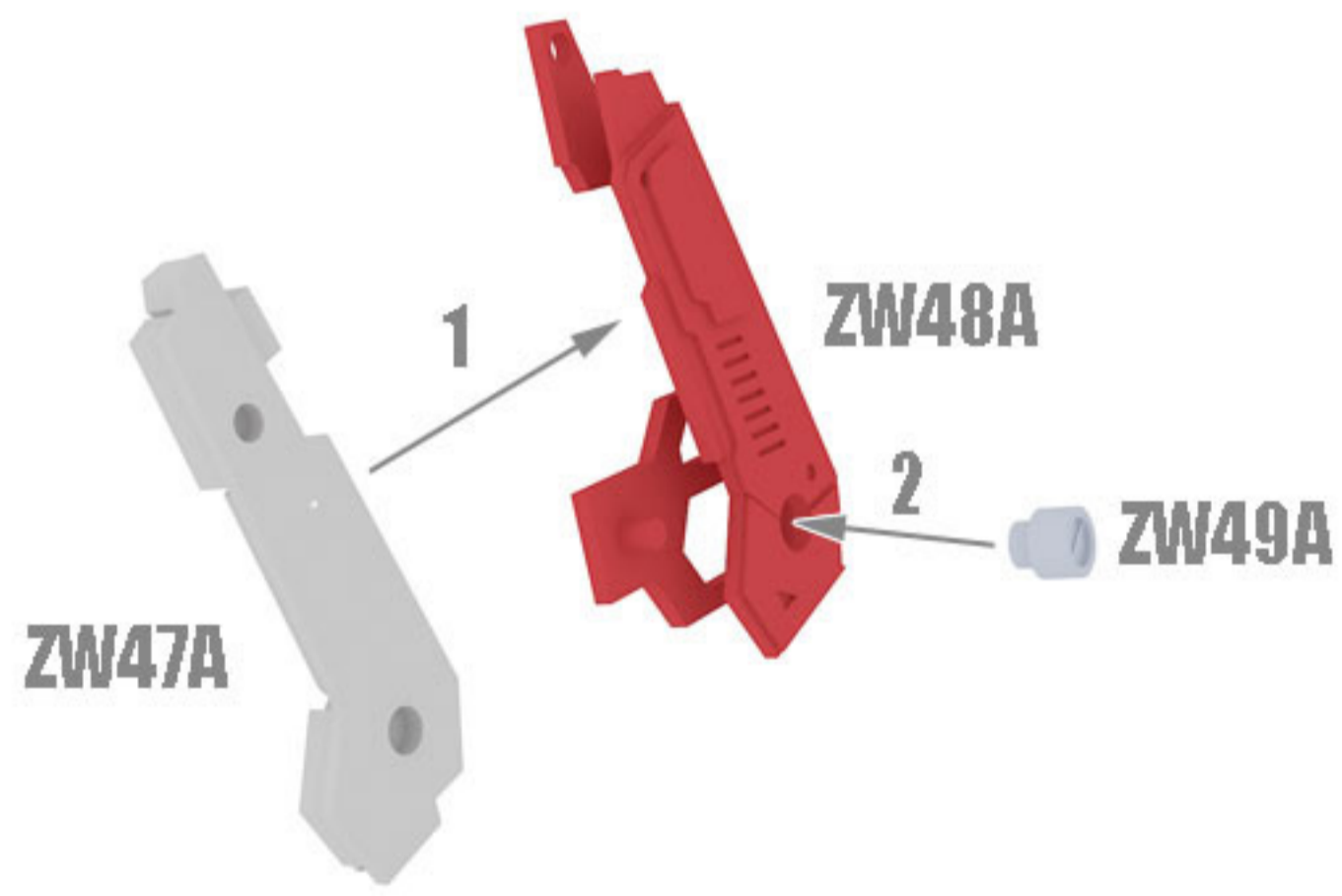

Z59

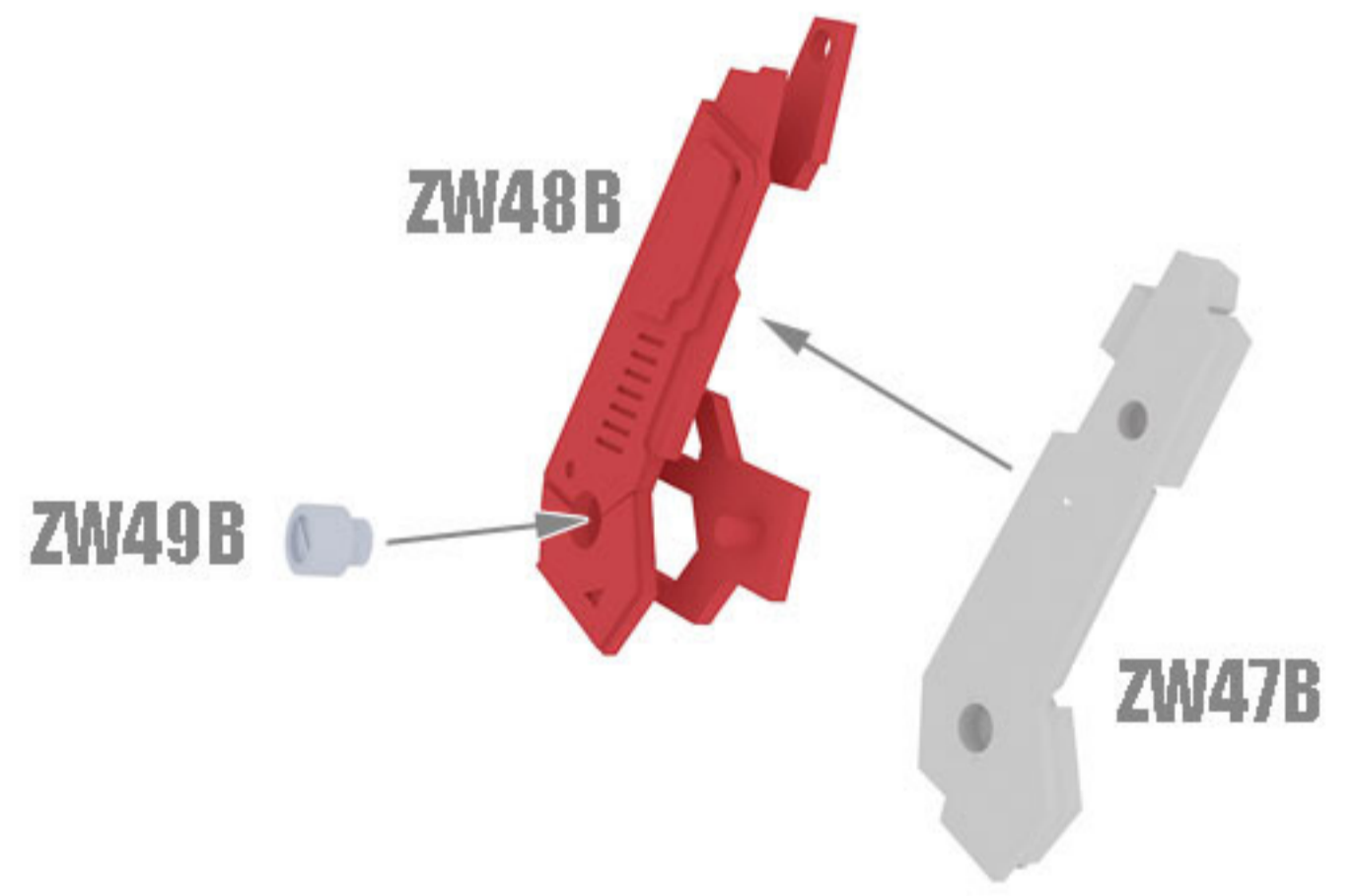

DESIGN AND CREATED BY KAIEI3D 2023

2023 年由KAIEI3D 设计与建模

PLEASE RESPECT TO THE DESIGNER EFFORT DO NOT STEAL DESIGN

请尊重设计师，切勿偷盗别人的设计

WARNING : Pirate pictures must be investigated 盗图必究



zhudtl Q群777806339 74415123

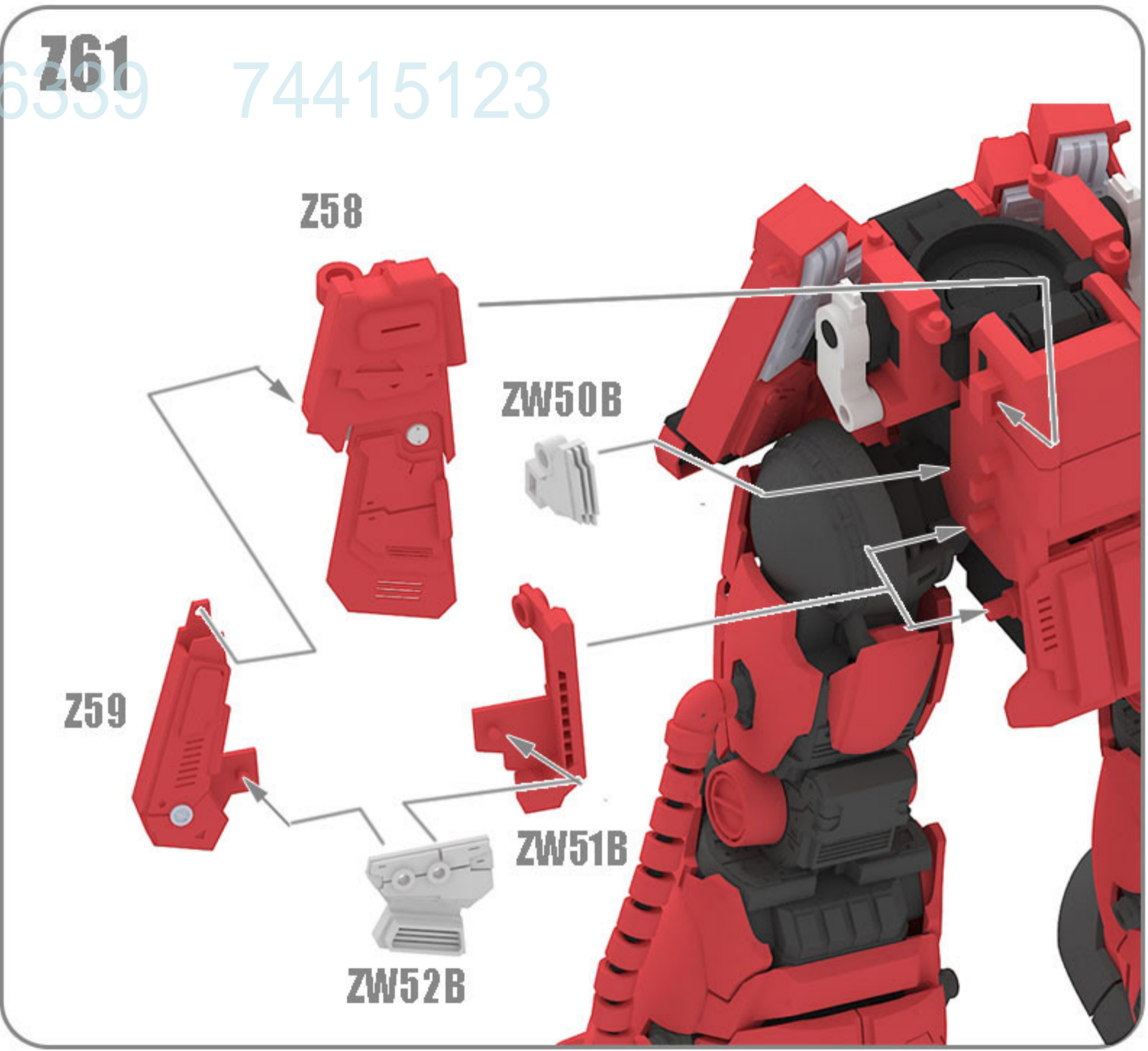
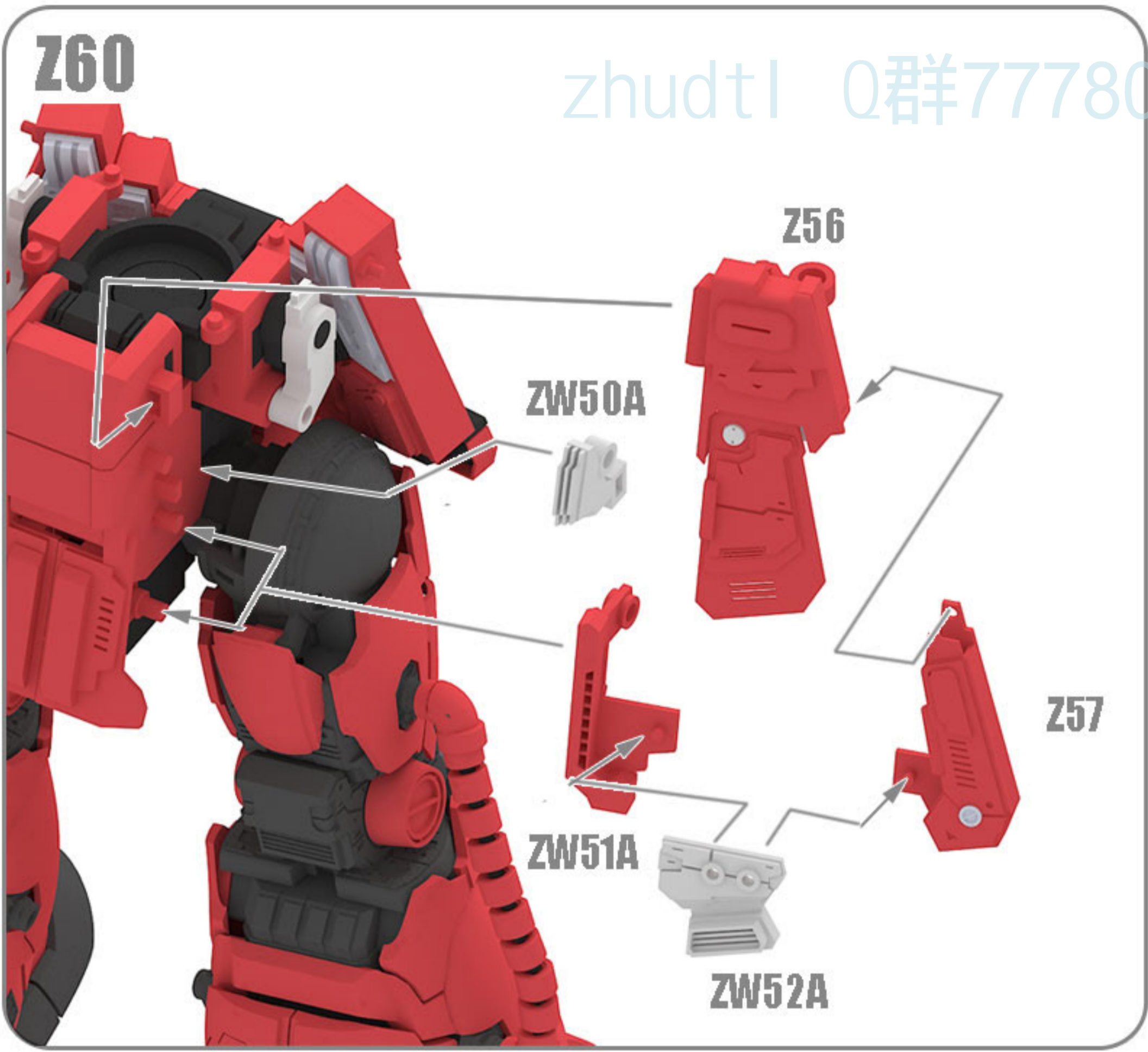

DESIGN AND CREATED BY KAIEI3D 2023

2023 年由KAIEI3D 设计与建模

PLEASE RESPECT TO THE DESIGNER EFFORT DO NOT STEAL DESIGN

请尊重设计师，切勿偷盗别人的设计

WARNING : Pirate pictures must be investigated 盗图必究

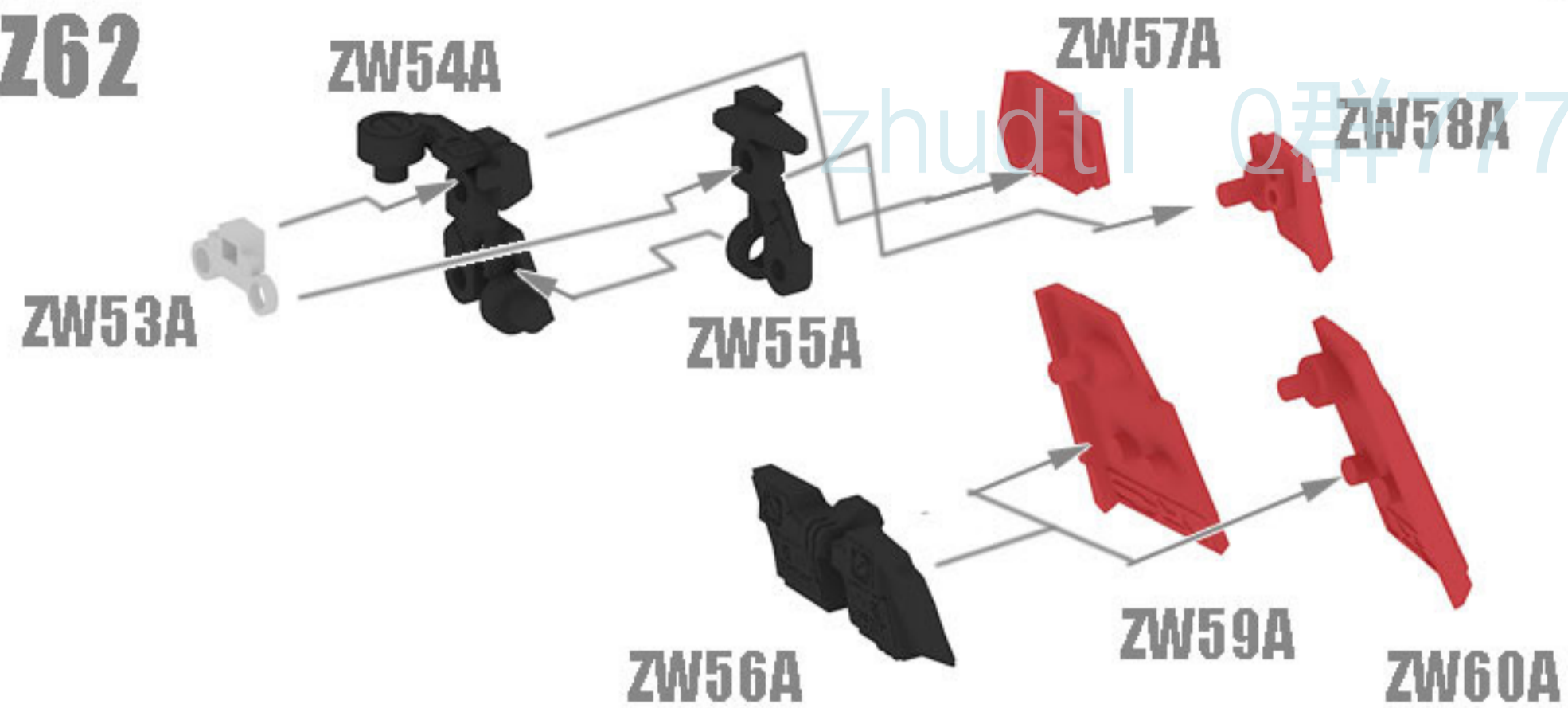
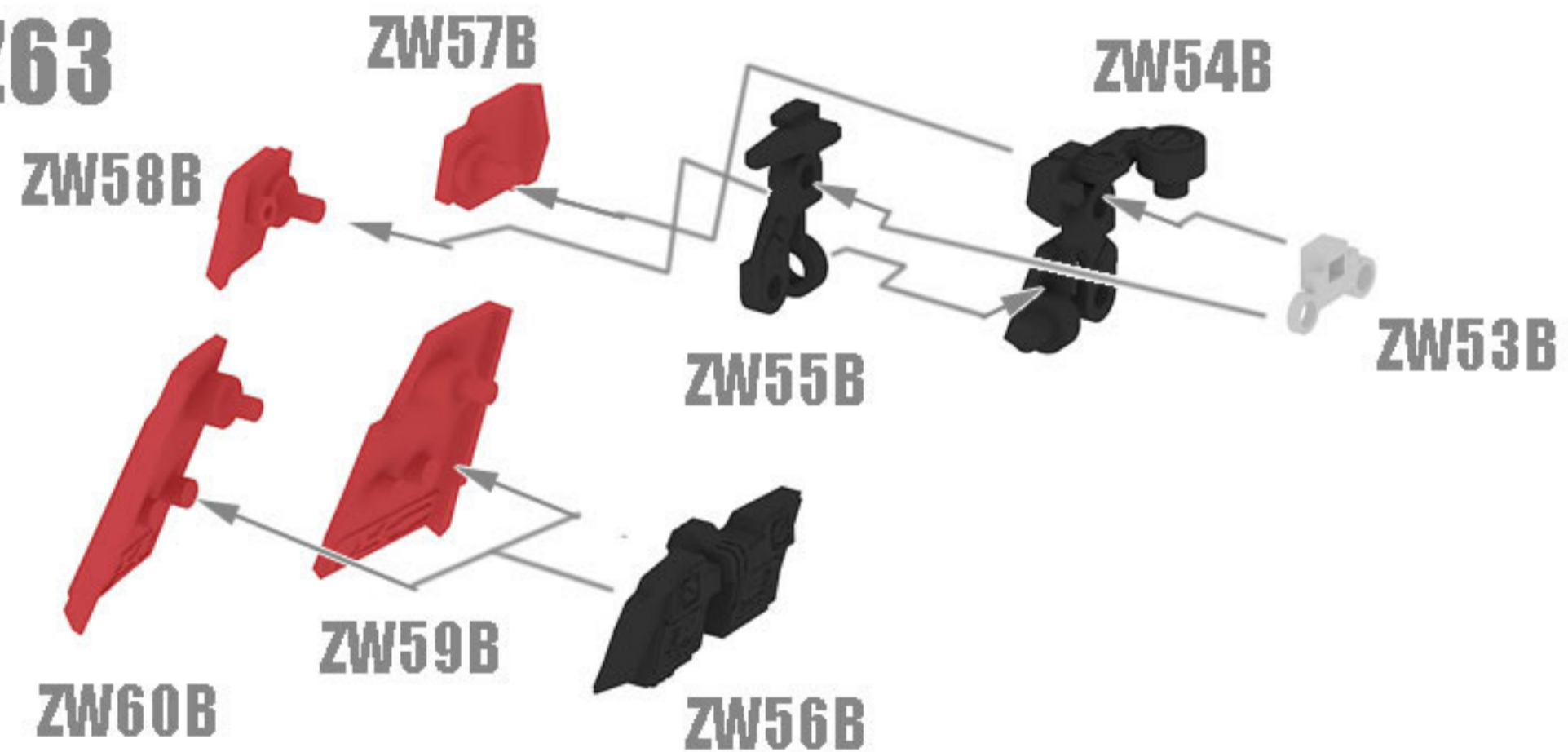
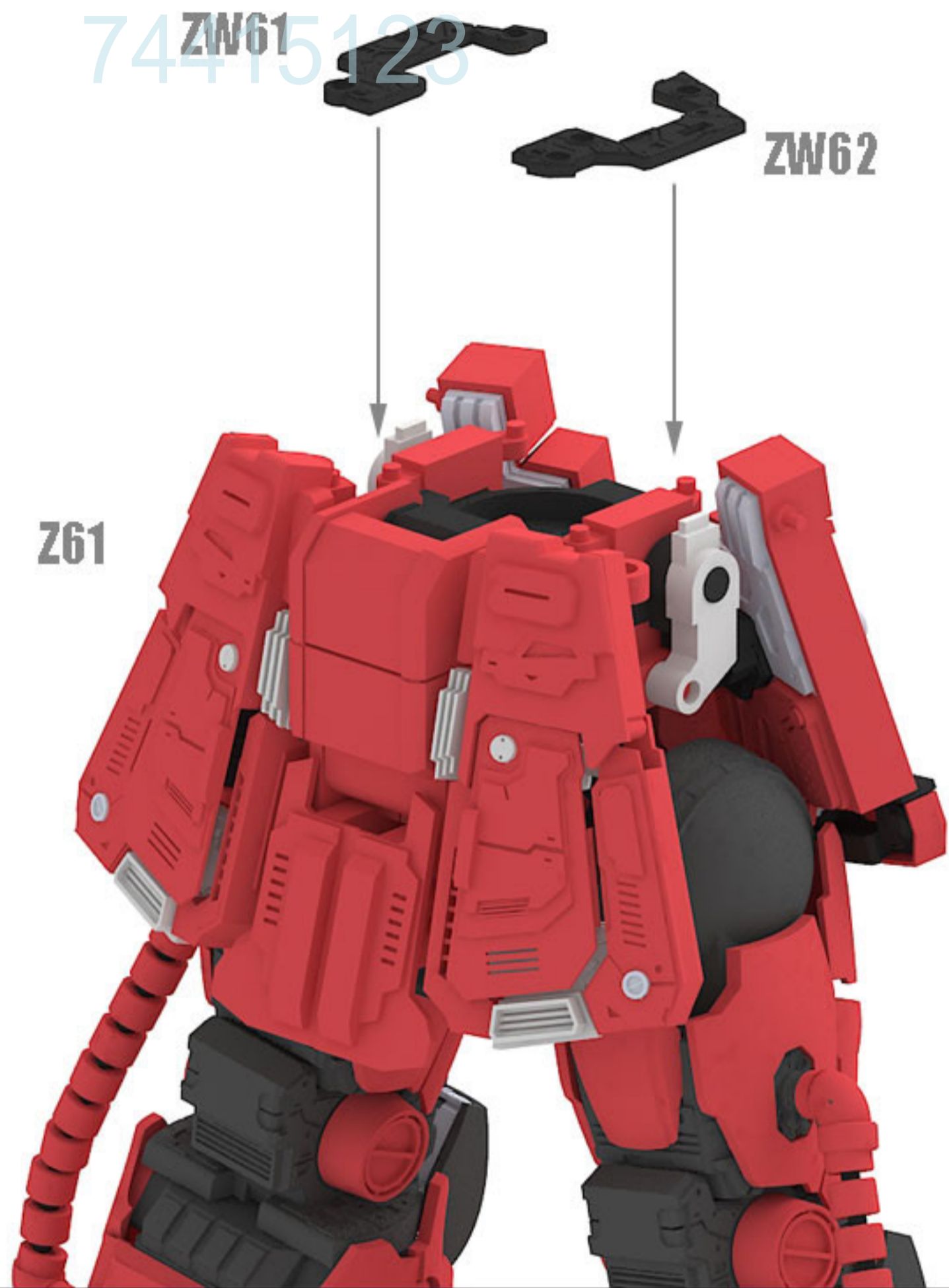

Z62**Z63****Z64**

DESIGN AND CREATED BY KAIEI3D 2023

2023 年由KAIEI3D 设计与建模

PLEASE RESPECT TO THE DESIGNER EFFORT DO NOT STEAL DESIGN

请尊重设计师，切勿偷盗别人的设计

WARNING : Pirate pictures must be investigated 盗图必究

KAIEI3D

TOYS - GADGET - HOBBY

06
MS06 ZAKU-II**3D PRINT 1:20**

Z65



Z66

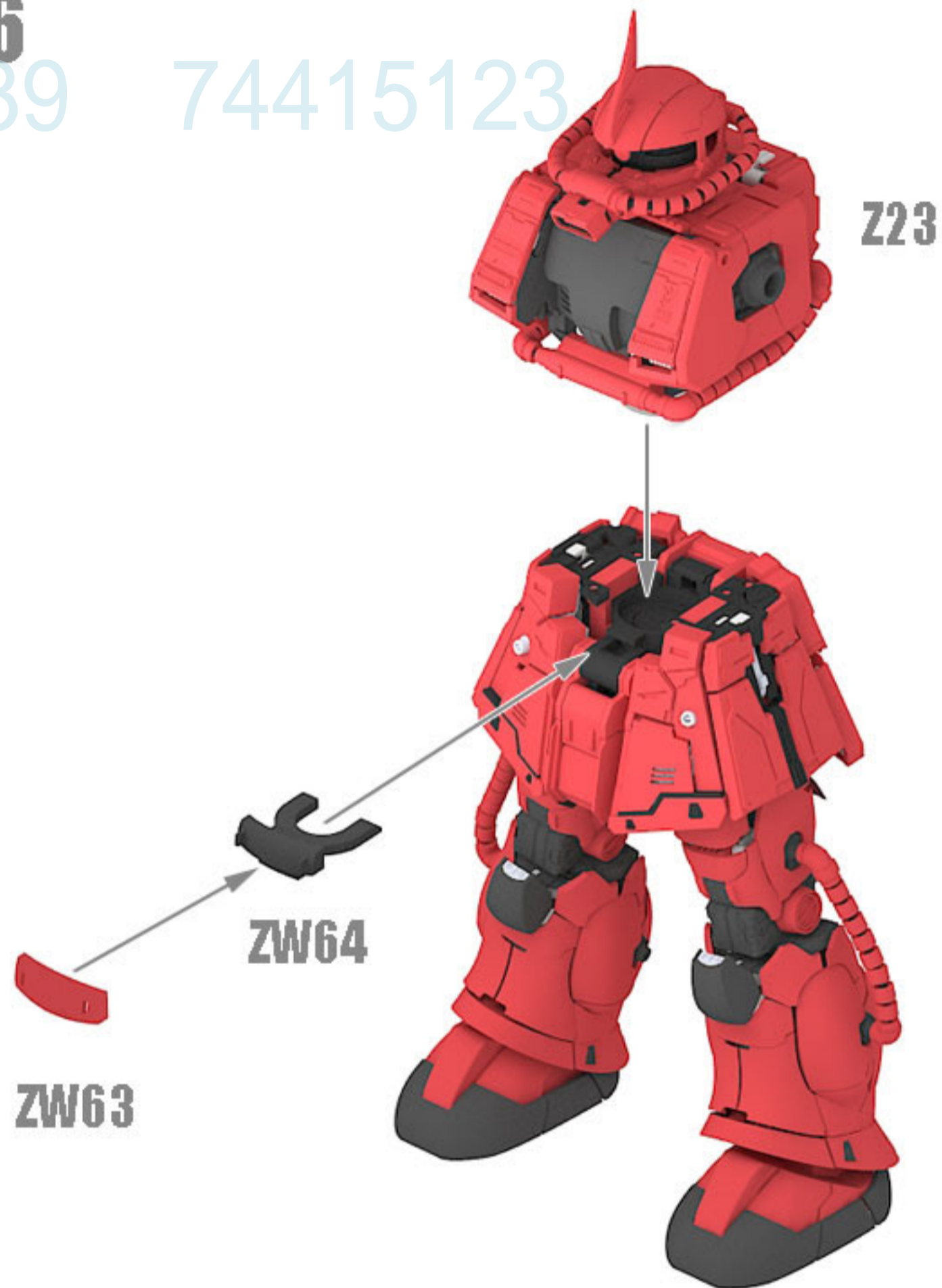

DESIGN AND CREATED BY KAIEI3D 2023

2023 年由KAIEI3D 设计与建模

PLEASE RESPECT TO THE DESIGNER EFFORT DO NOT STEAL DESIGN

请尊重设计师，切勿偷盗别人的设计

WARNING : Pirate pictures must be investigated 盗图必究

KAIEI3D

TOYS - GADGET - HOBBY

06
MS06 ZAKU-II

3D PRINT 1:20

Z66x4

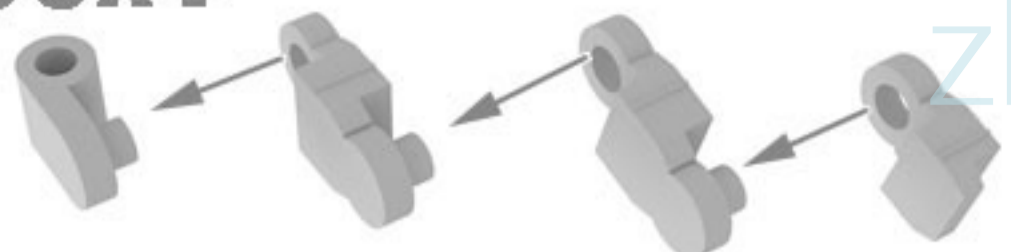

ZAL01/
ZAR01 ZAL02/
ZAR02 ZAL03/
ZAR03 ZAL04/
ZAR04

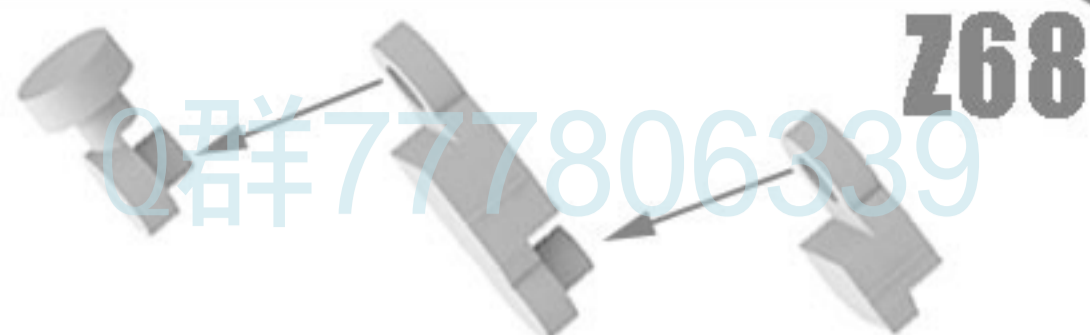

Z68

ZAL08/
ZAR08 ZAL09/
ZAR09 ZAL10/
ZAR10

Z70

ZAL15/
ZAR15



Z69

ZAL16/
ZAR16



Z67

ZAL17/
ZAR17

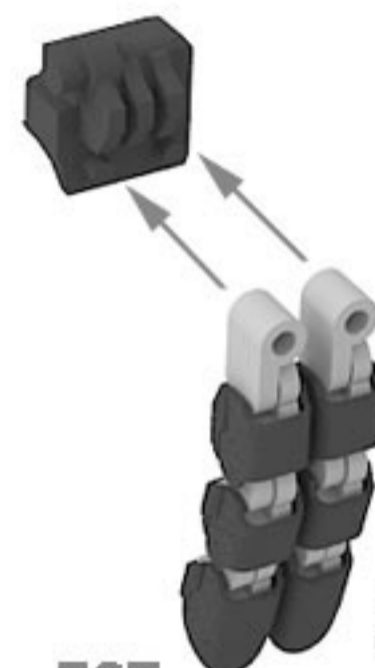

Z67

Z67

Z67

Z67x4



Z66

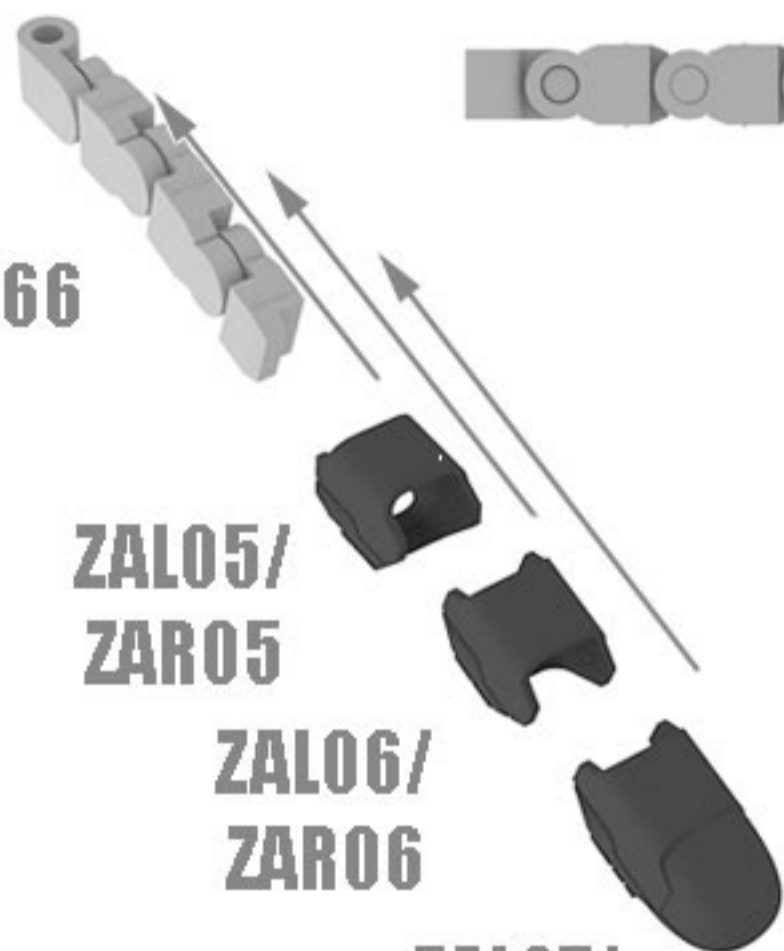

ZAL05/
ZAR05

ZAL06/
ZAR06

ZAL07/
ZAR07

Z69



ZAL11/
ZAR11

ZAL12/
ZAR12

Z68

ZAL13/
ZAR13

ZAL14/
ZAR14

DESIGN AND CREATED BY KAIEI3D 2023

2023 年由KAIEI3D 设计与建模

PLEASE RESPECT TO THE DESIGNER EFFORT DO NOT STEAL DESIGN

请尊重设计师，切勿偷盗别人的设计

WARNING : Pirate pictures must be investigated 盗图必究

KAIEI3D

TOYS · GADGET · HOBBY

06
MS06 ZAKU-II

3D PRINT 1:20

Z71**ZAL18/
ZAR18****Z70****ZAL19/
ZAR19****Z70****Z70****Z73****ZAL22/
ZAR22****ZAL23/
ZAR23****Z72****Z74****ZAL26/
ZAR26****ZAL24/
ZAR24****ZAL25/
ZAR25****Z73****ZAL27/
ZAR27****Z72****ZAL20/
ZAR20****Z71****ZAL21/
ZAR21**

DESIGN AND CREATED BY KAIEI3D 2023

2023 年由KAIEI3D 设计与建模

PLEASE RESPECT TO THE DESIGNER EFFORT DO NOT STEAL DESIGN

请尊重设计师，切勿偷盗别人的设计

WARNING : Pirate pictures must be investigated 盗图必究

KAIEI3D

TOYS - GADGET - HOBBY

06
MS06 ZAKU-II**3D PRINT 1:20**

Z75

ZAL28/
ZAR28

ZAL31/
ZAR31

ZAL32/
ZAR32

ZAL33/
ZAR33

ZAL29/
ZAR29

ZAL30/
ZAR30

ZAL34/
ZAR34

Z74

Z76

ZAL35/
ZAR35

ZAL37/
ZAR37

ZAL36/
ZAR36

ZAL39/
ZAR39

ZAL41/
ZAR41

ZAL40/
ZAR40

ZAL38/
ZAR38

Z75

Z77

ZAL42/
ZAR42

ZAL43/
ZAR43

ZAL44/
ZAR44

ZAL45/
ZAR45

Z76

DESIGN AND CREATED BY KAIEI3D 2023

2023 年由KAIEI3D 设计与建模

PLEASE RESPECT TO THE DESIGNER EFFORT DO NOT STEAL DESIGN

请尊重设计师，切勿偷盗别人的设计

WARNING : Pirate pictures must be investigated 盗图必究



TOYS - GADGET - HOBBY



MS06 ZAKU-II

3D PRINT 1:20

Z78

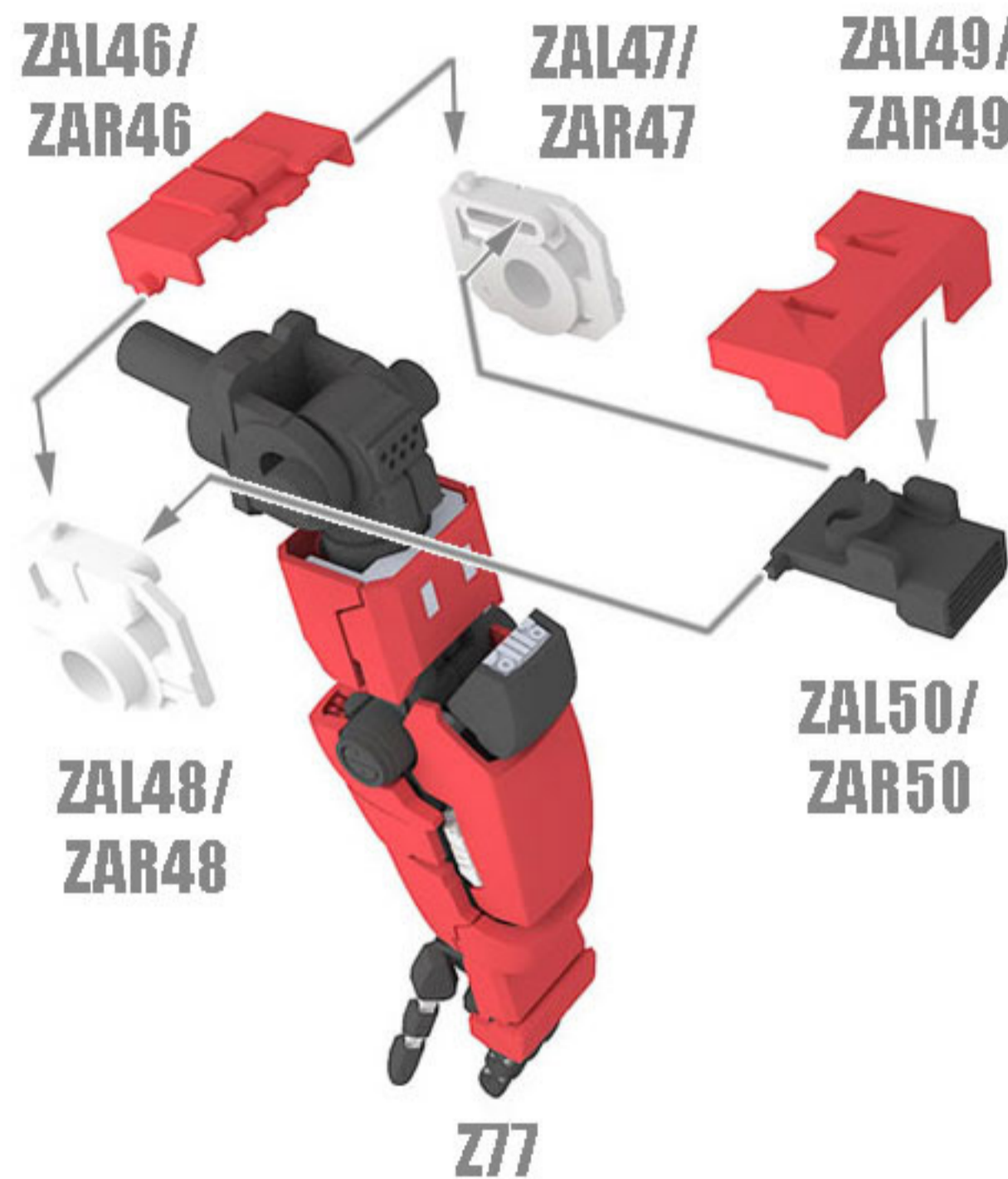

zhudtl Q群#777806339 74415123

Z79



DESIGN AND CREATED BY KAIEI3D 2023

2023 年由KAIEI3D 设计与建模

PLEASE RESPECT TO THE DESIGNER EFFORT DO NOT STEAL DESIGN

请尊重设计师，切勿偷盗别人的设计

WARNING : Pirate pictures must be investigated 盗图必究



Z80

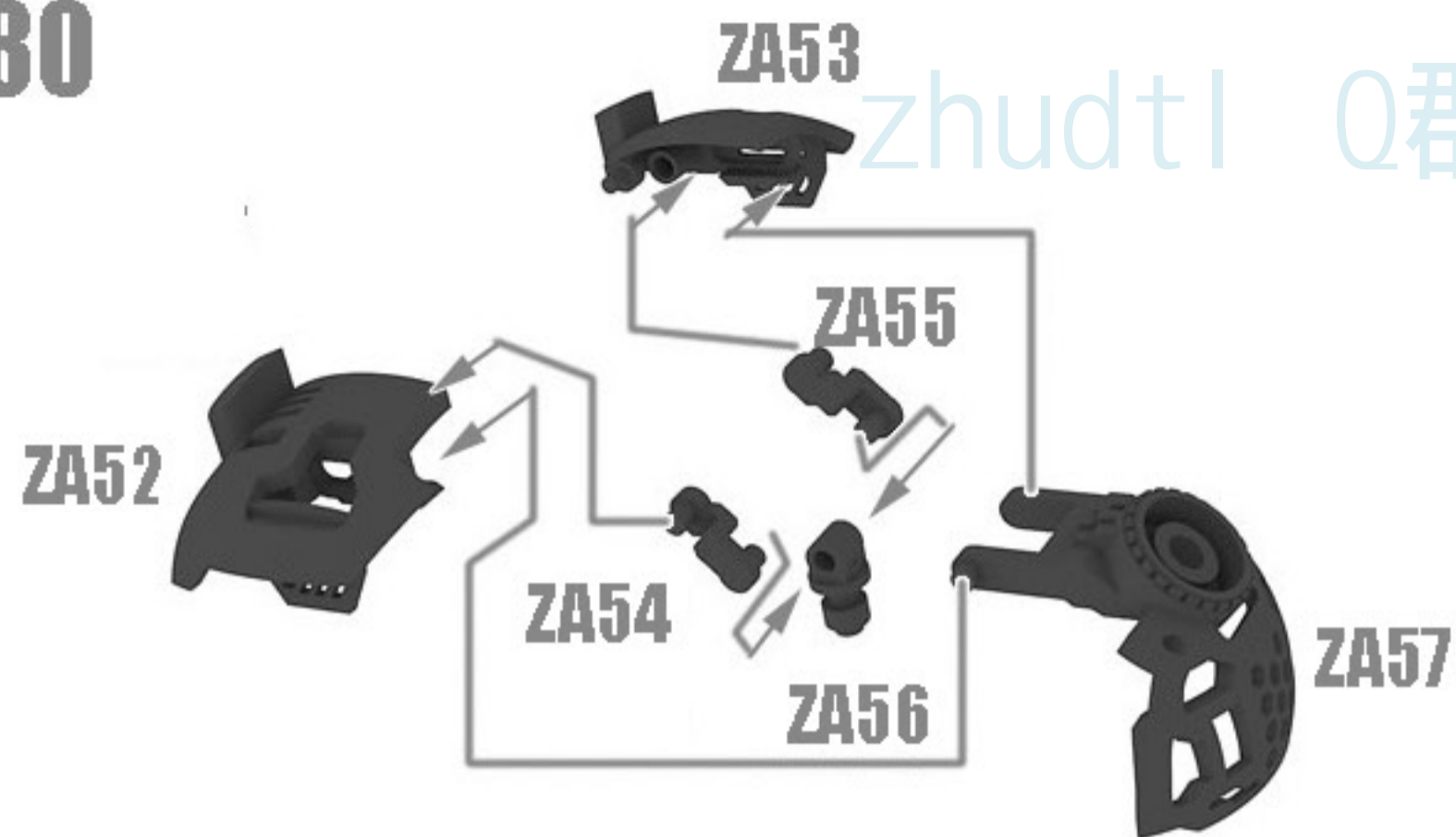

Z82

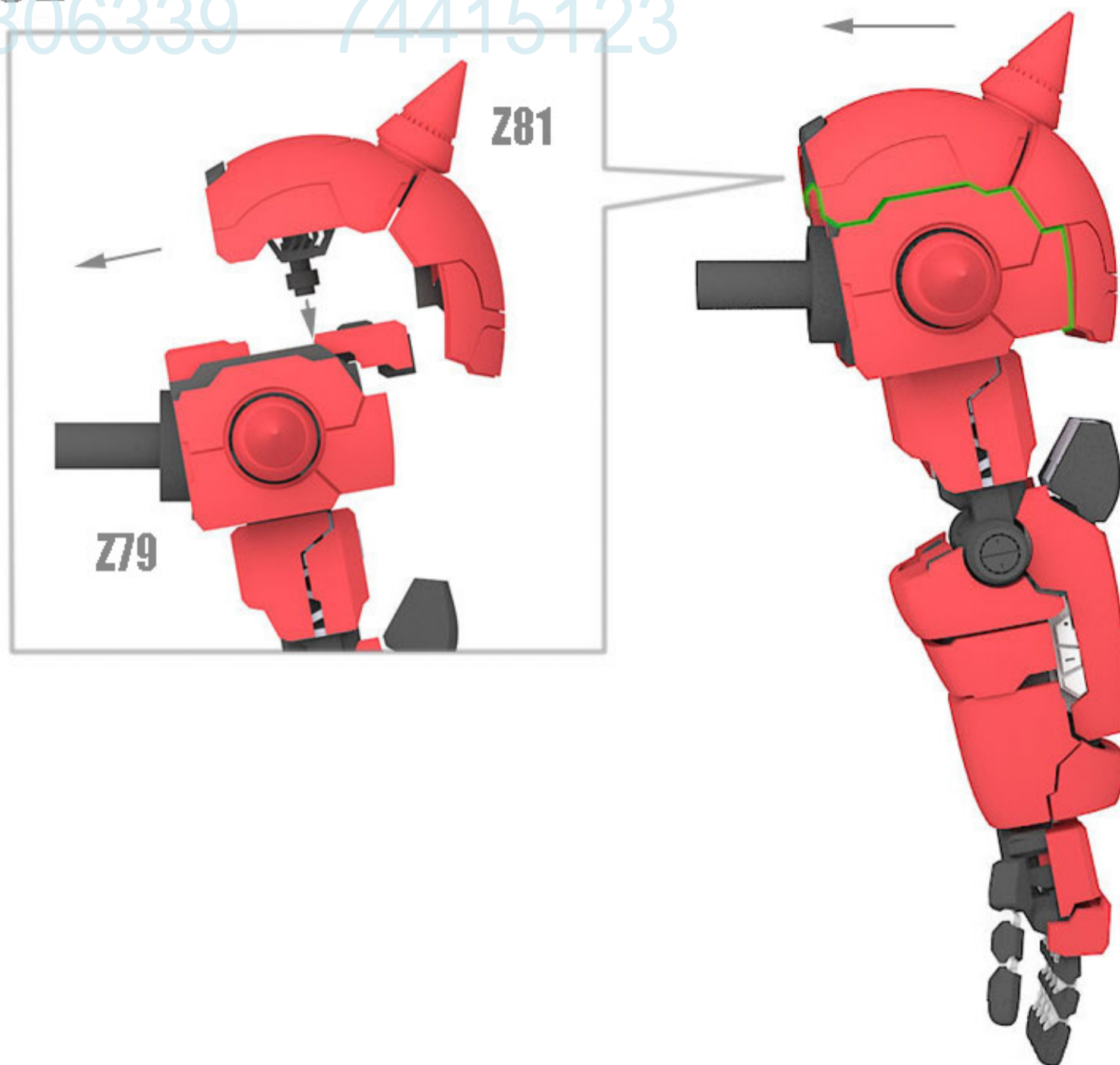

Z81



DESIGN AND CREATED BY KAIEI3D 2023

2023 年由KAIEI3D 设计与建模

PLEASE RESPECT TO THE DESIGNER EFFORT DO NOT STEAL DESIGN

请尊重设计师，切勿偷盗别人的设计

WARNING : Pirate pictures must be investigated 盗图必究



TOYS · GADGET · HOBBY



3D PRINT 1:20

Z83



ZA61A



ZA61B

zhudt | Q群777806339 | 74415123

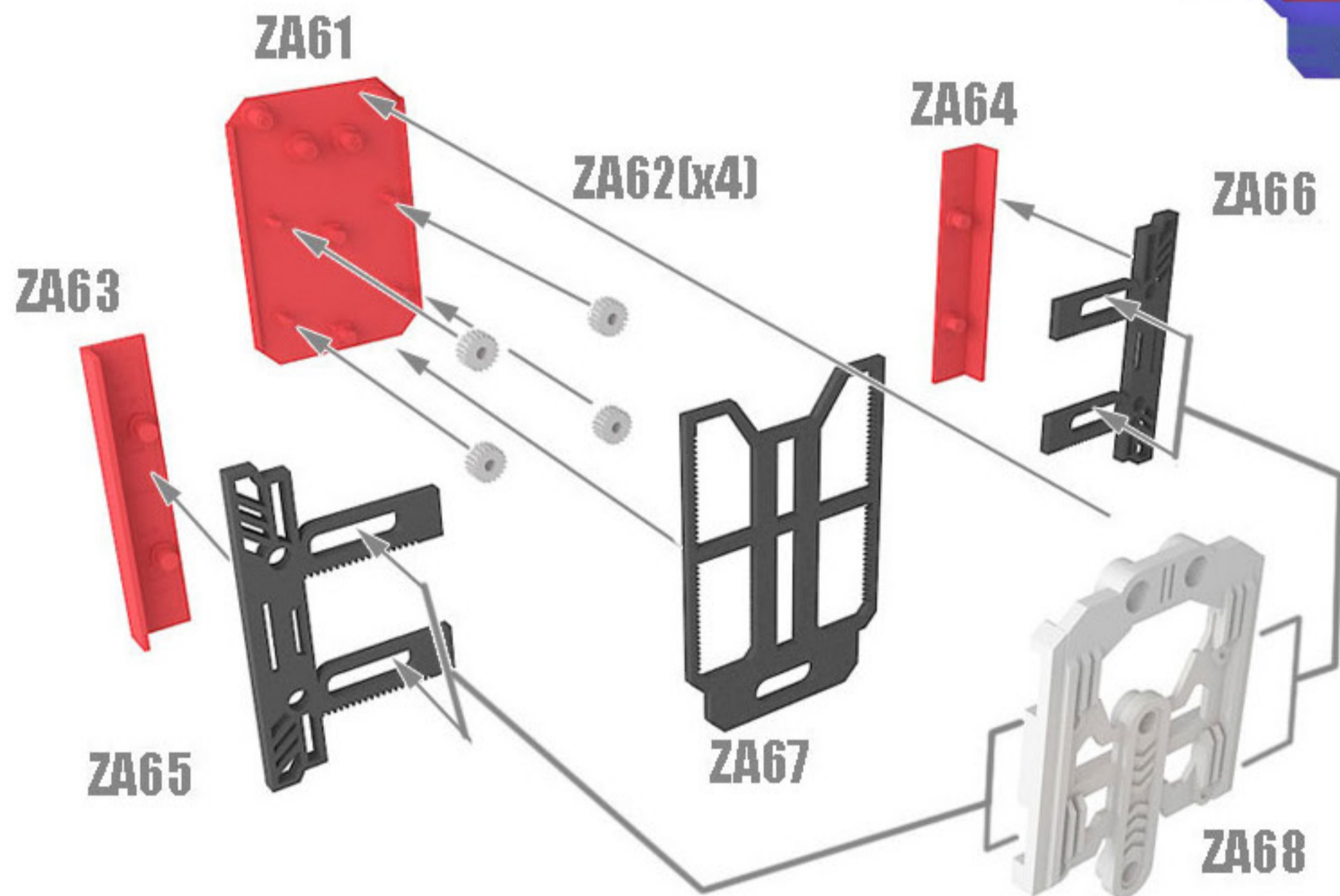
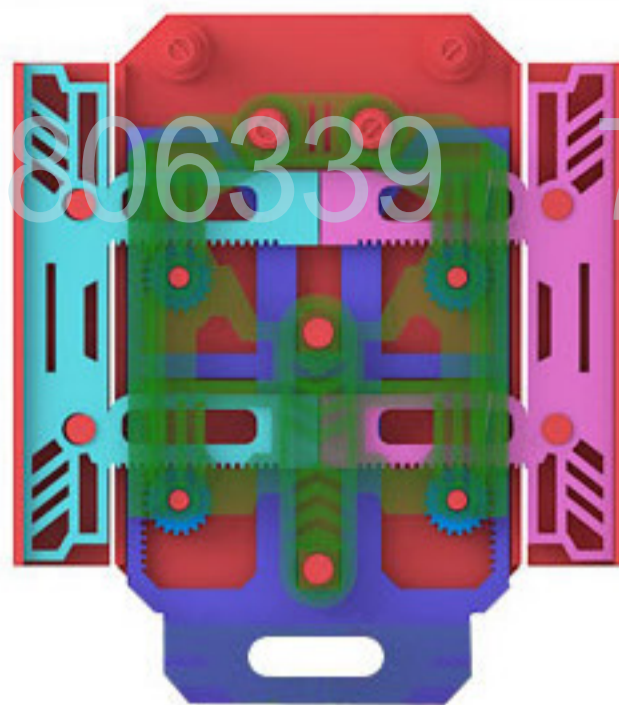

Z84

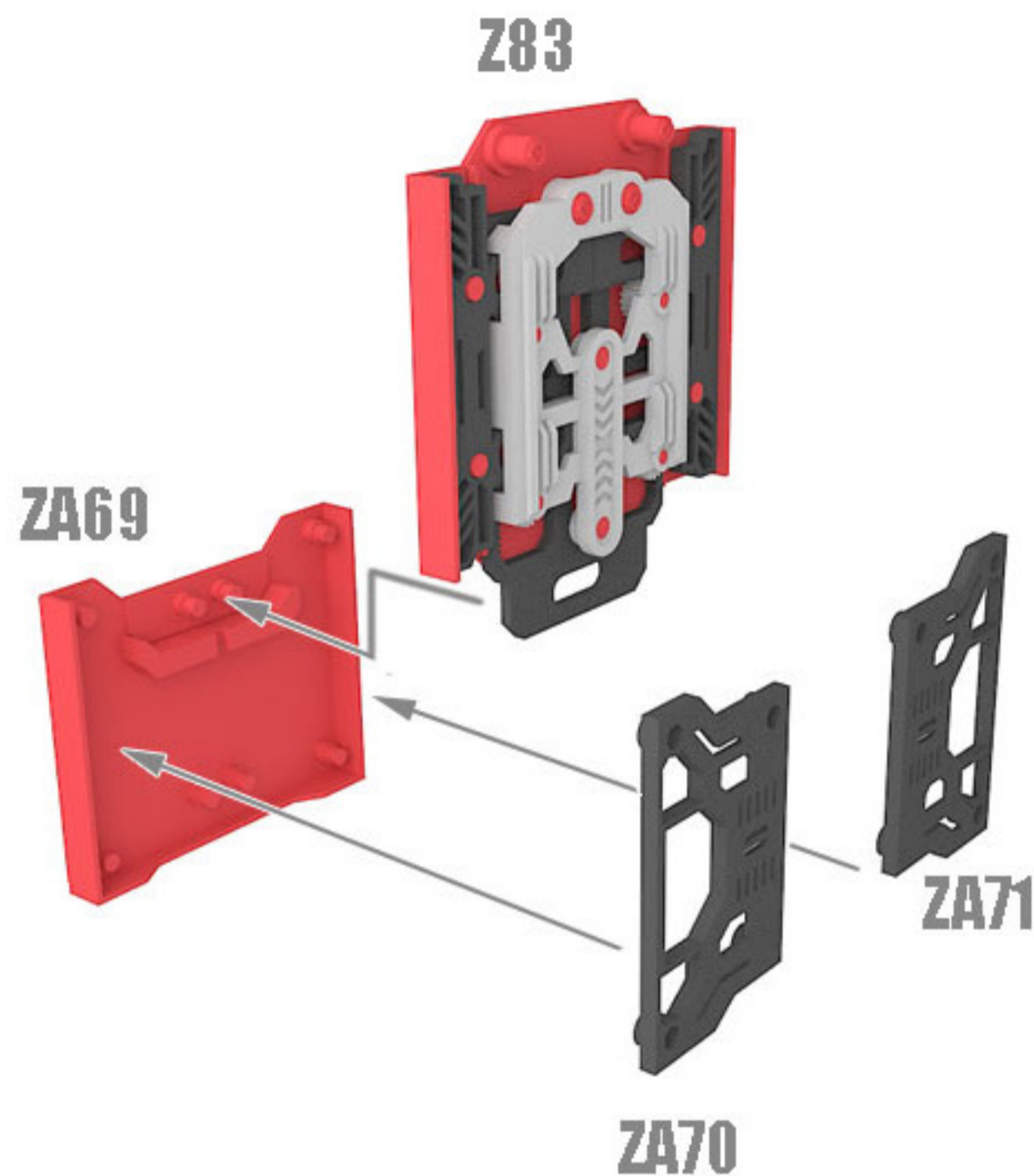

DESIGN AND CREATED BY KAIEI3D 2023

2023 年由KAIEI3D 设计与建模

PLEASE RESPECT TO THE DESIGNER EFFORT DO NOT STEAL DESIGN

请尊重设计师，切勿偷盗别人的设计

WARNING : Pirate pictures must be investigated 盗图必究



TOYS · GADGET · HOBBY



3D PRINT 1:20

Z85

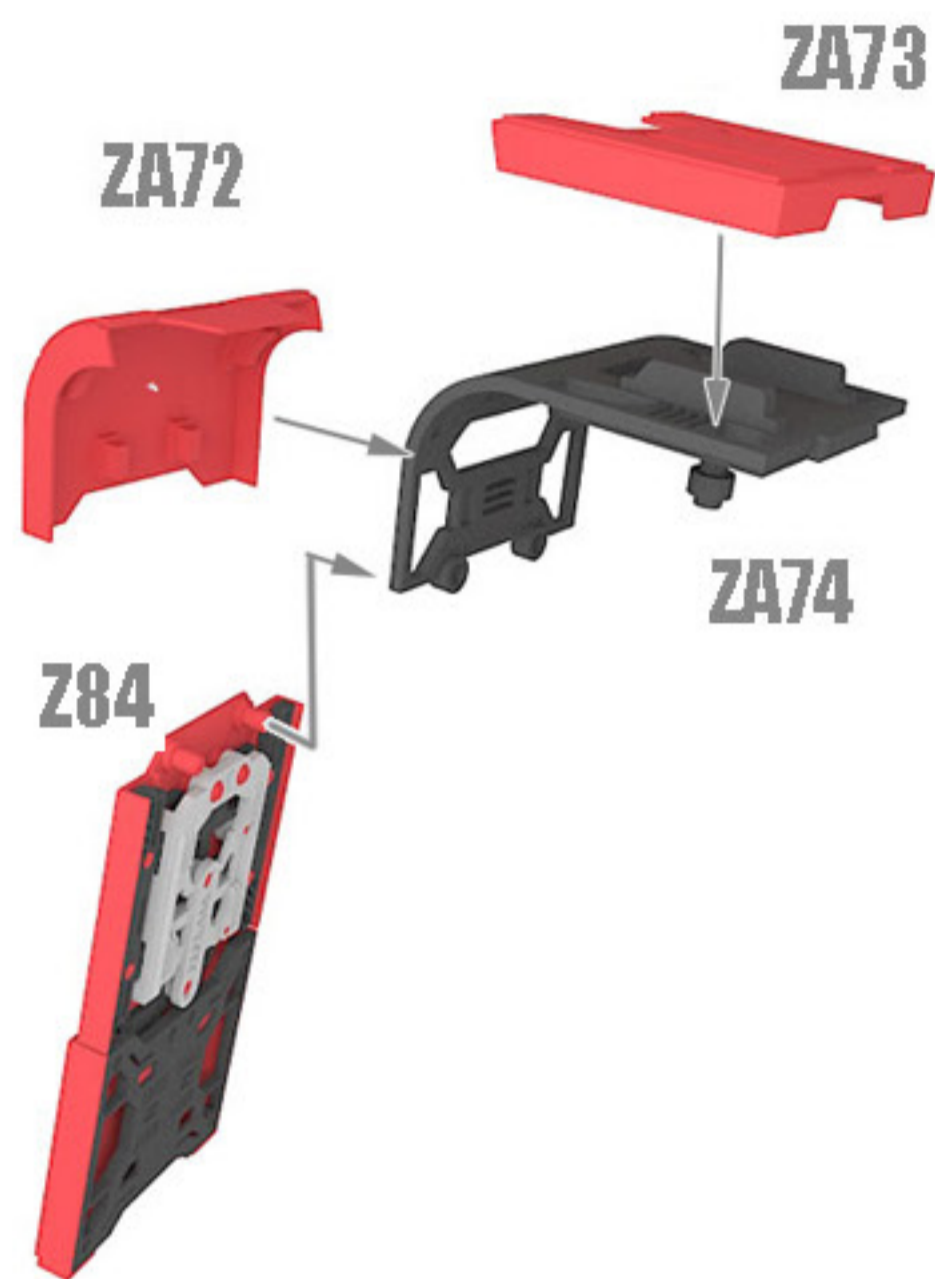

Z86

zhudt | Q群777806339 | 74415123

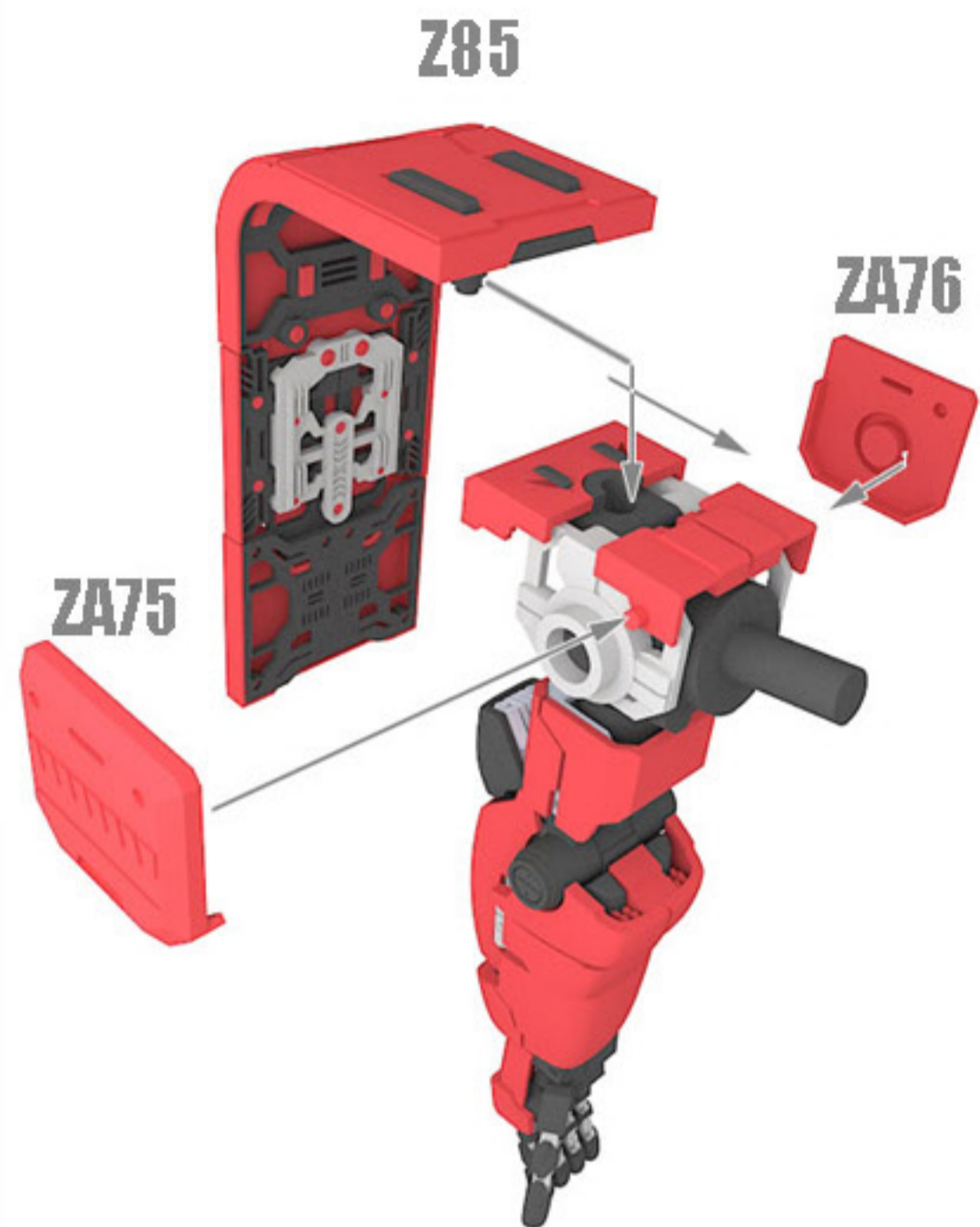

Z87

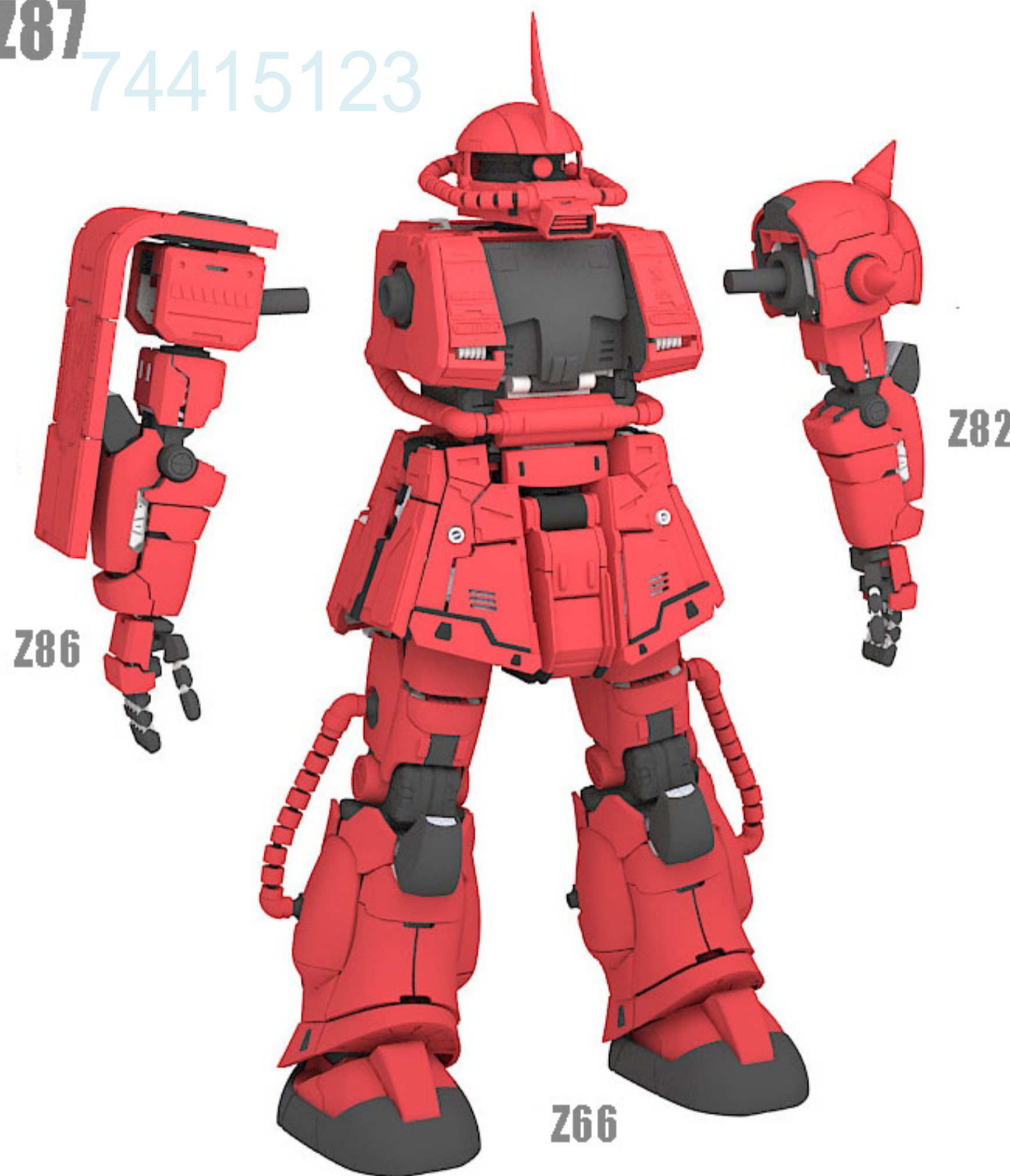

DESIGN AND CREATED BY KAIEI3D 2023

2023 年由KAIEI3D 设计与建模

PLEASE RESPECT TO THE DESIGNER EFFORT DO NOT STEAL DESIGN

请尊重设计师，切勿偷盗别人的设计

WARNING : Pirate pictures must be investigated 盗图必究

KAIEI3D

TOYS · GADGET · HOBBY

06
MS06 ZAKU-II

3D PRINT 1:20

COMPLETE

zhudt | Q群777806339 74415123



FRONT

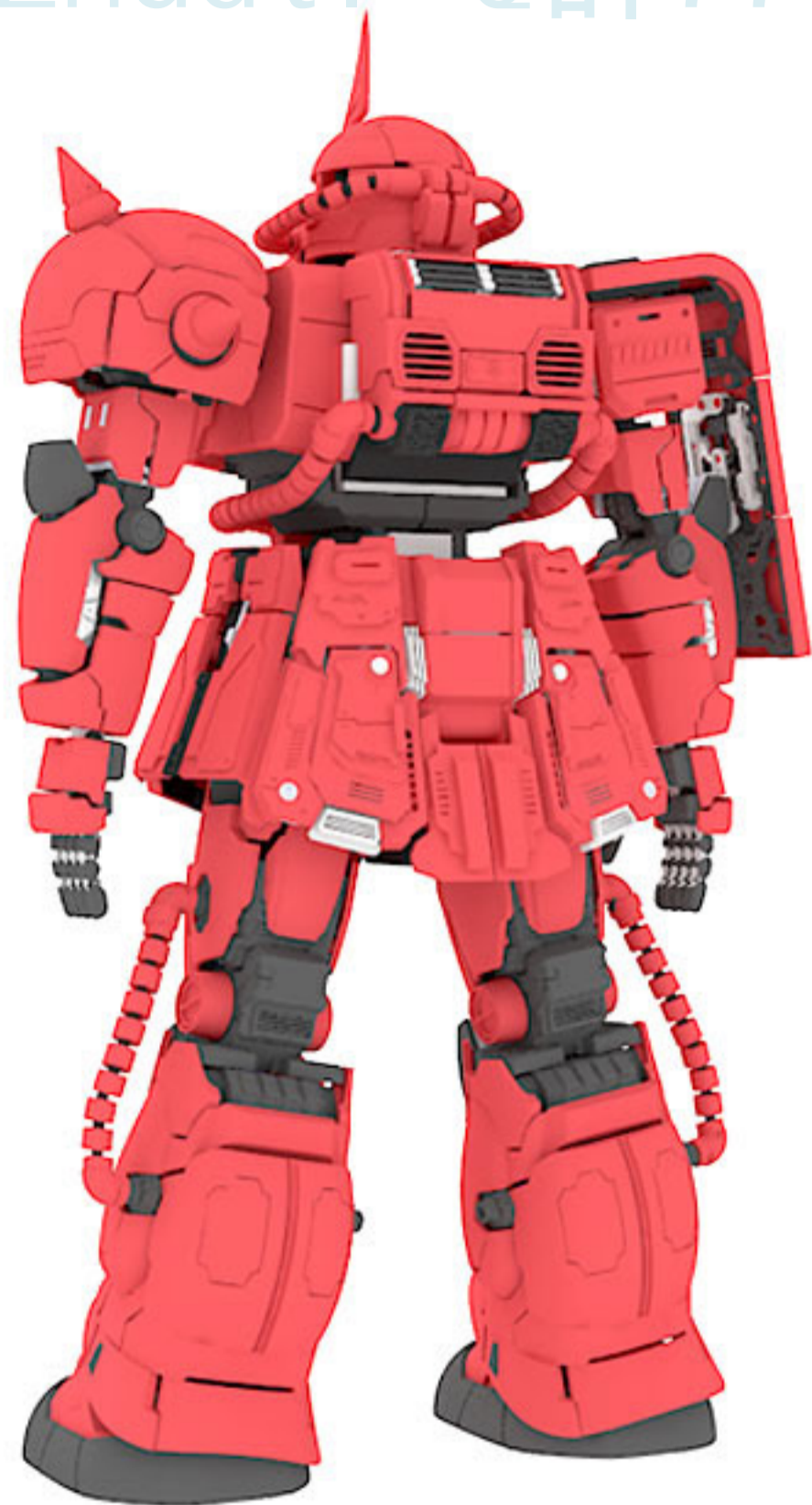

BACK



OPEN HATCH



DESIGN AND CREATED BY KAIEI3D 2023

2023 年由KAIEI3D 设计与建模

PLEASE RESPECT TO THE DESIGNER EFFORT DO NOT STEAL DESIGN

请尊重设计师，切勿偷盗别人的设计

WARNING : Pirate pictures must be investigated 盗图必究

KAIEI3D

TOYS - GADGET - HOBBY

06
MS06 ZAKU-II

3D PRINT 1:20

zhudt | Q群777806339 74415123



MS06



MS06S



BLANK SHOULDER



BOTH SHIELD



BOTH SPIKE

DESIGN AND CREATED BY KAIEI3D 2023

2023 年由KAIEI3D 设计与建模

PLEASE RESPECT TO THE DESIGNER EFFORT DO NOT STEAL DESIGN

请尊重设计师，切勿偷盗别人的设计

WARNING : Pirate pictures must be investigated 盗图必究



TOYS · GADGET · HOBBY



3D PRINT 1:20

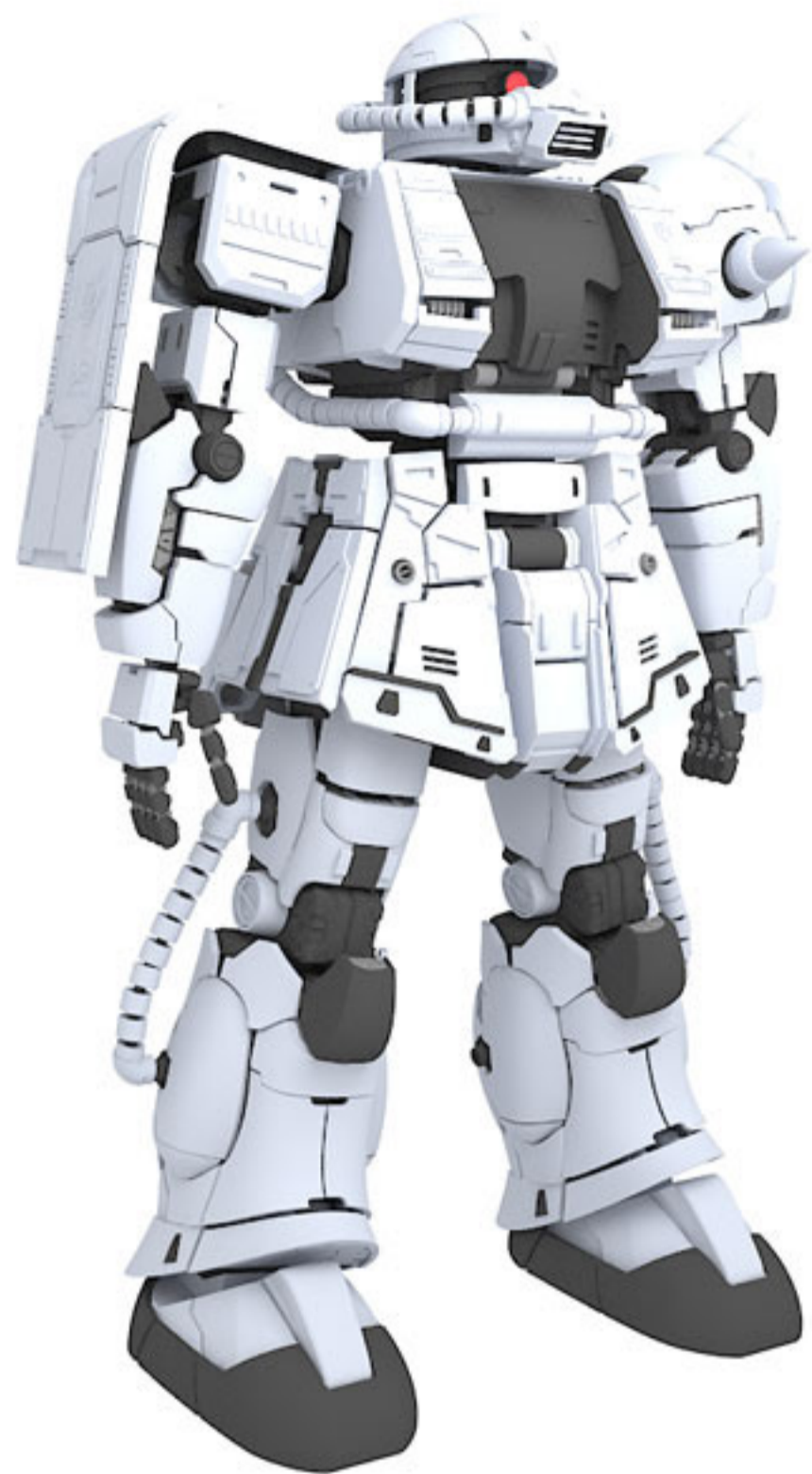

ZA61C



BD28R C



BD07 C

EXTRA TIPS*

print with different color filament combination to create different Zaku unit

SPECIAL NOTE:

when 3D print 1/20 Zaku II finale youtube video reach above 1000 likes, we will update new parts for this 3D print 1/20 Zaku II. For those who already purchased can enjoy the update part for free. Share and like the video, more "likes" will make more upgrade part will release. Thanks



DESIGN AND CREATED BY KAIEI3D 2023
2023 年由KAIEI3D 设计与建模
PLEASE RESPECT TO THE DESIGNER EFFORT DO NOT STEAL DESIGN
请尊重设计师，切勿偷盗别人的设计
WARNING : Pirate pictures must be investigated 盗图必究

