

zhudtl Q群777806339 74415123

1/20 ZAKU II BUST

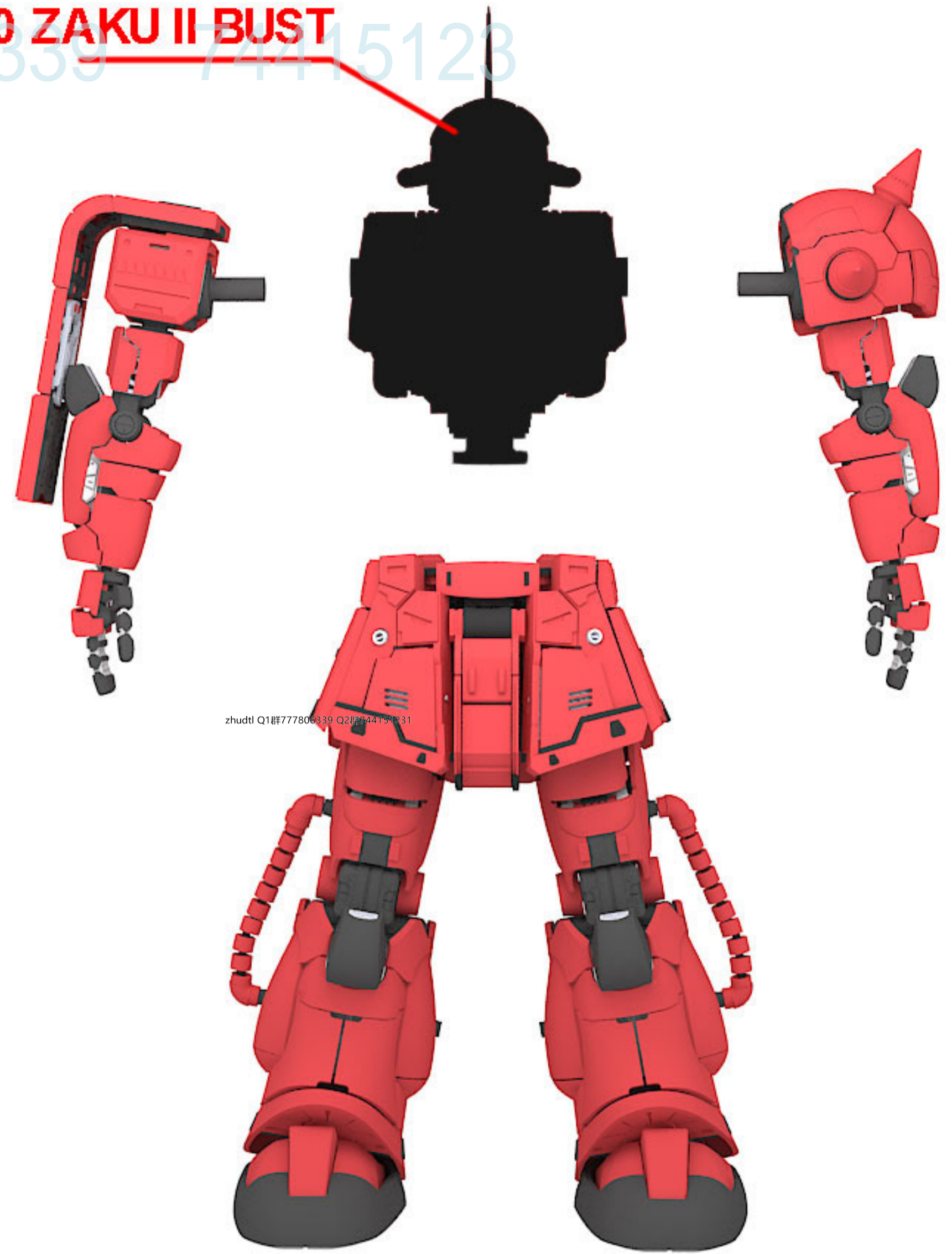

06 3D PRINT 1:20

BUST ADD-ON Ver.

MS06 ZAKU-II

DESIGN AND CREATED BY KAIEI3D 2023

2023 年由KAIEI3D 设计与建模

PLEASE RESPECT TO THE DESIGNER EFFORT DO NOT STEAL DESIGN

请尊重设计师，切勿偷盗别人的设计

WARNING : Pirate pictures must be investigated 盗图必究

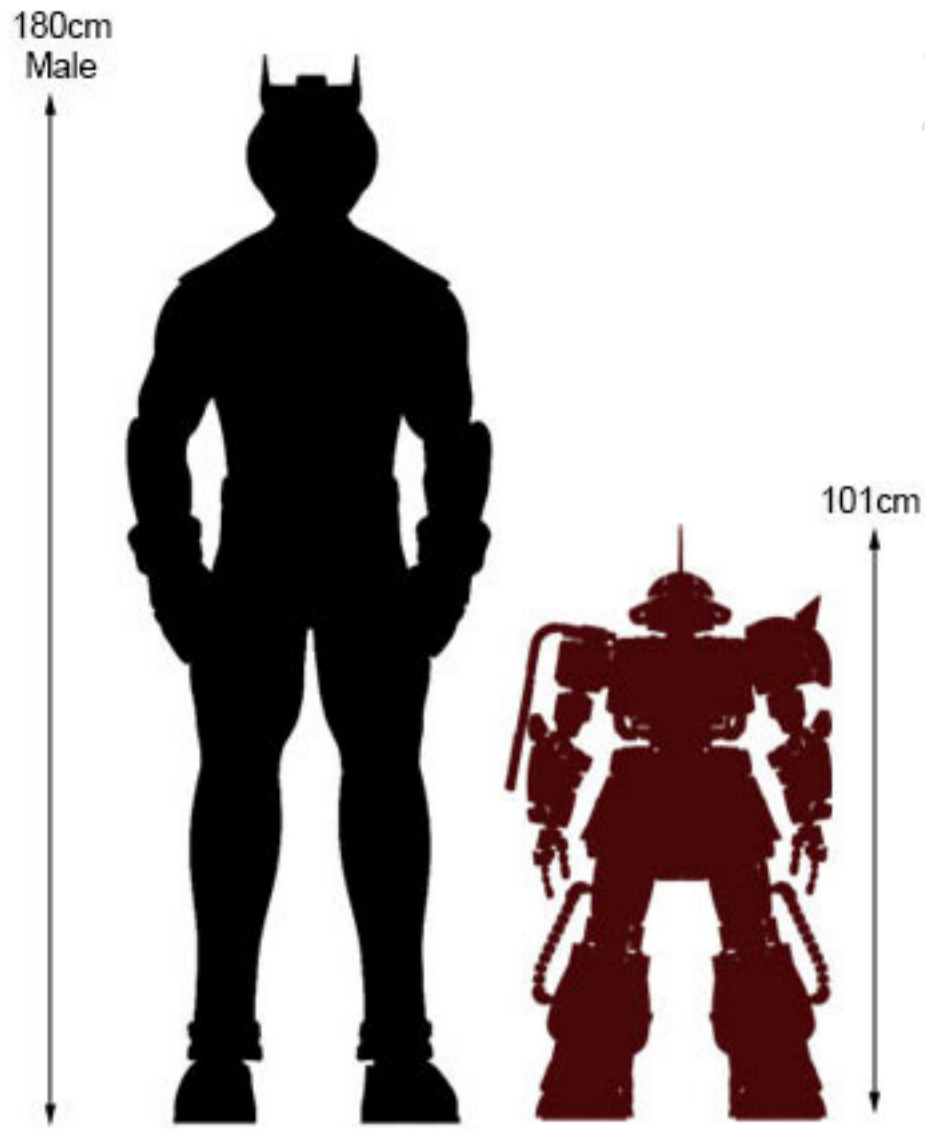

3D PRINT 1/20 ZAKU II
692 parts / 13.7kg / 857 hours

PART INCLUDED IN THE PACKAGE

1/20 3D Print Zaku II PART 4 : WAIST

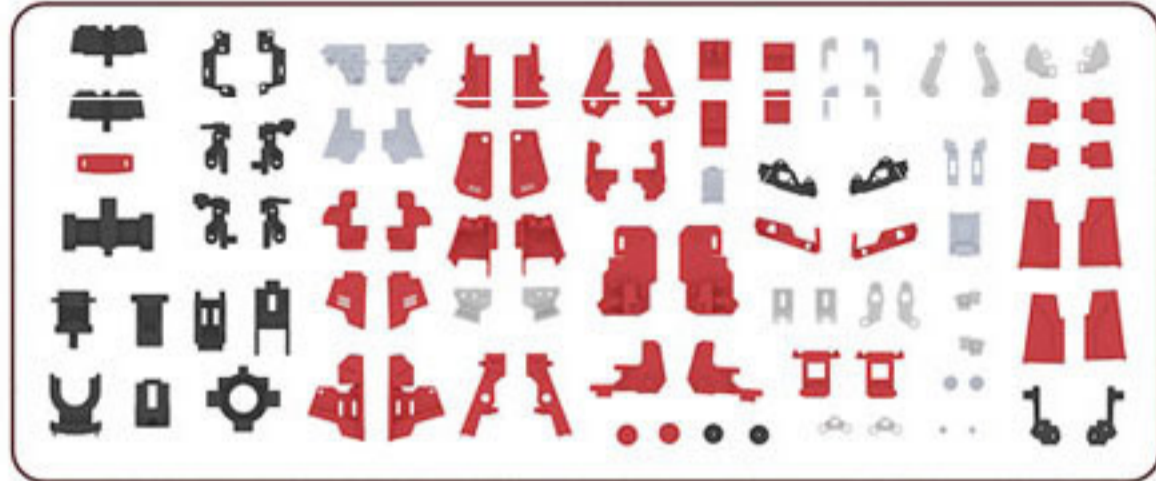

94 parts / 3000g PLA / 100hours

1/20 3D Print Zaku II PART 5 : LEGS

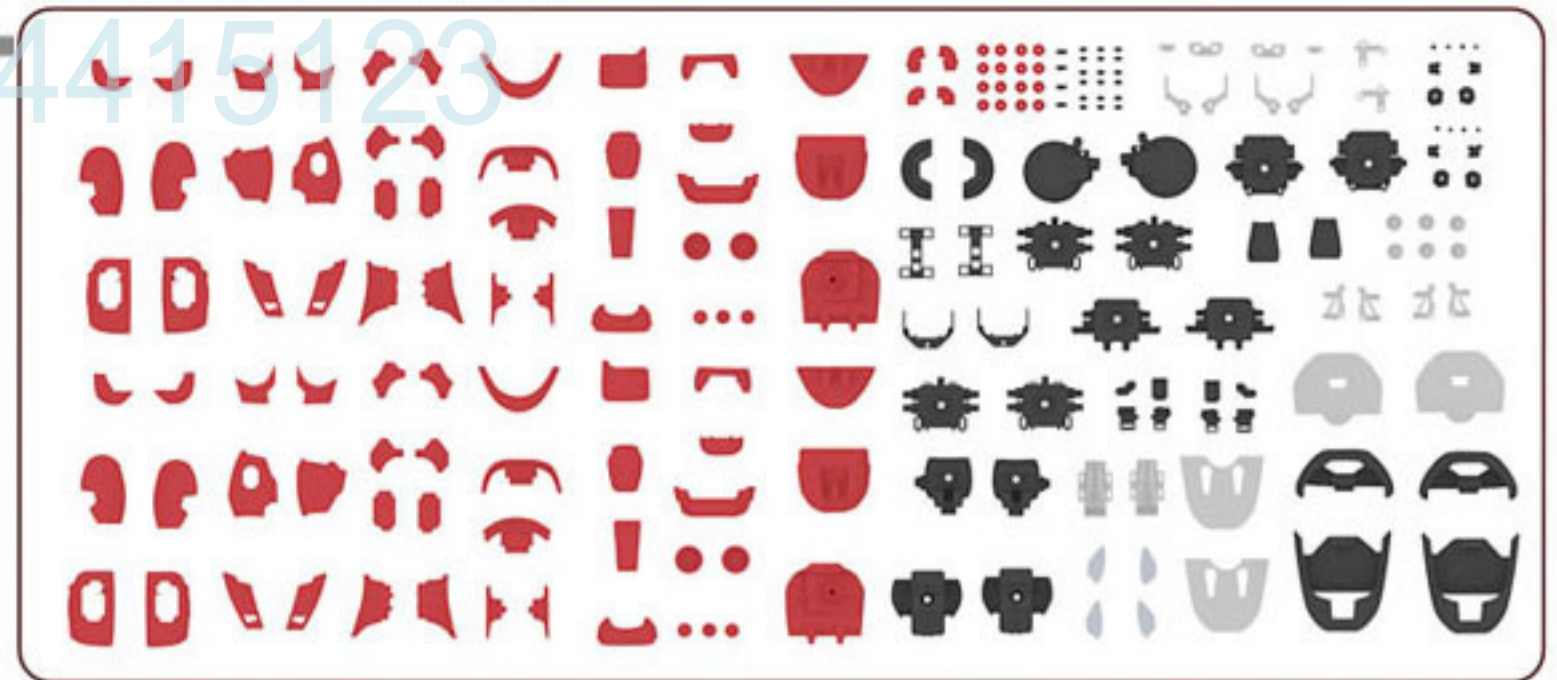

203 parts / 4400g PLA / 335hours

1/20 3D Print Zaku II PART FINALE : ARMS

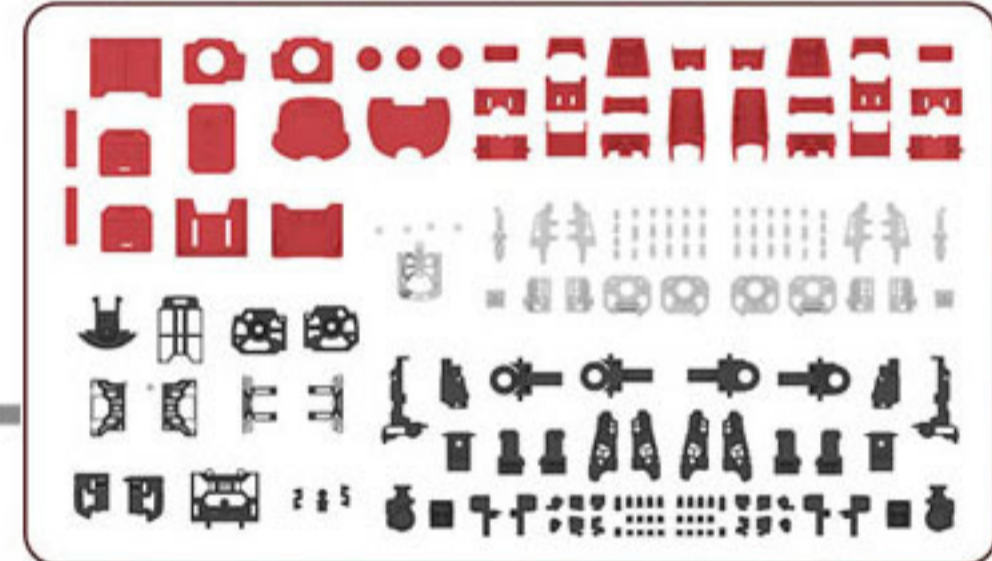

180 parts / 2700g PLA / 155hours

NOTICE



3D printer with
build volume
180mm x 180mm
x180mm above



Cutter & filler
or sanding
tools



Super Glue***part thats
not involve to articlacion
are advise to glue it if
too loose**



Etimate ready
14KG above
filament



YouTube

DESIGN AND CREATED BY KAIEI3D 2023

2023 年由KAIEI3D 设计与建模

PLEASE RESPECT TO THE DESIGNER EFFORT DO NOT STEAL DESIGN

请尊重设计师，切勿偷盗别人的设计

WARNING : Pirate pictures must be investigated 盗图必究



TOYS - GADGET - HOBBY



3D PRINT 1:20

BUST COMPLETE ADD-ON EDITION

BUST ADD-ON Ver.

1/20 ZAKU II BUST

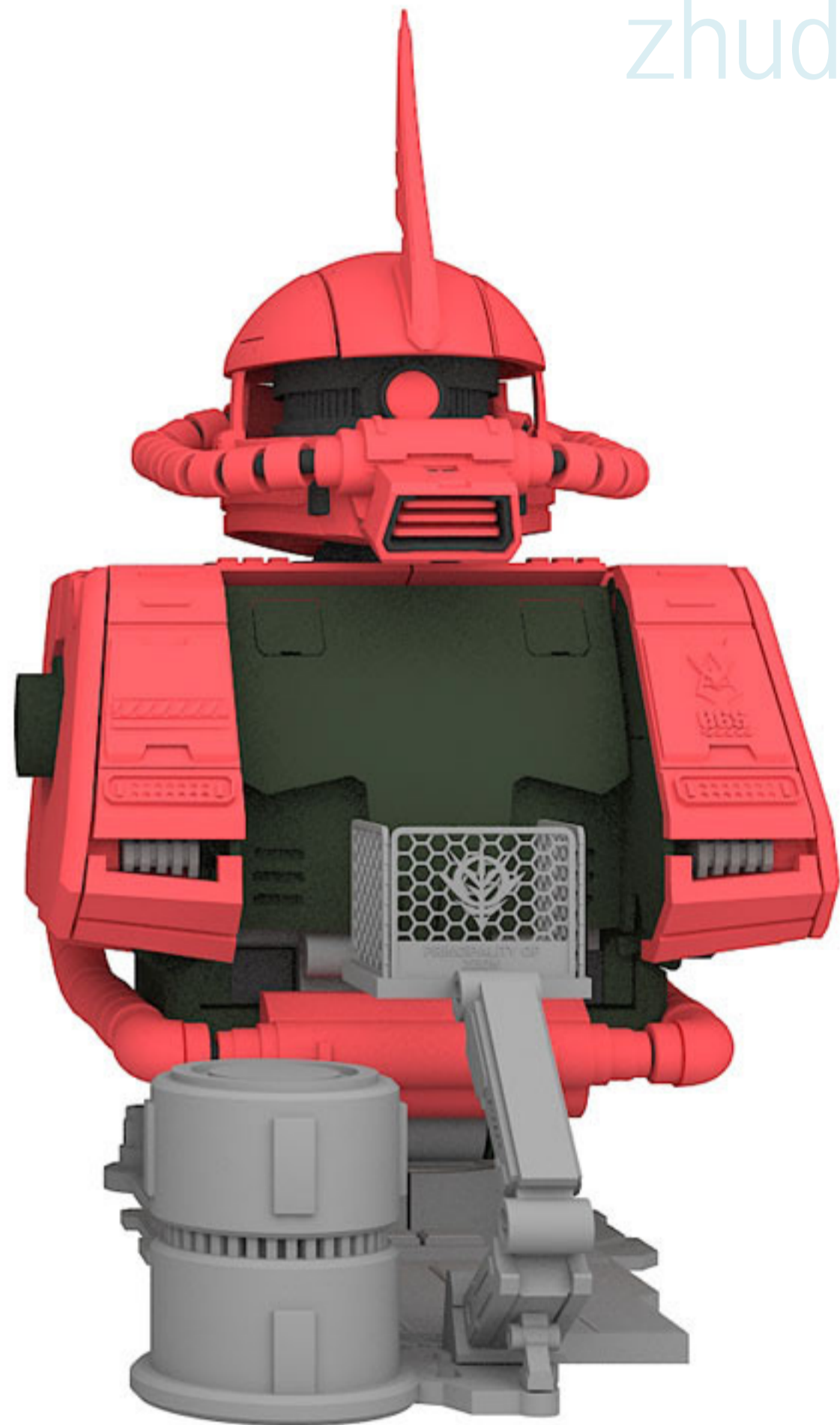

zhudti Q群#777806339 74415123

Z24

ZLL05/
ZLR05

ZLL03/
ZLR03

ZLL01/
ZLR01

ZLL02/
ZLR02

ZLL12/
ZLR12

ZLL14/
ZLR14

ZLL07/
ZLR07

ZLL06/
ZLR06

ZLL04/
ZLR04

ZLL10/
ZLR10

ZLL15/
ZLR15

ZLL13/
ZLR13

Z25

ZLL08/
ZLR08

ZLL09/
ZLR09

ZLL11/
ZLR11

DESIGN AND CREATED BY KAIEI3D 2023

2023 年由KAIEI3D 设计与建模

PLEASE RESPECT TO THE DESIGNER EFFORT DO NOT STEAL DESIGN

请尊重设计师，切勿偷盗别人的设计

WARNING : Pirate pictures must be investigated 盗图必究



TOYS · GADGET · HOBBY



3D PRINT 1:20

BUST ADD-ON Ver.

Z26

Stainless Steel Shaft Rod
øDiameter 6mm 400mm long

* this is part need to prepare by your own, It can be found in at most of the hardware store

* can replace with same size PVC pipe or wood stick



Z27

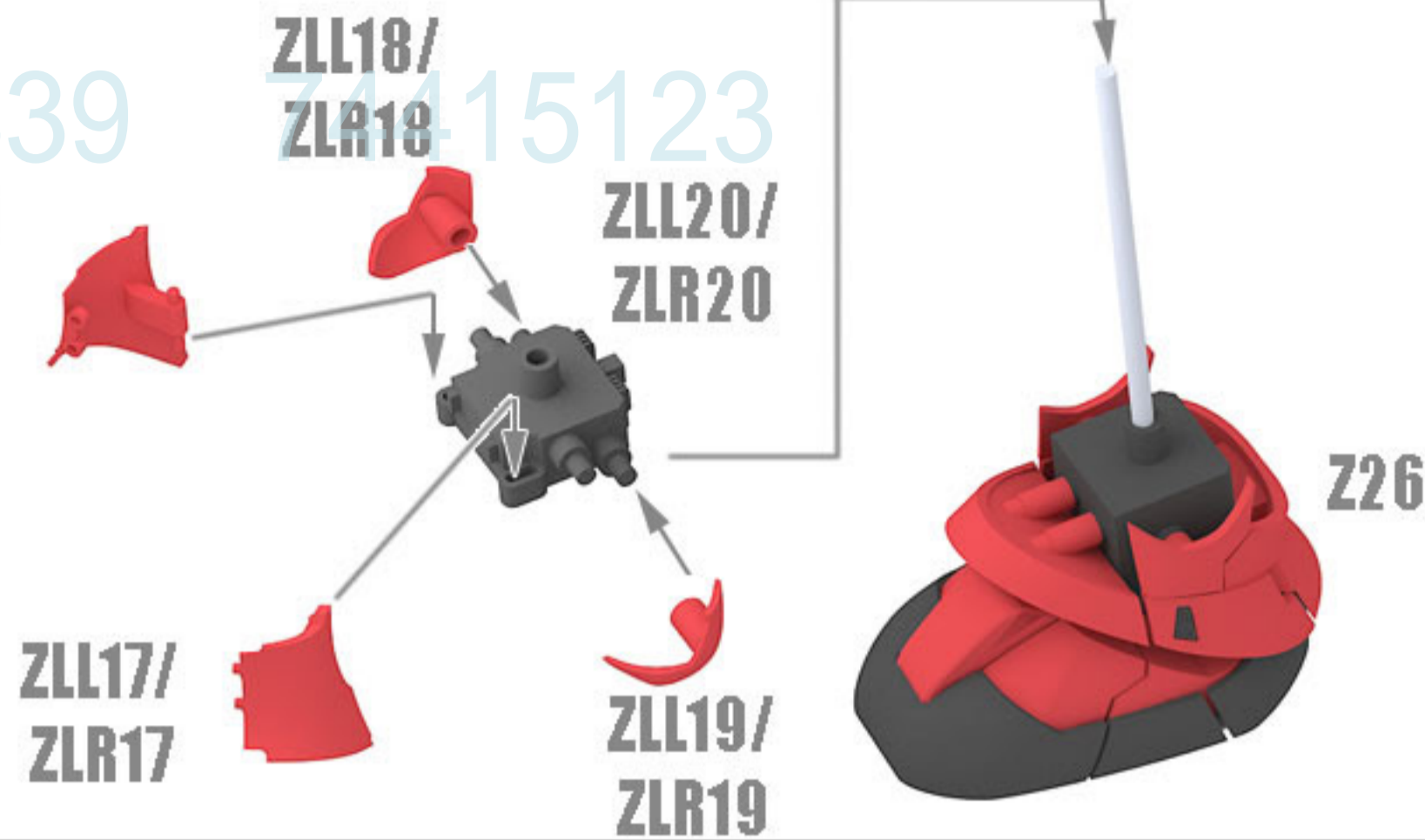

Z28

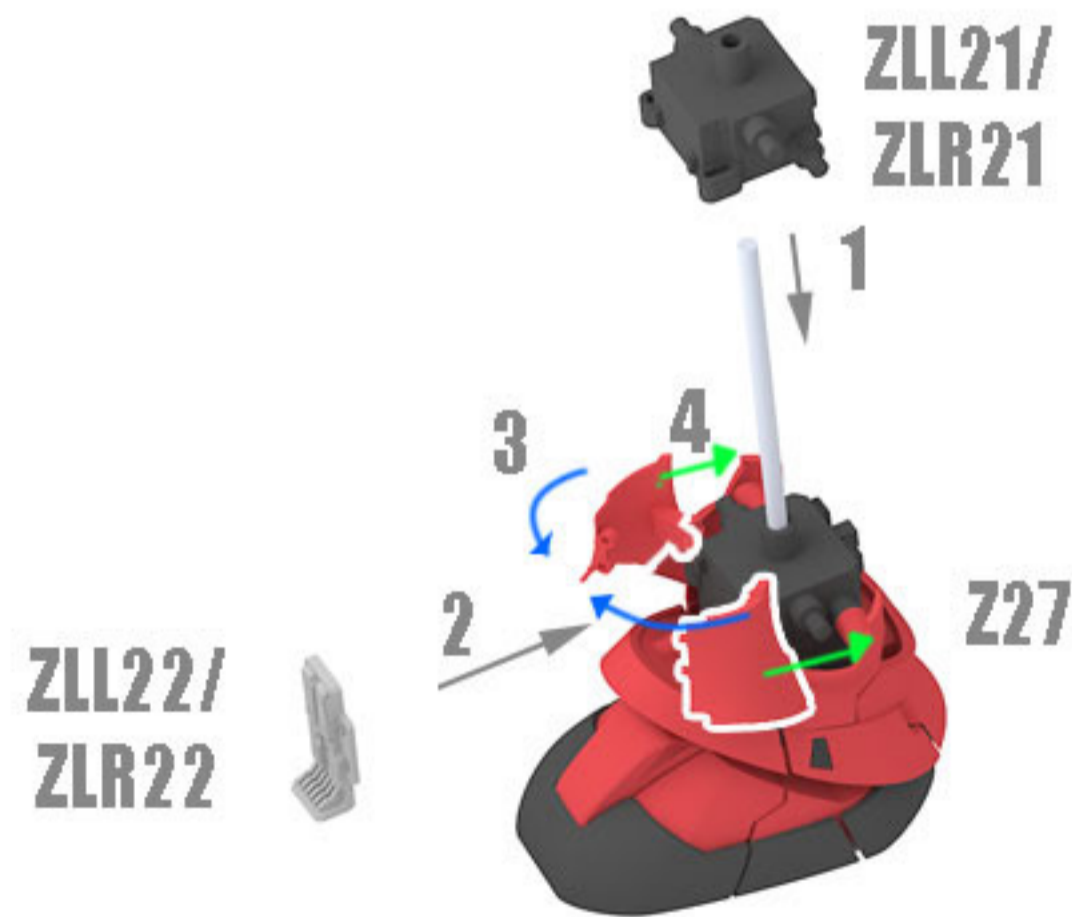

DESIGN AND CREATED BY KAIEI3D 2023

2023 年由KAIEI3D 设计与建模

PLEASE RESPECT TO THE DESIGNER EFFORT DO NOT STEAL DESIGN

请尊重设计师，切勿偷盗别人的设计

WARNING : Pirate pictures must be investigated 盗图必究

KAIEI3D
TOYS · GADGET · HOBBY

06
MS06 ZAKU-II

3D PRINT 1:20

BUST ADD-ON Ver.

Z29



Z31

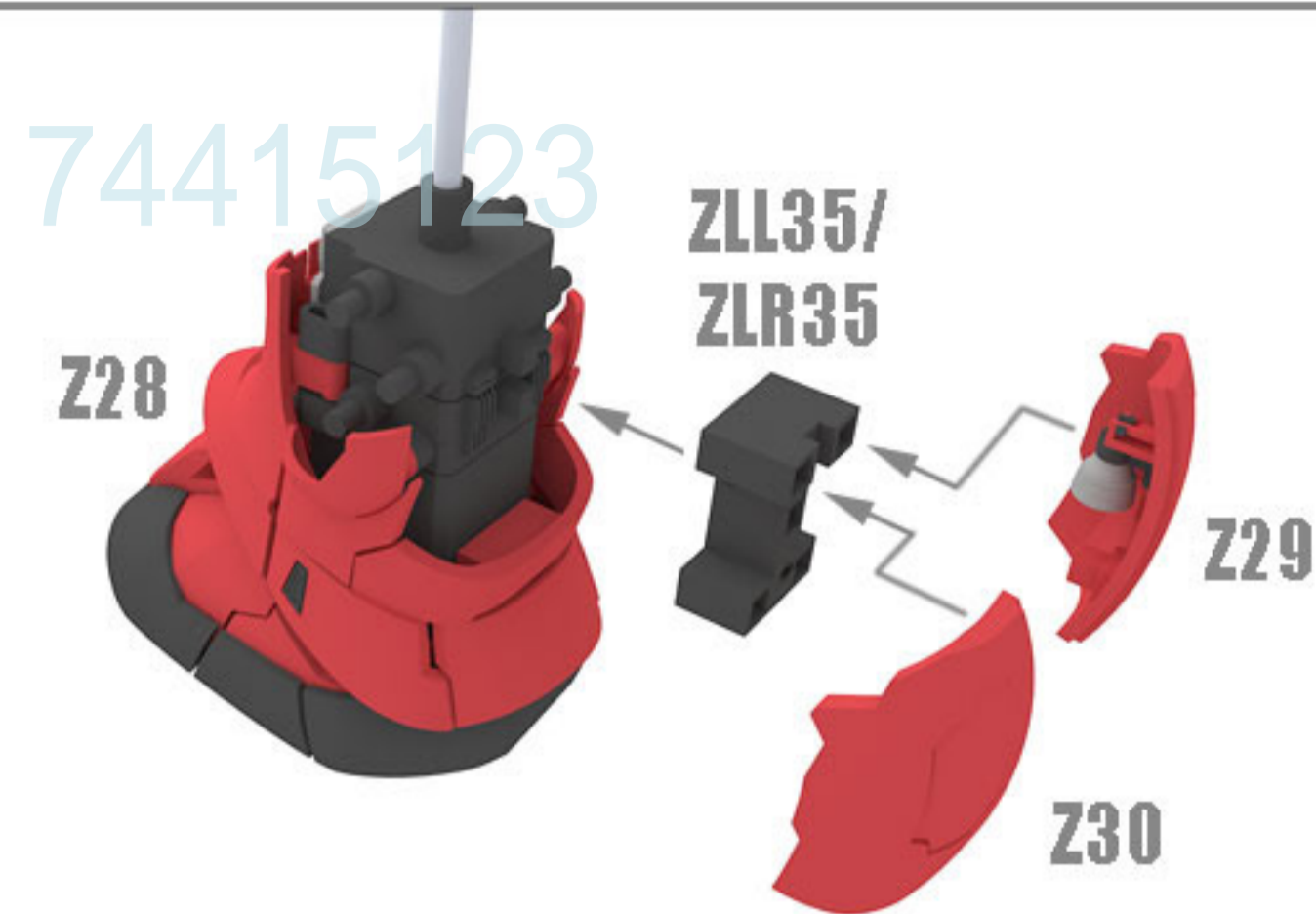

Z30

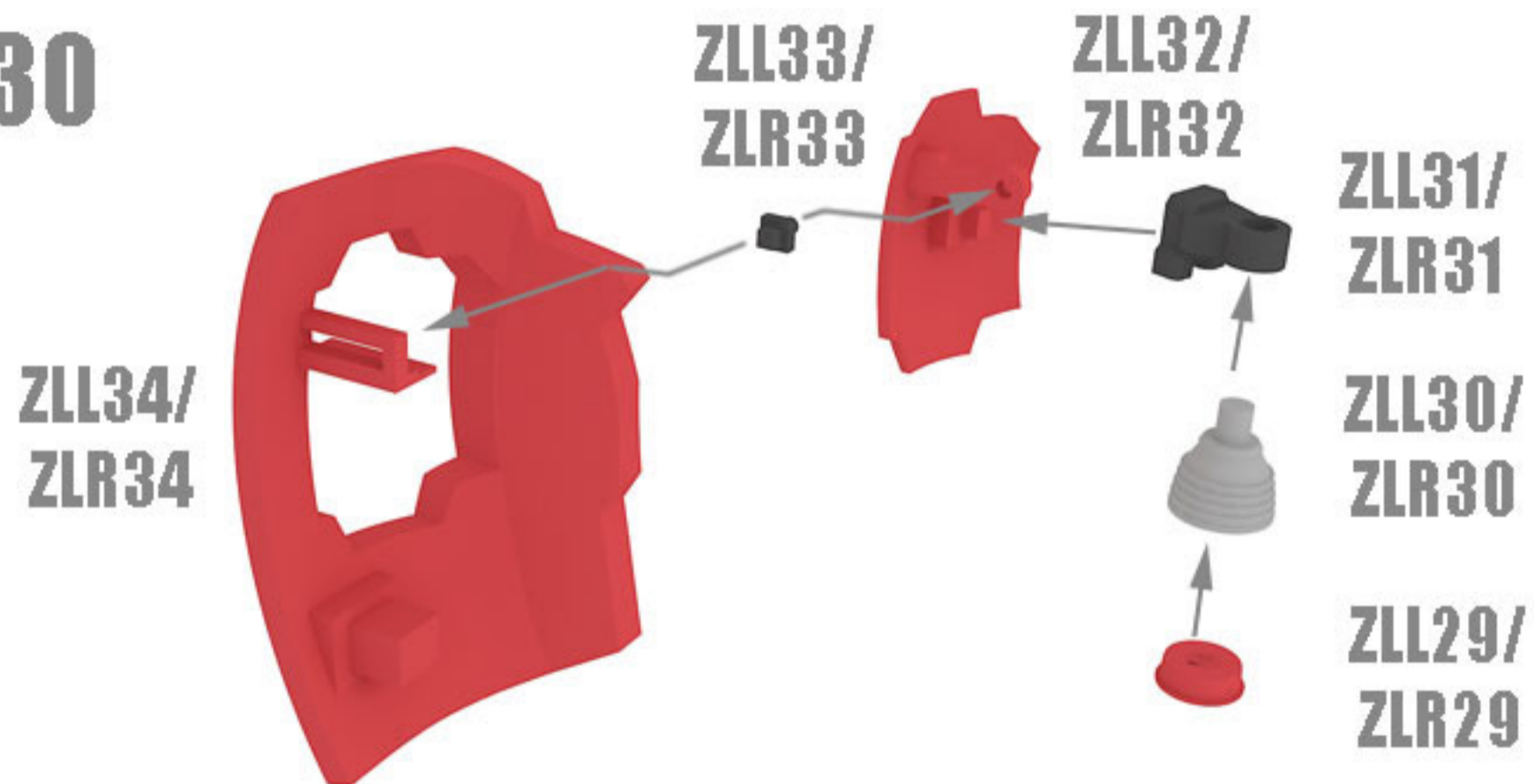

Z32

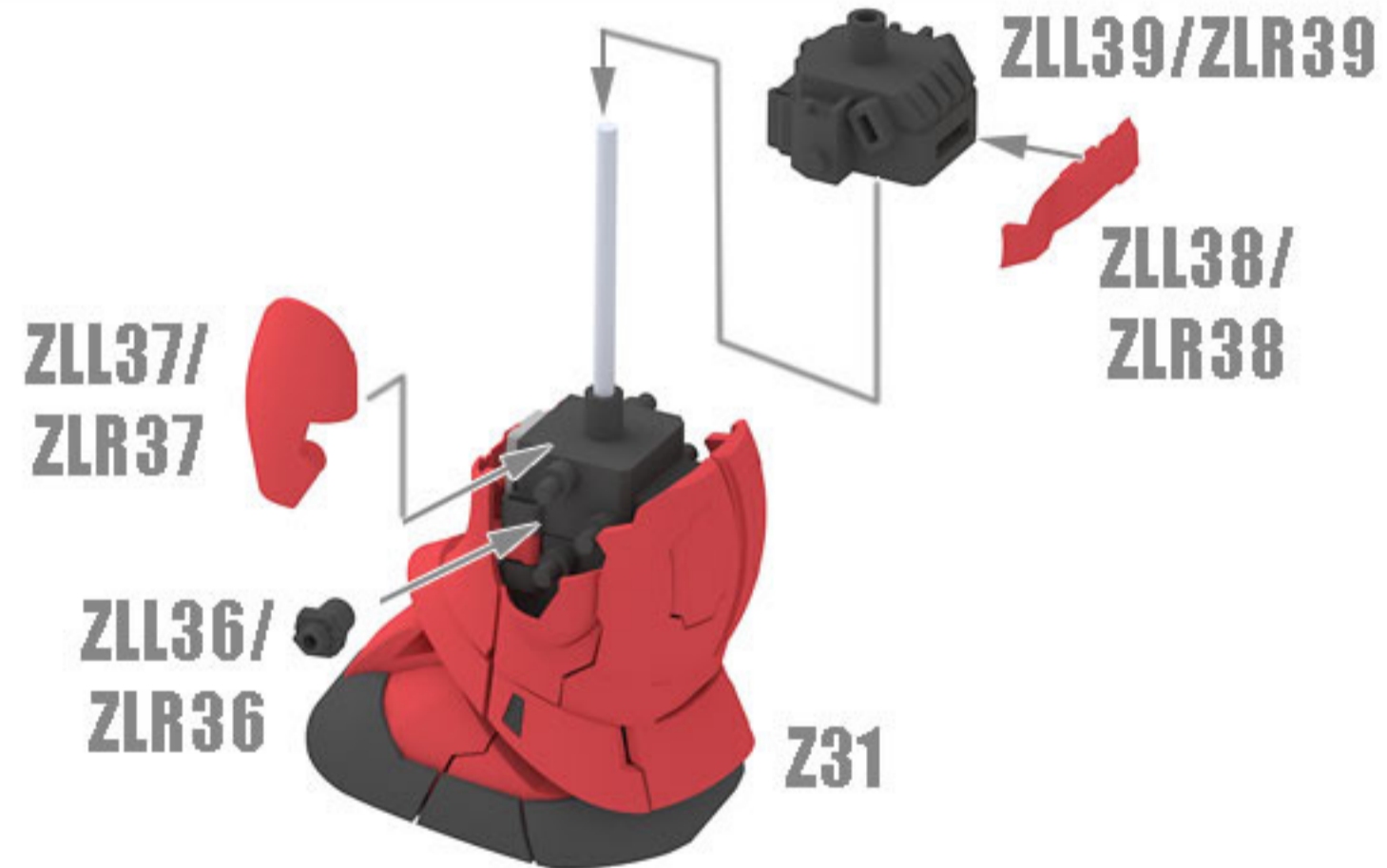

DESIGN AND CREATED BY KAIEI3D 2023

2023 年由KAIEI3D 设计与建模

PLEASE RESPECT TO THE DESIGNER EFFORT DO NOT STEAL DESIGN

请尊重设计师，切勿偷盗别人的设计

WARNING : Pirate pictures must be investigated 盗图必究



3D PRINT 1:20

BUST ADD-ON Ver.

Z33

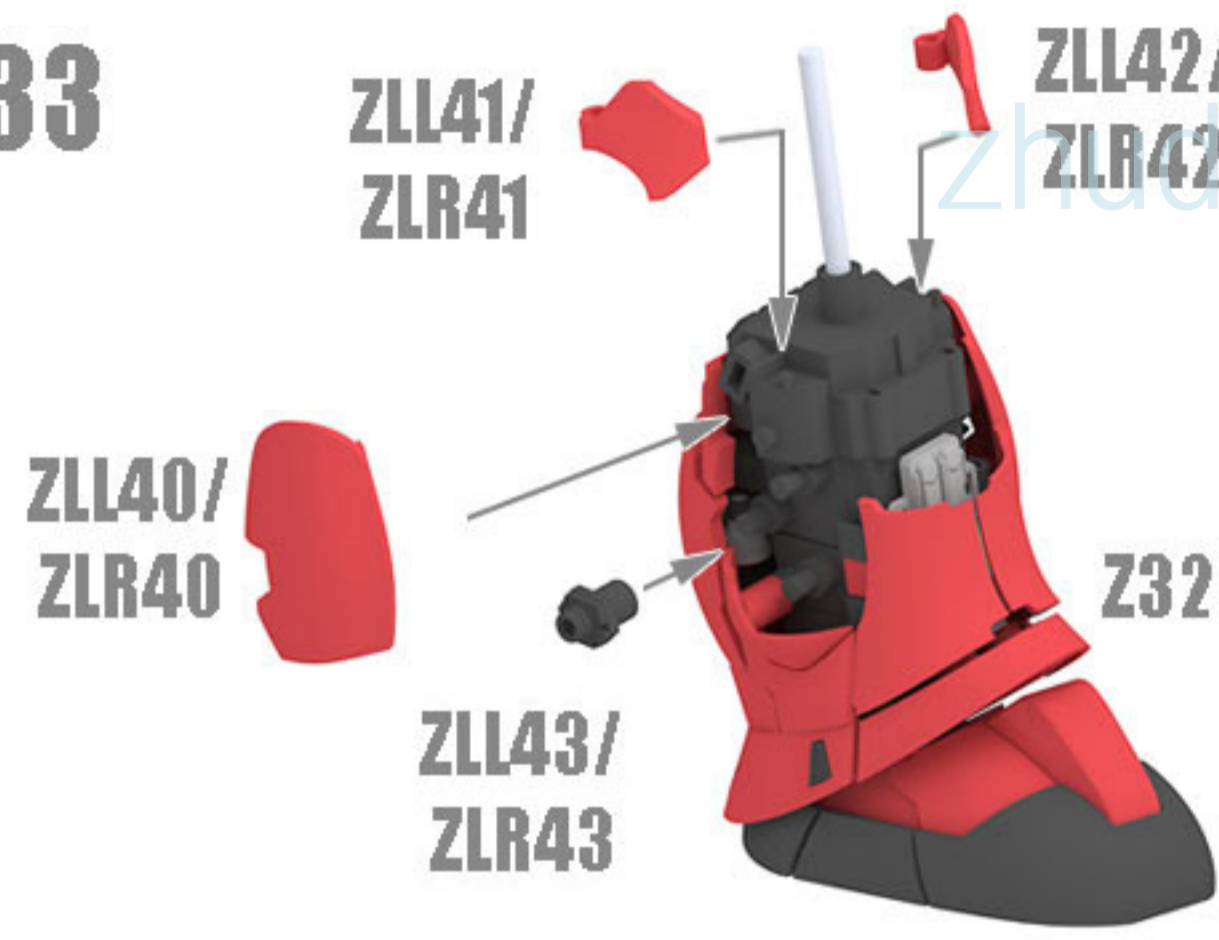

Z35

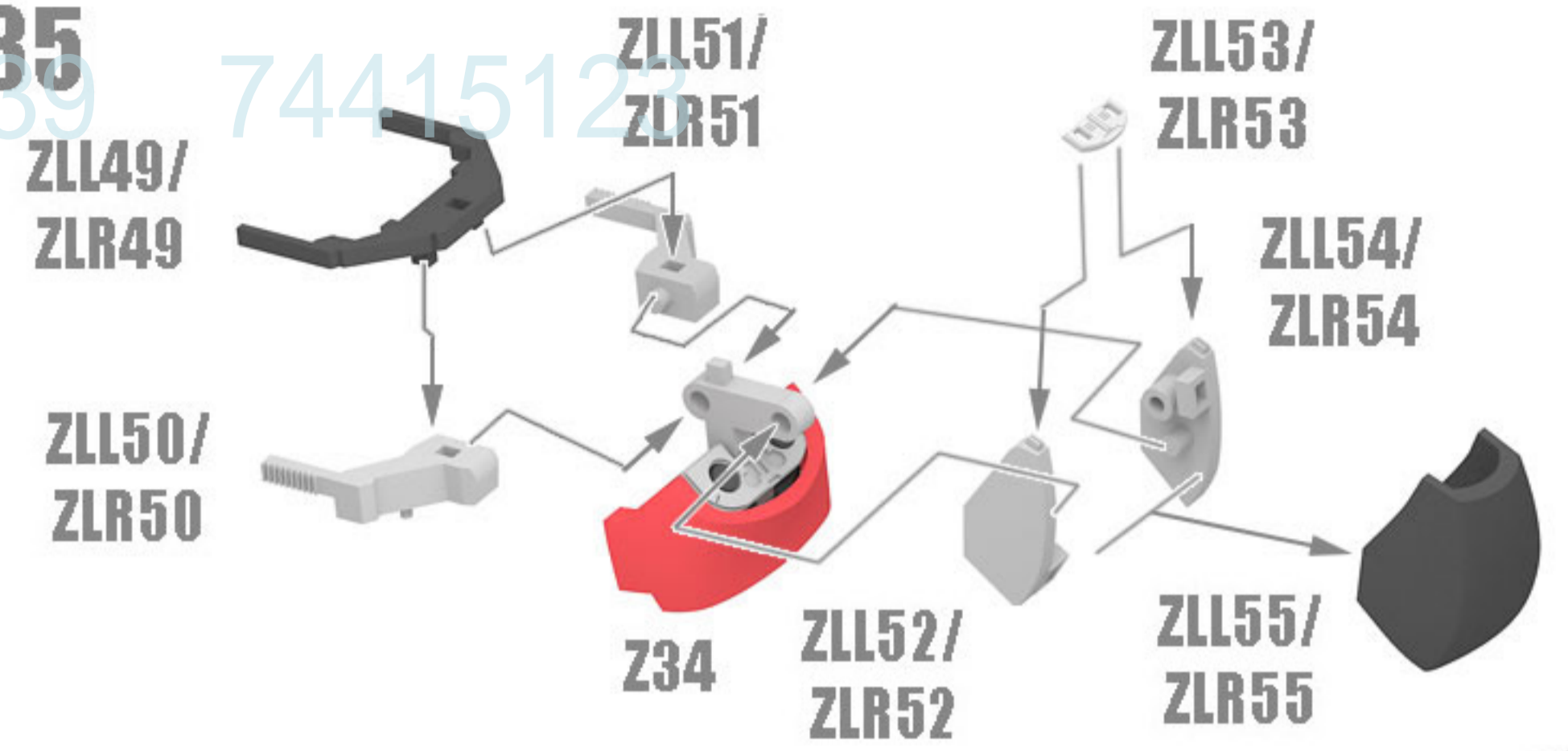

Z34

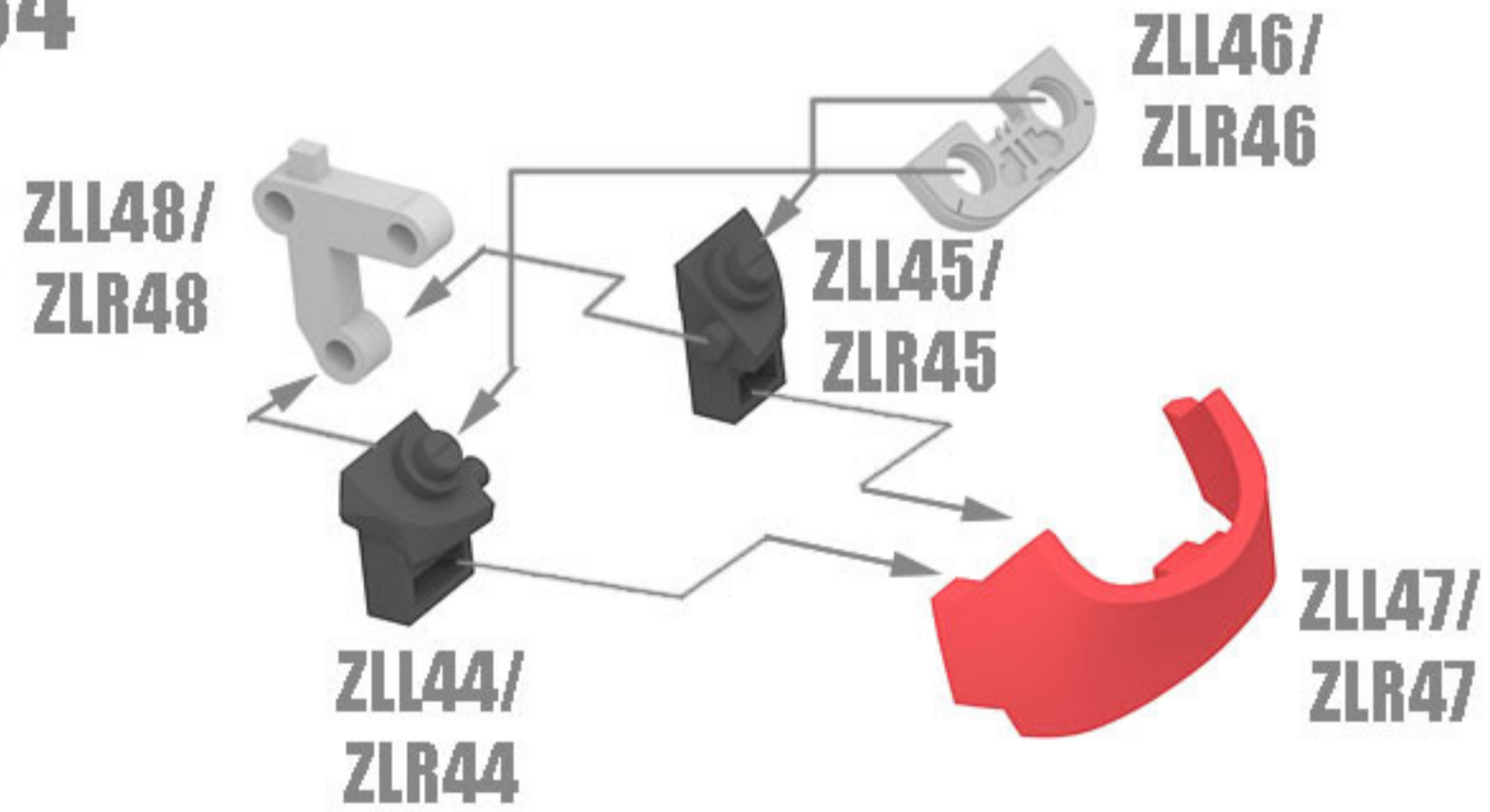

Z36

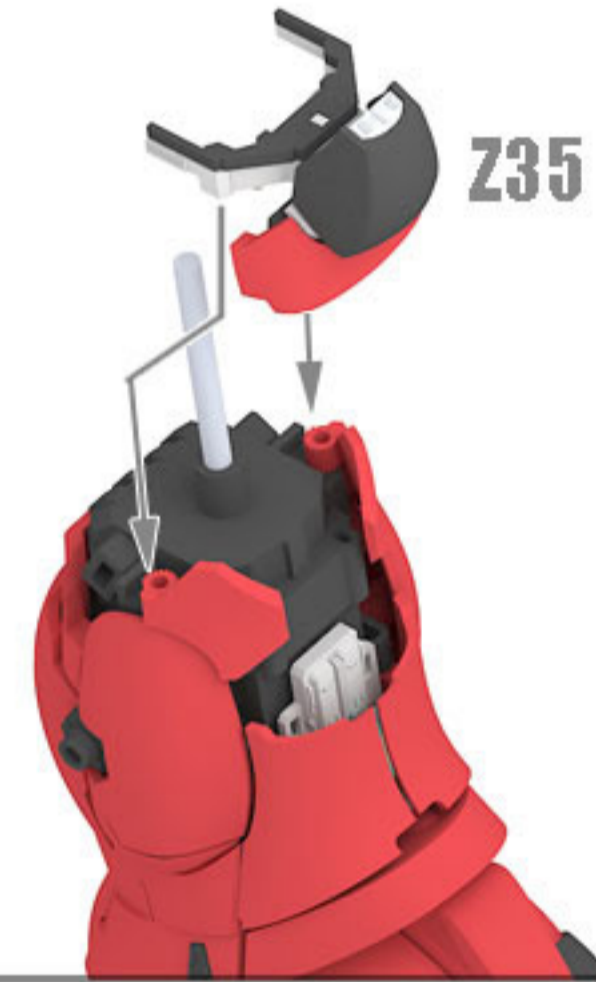

DESIGN AND CREATED BY KAIEI3D 2023

2023 年由KAIEI3D 设计与建模

PLEASE RESPECT TO THE DESIGNER EFFORT DO NOT STEAL DESIGN

请尊重设计师，切勿偷盗别人的设计

WARNING : Pirate pictures must be investigated 盗图必究



3D PRINT 1:20

BUST ADD-ON Ver.

Z37

ZLL56/
ZLR56

ZLL58/
ZLR58

ZLL57/
ZLR57

Z36



Z38

ZLL60/
ZLR60

ZLL59/
ZLR59

ZLL62/
ZLR62

ZLL61/
ZLR61

Z37

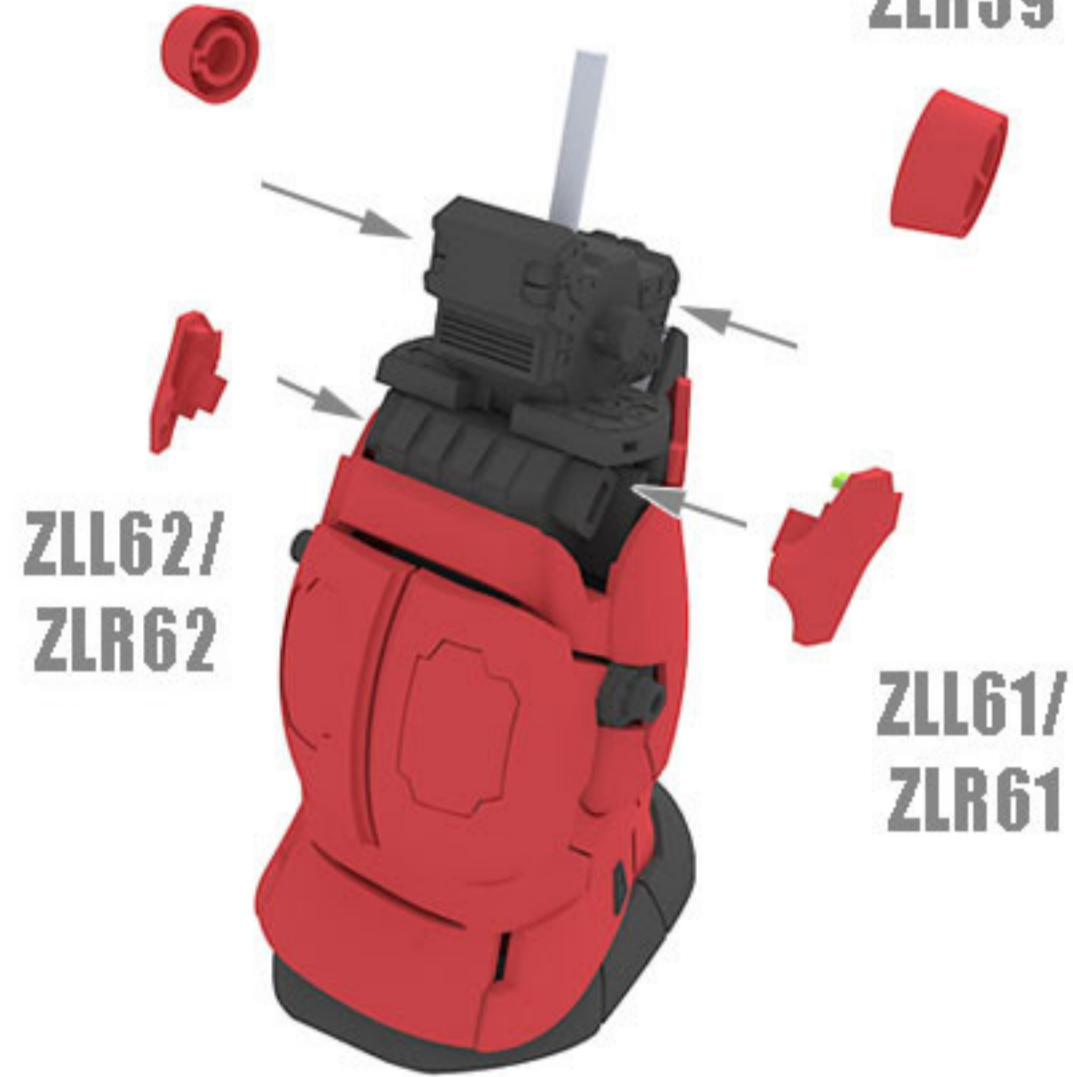

Z39

ZLL64/
ZLR64

ZLL66/
ZLR66

ZLL69/
ZLR69

ZLL67/
ZLR67

ZLL71/
ZLR71

ZLL70/
ZLR70

ZLL68/
ZLR68

ZLL63/
ZLR63

ZLL65/
ZLR65

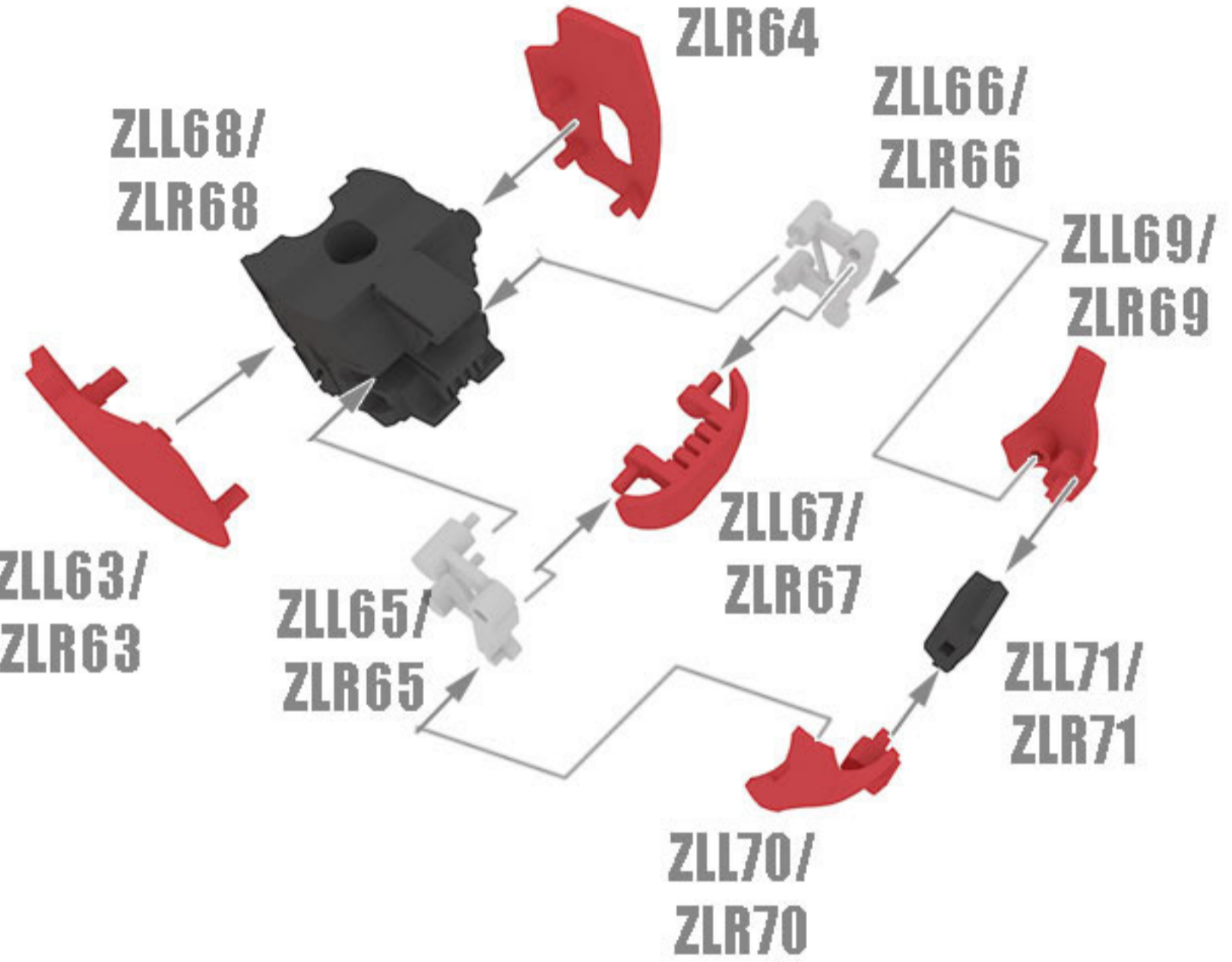

DESIGN AND CREATED BY KAIEI3D 2023

2023 年由KAIEI3D 设计与建模

PLEASE RESPECT TO THE DESIGNER EFFORT DO NOT STEAL DESIGN

请尊重设计师，切勿偷盗别人的设计

WARNING : Pirate pictures must be investigated 盗图必究



3D PRINT 1:20

BUST ADD-ON Ver.

Z40

ZLL74/
ZLR74

ZLL72/
ZLR72

ZLL73/
ZLR73

ZLL75/
ZLR75

ZLL76/
ZLR76

ZLL77/
ZLR77

ZLL78/
ZLR78

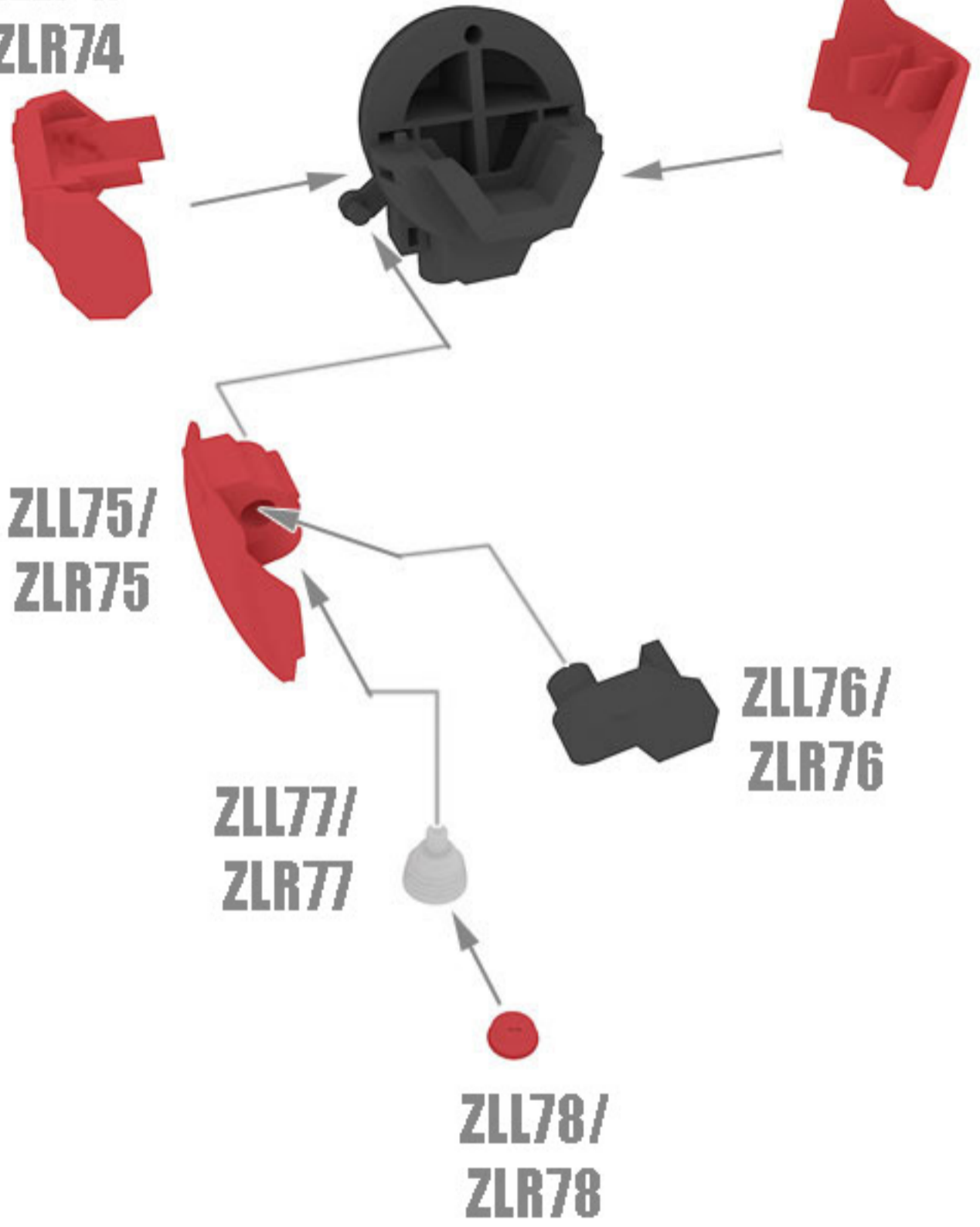

Z41

Z40

Z39

Z38

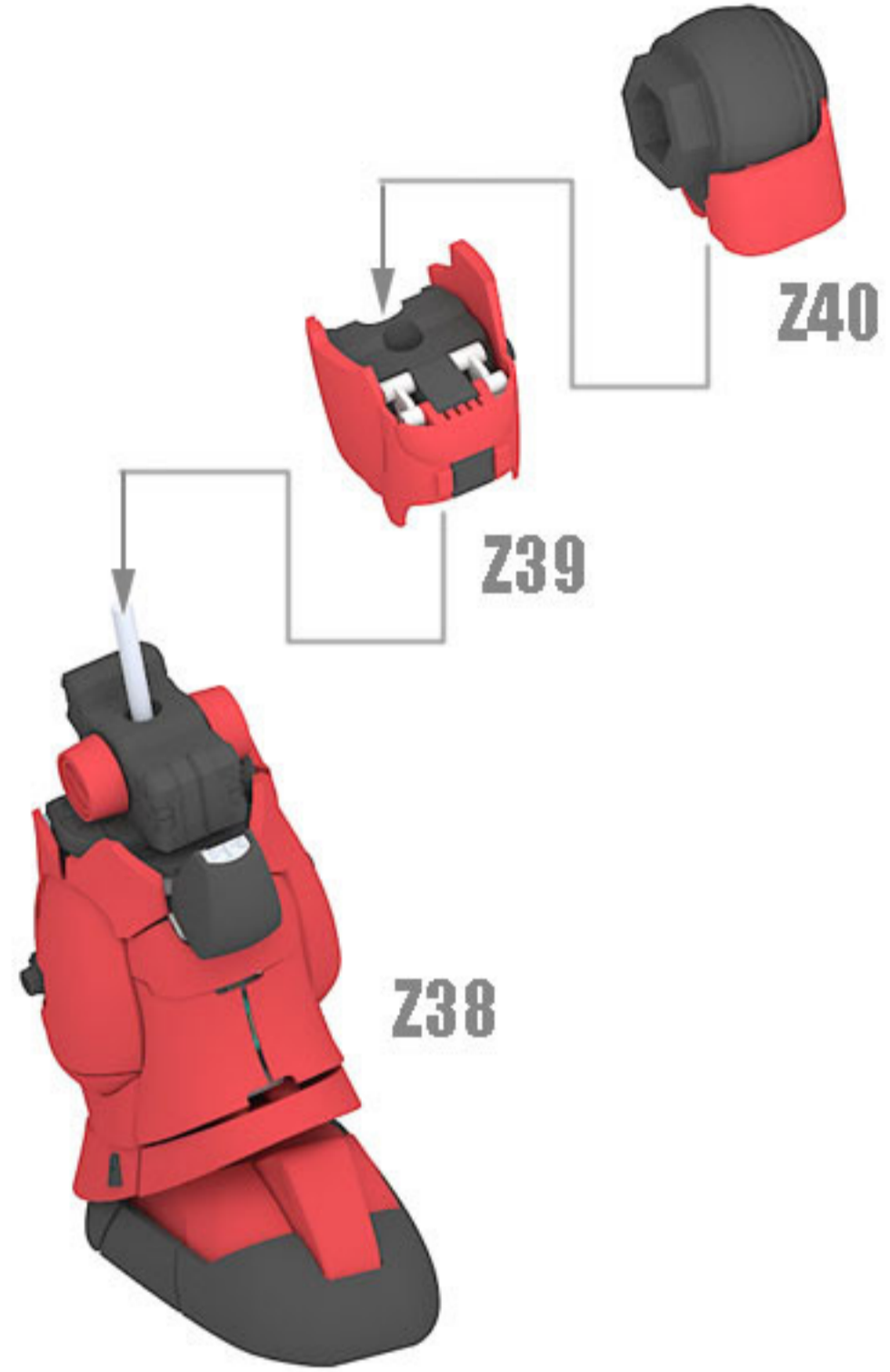

Z42

HC7

HC8

HC2

HC2

HC3 x9

HC6 x8



Z43

Z42

Z41

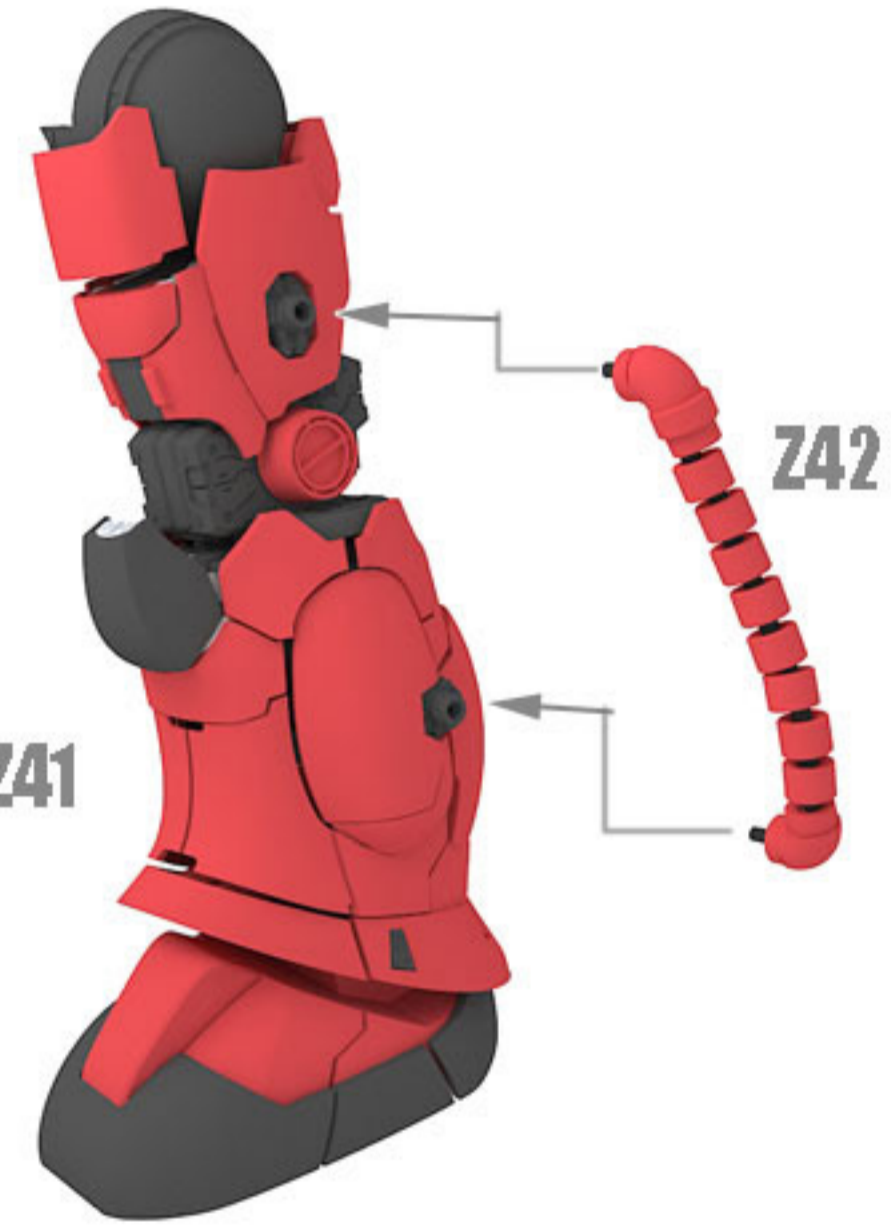

DESIGN AND CREATED BY KAIEI3D 2023

2023 年由KAIEI3D 设计与建模

PLEASE RESPECT TO THE DESIGNER EFFORT DO NOT STEAL DESIGN

请尊重设计师，切勿偷盗别人的设计

WARNING : Pirate pictures must be investigated 盗图必究

KAIEI3D

TOYS · GADGET · HOBBY

06
MS06 ZAKU-II

3D PRINT 1:20

BUST ADD-ON Ver.

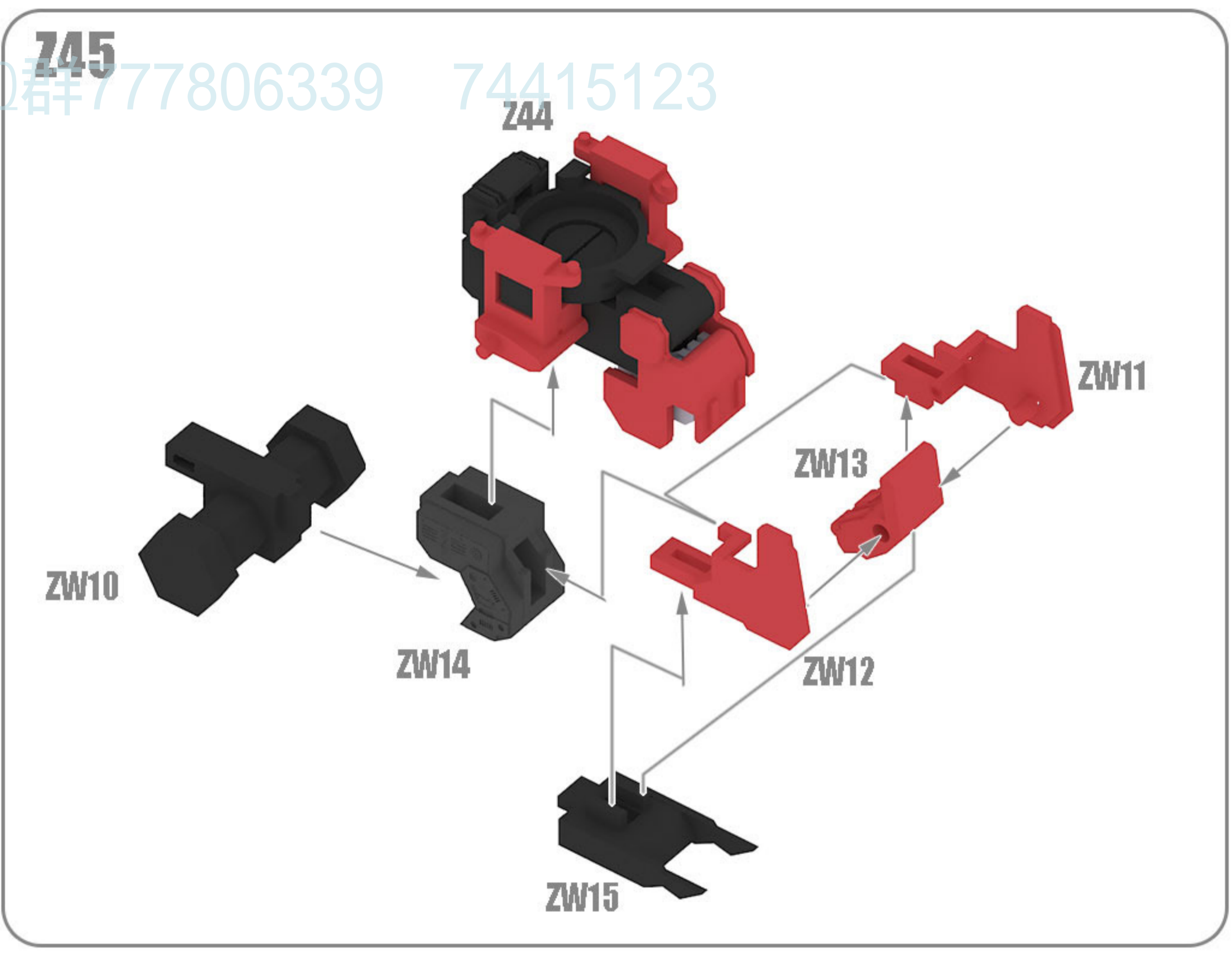
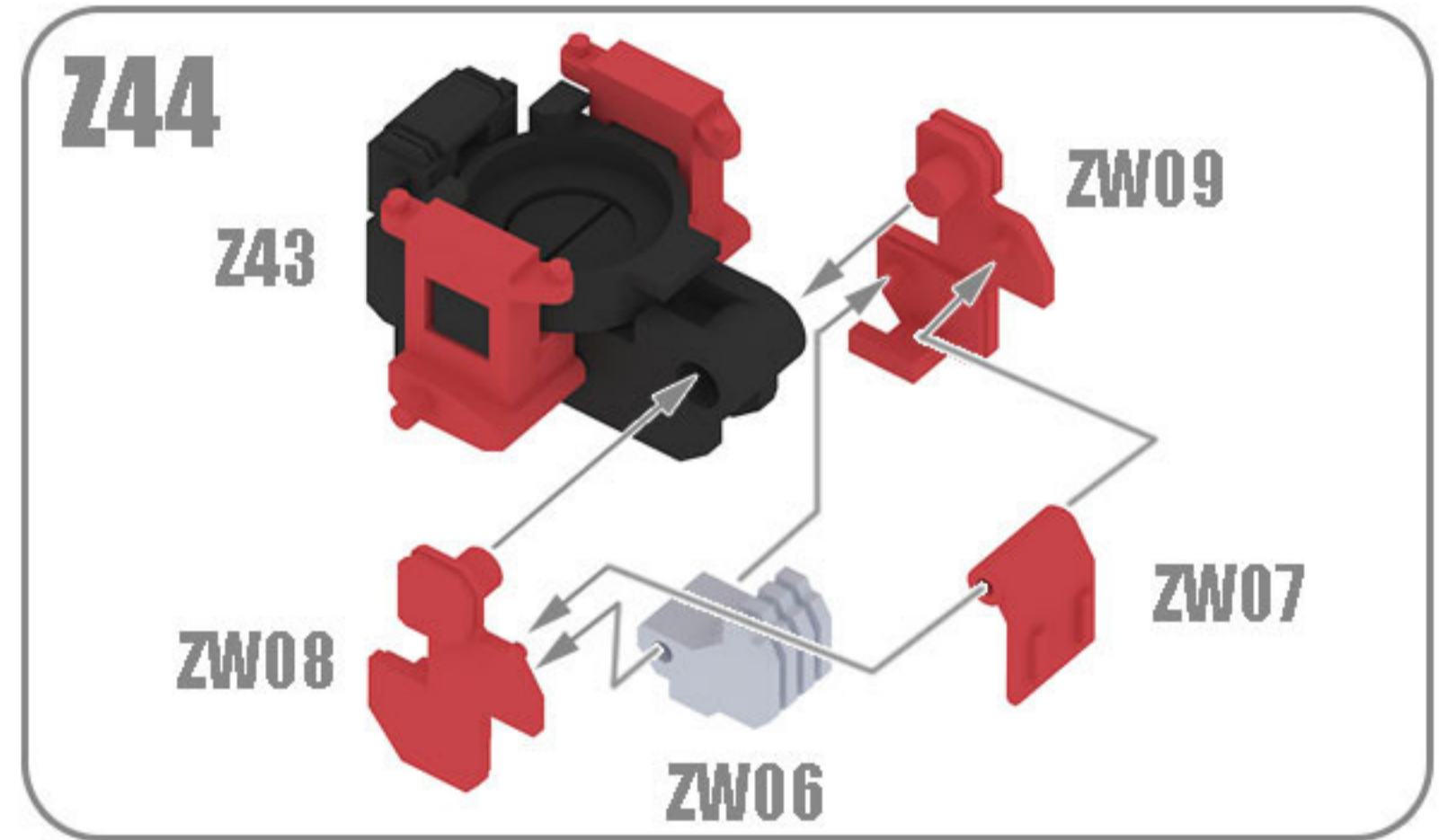
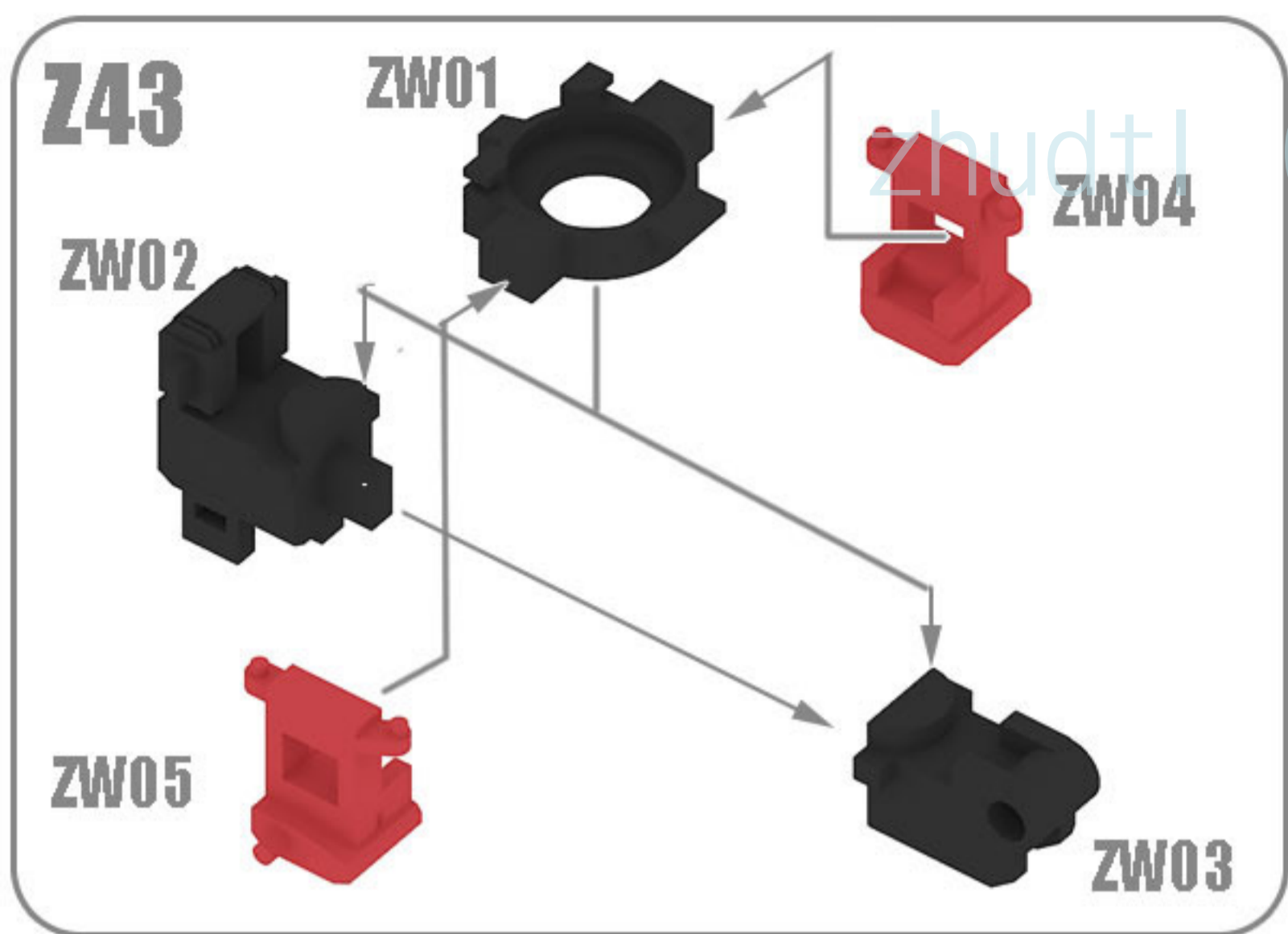

zhudt... Q群777806339 74415123

DESIGN AND CREATED BY KAIEI3D 2023
 2023 年由KAIEI3D 设计与建模
 PLEASE RESPECT TO THE DESIGNER EFFORT DO NOT STEAL DESIGN
 请尊重设计师，切勿偷盗别人的设计
 WARNING : Pirate pictures must be investigated 盗图必究



Z46

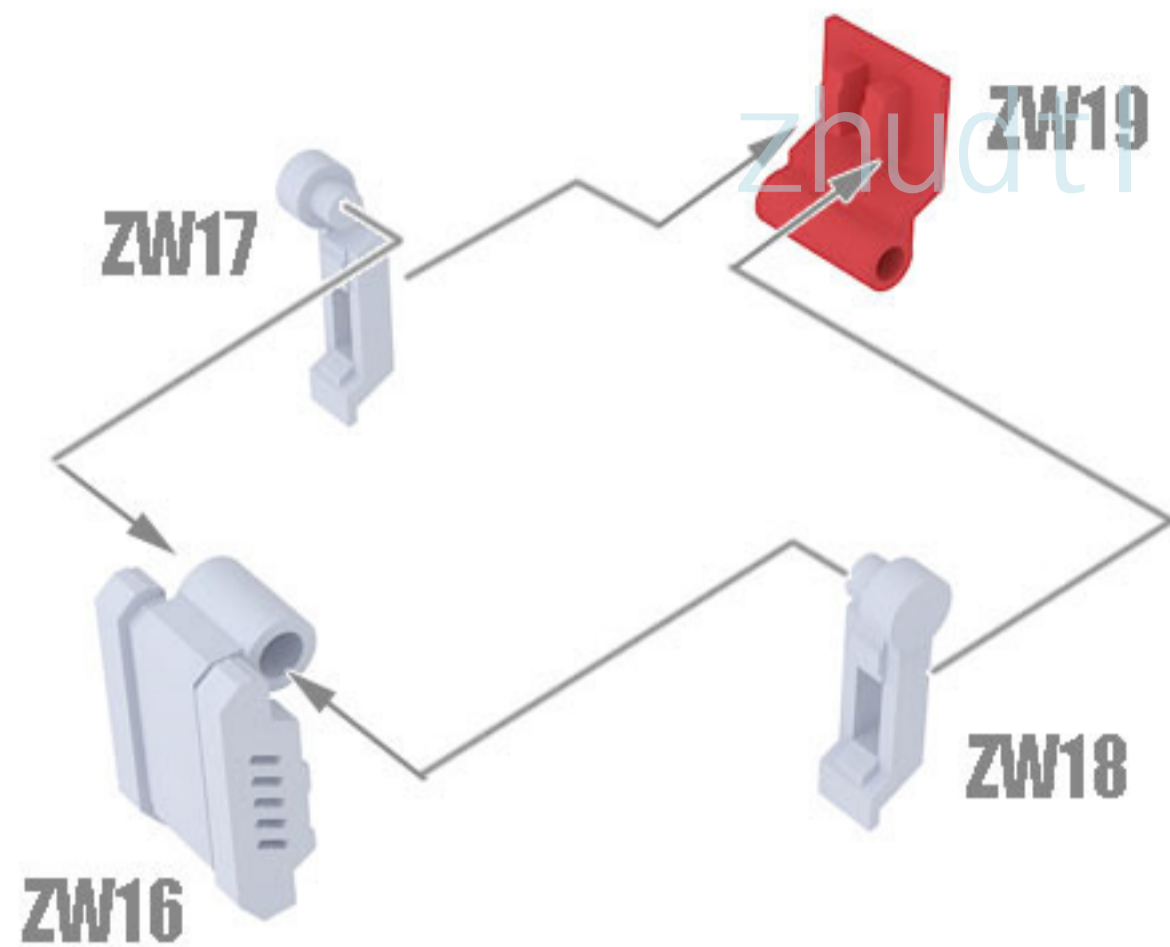

Z48

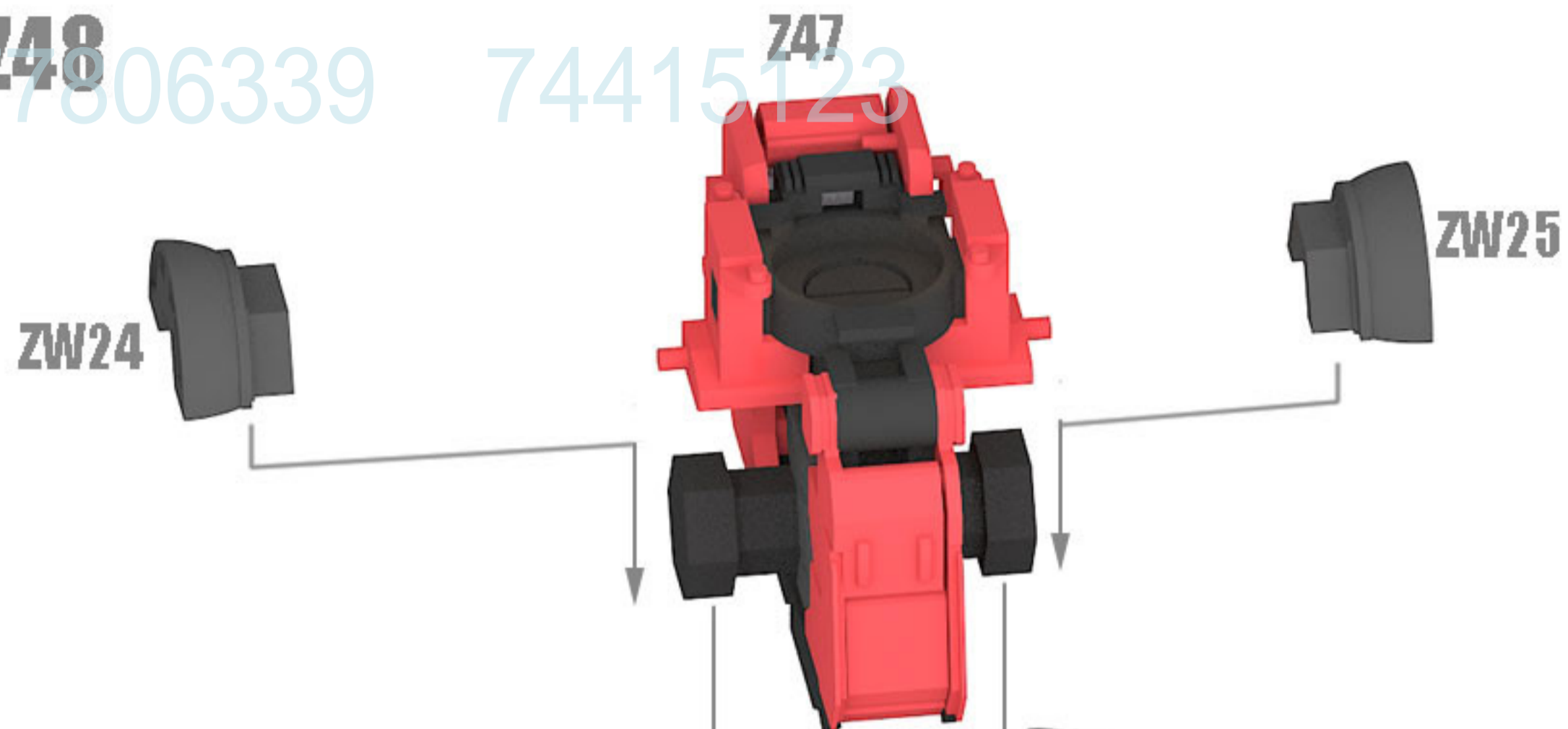

Z47

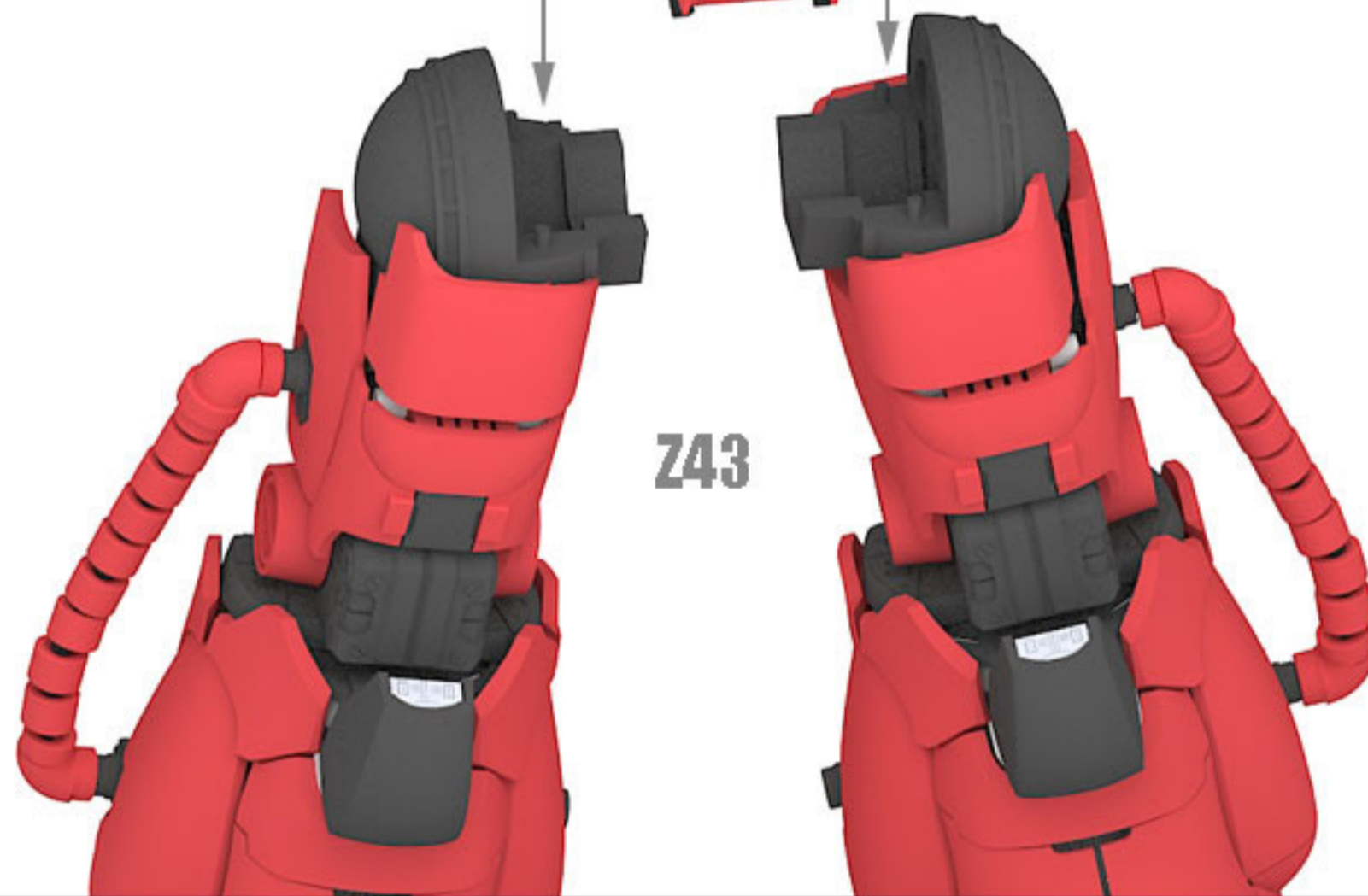
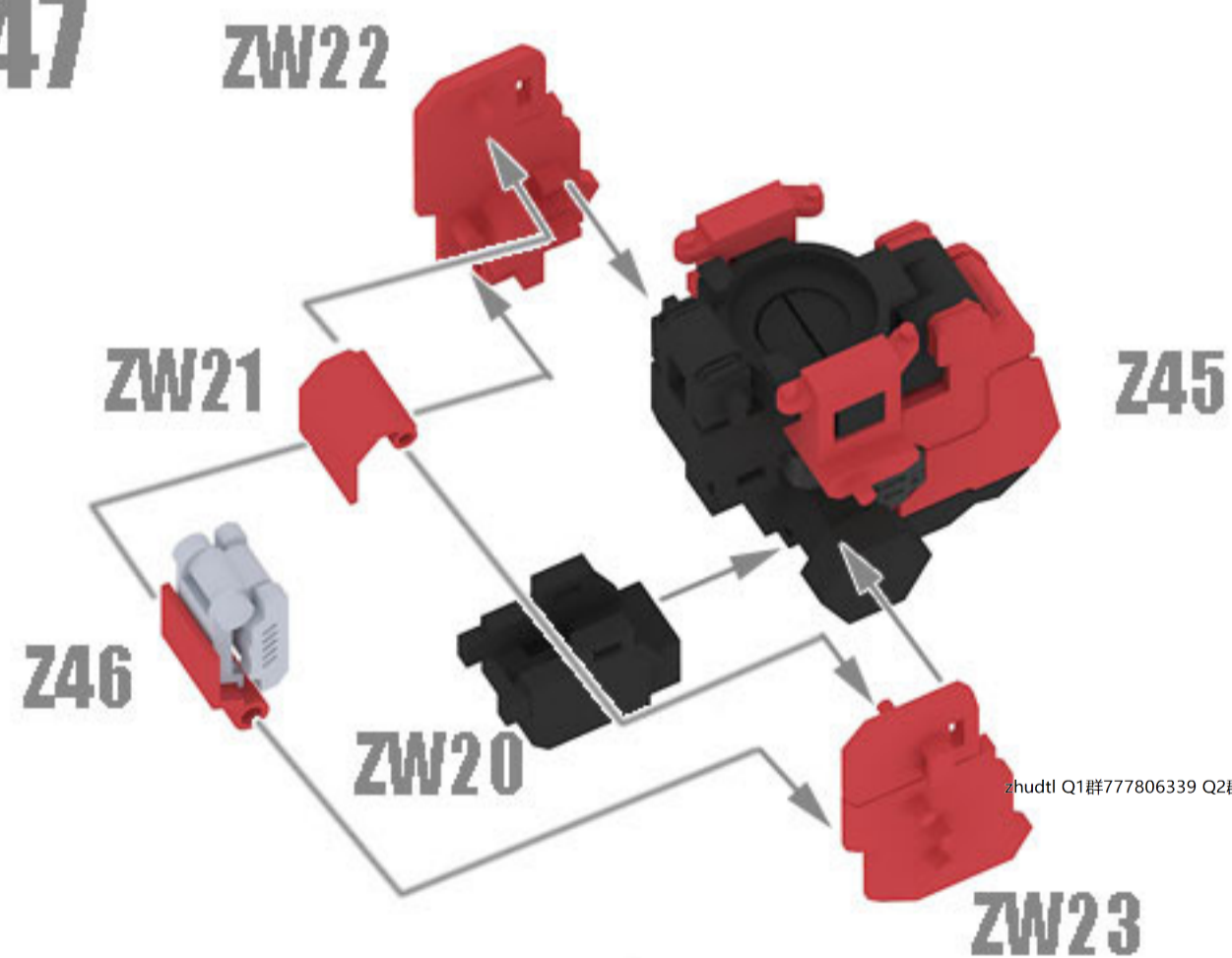

DESIGN AND CREATED BY KAIEI3D 2023

2023 年由KAIEI3D 设计与建模

PLEASE RESPECT TO THE DESIGNER EFFORT DO NOT STEAL DESIGN

请尊重设计师，切勿偷盗别人的设计

WARNING : Pirate pictures must be investigated 盗图必究



TOYS · GADGET · HOBBY



3D PRINT 1:20

BUST ADD-ON Ver.

Z49

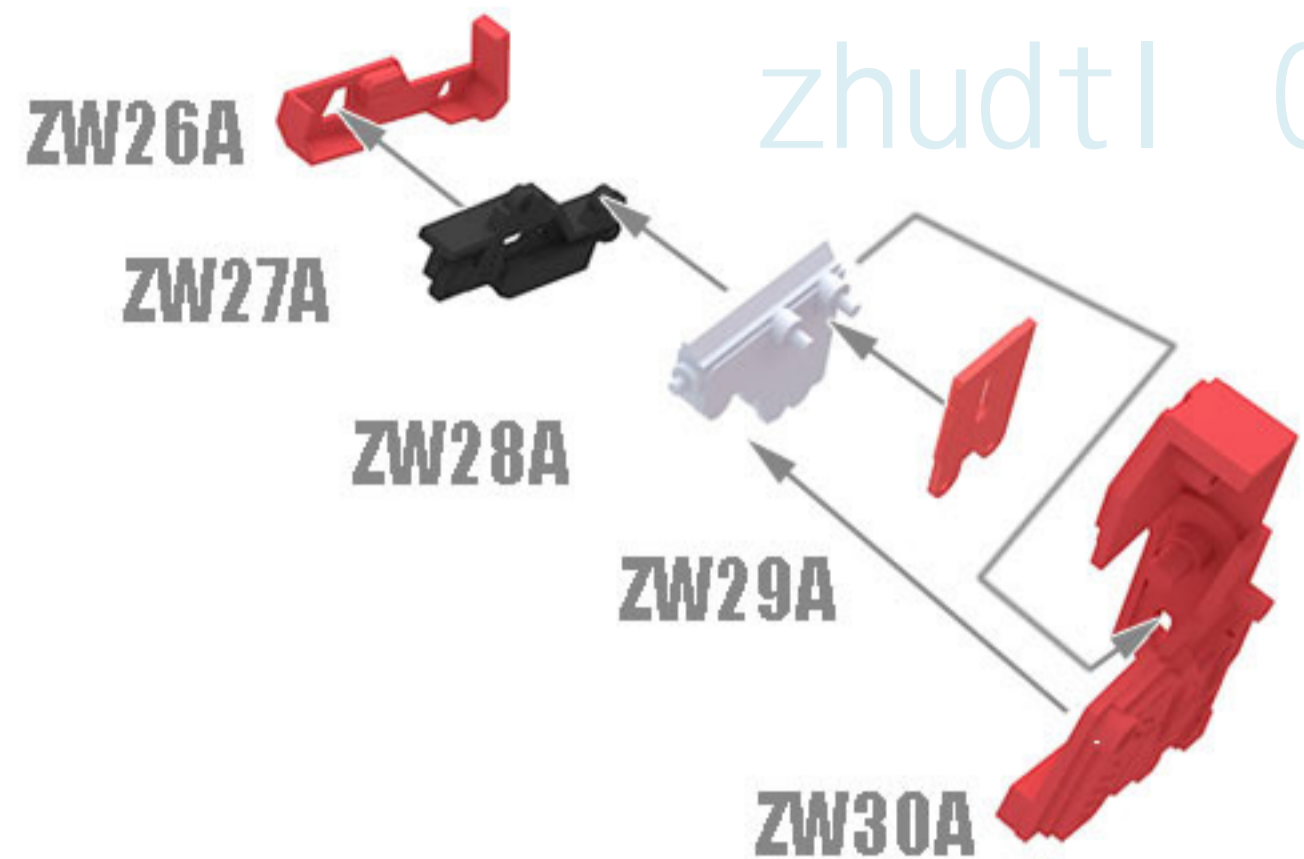

Z51

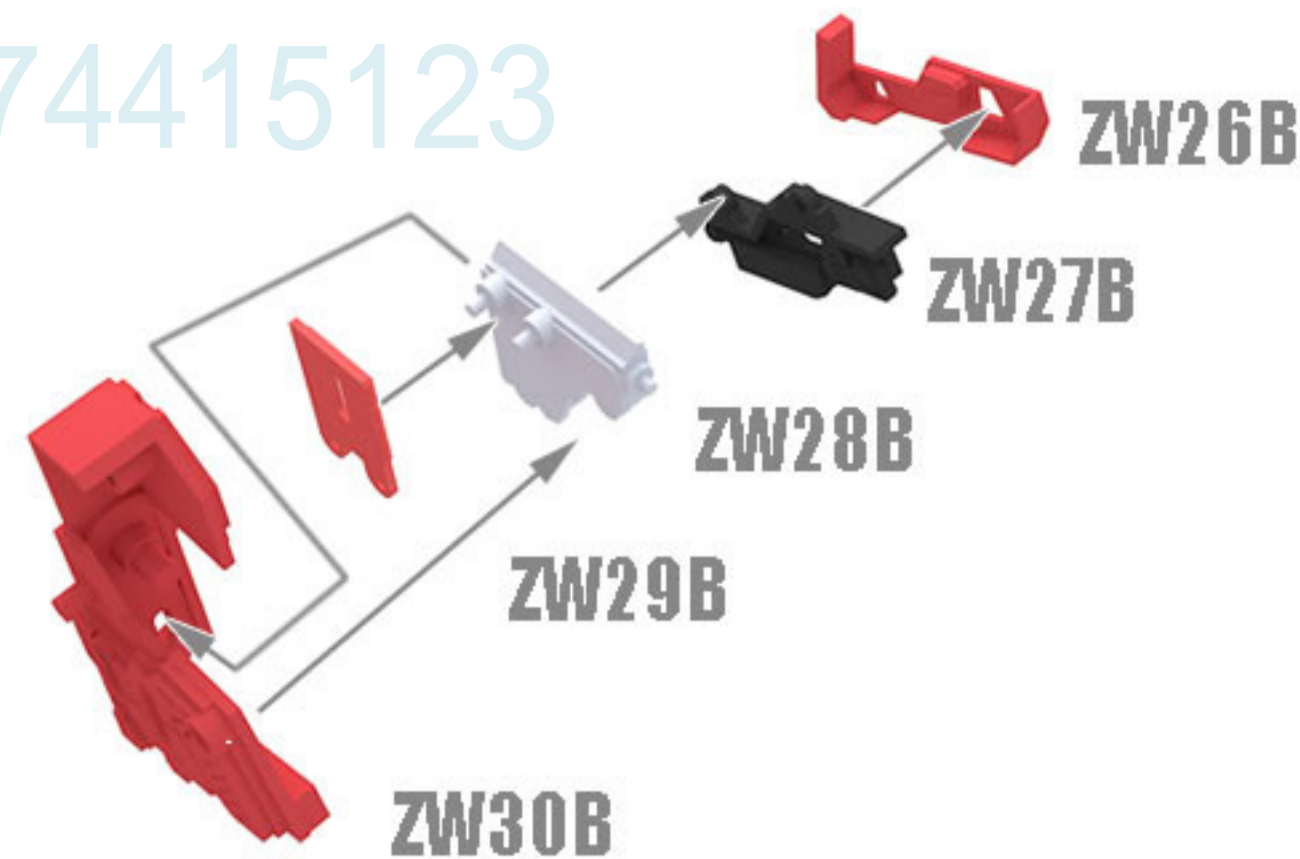

Z50

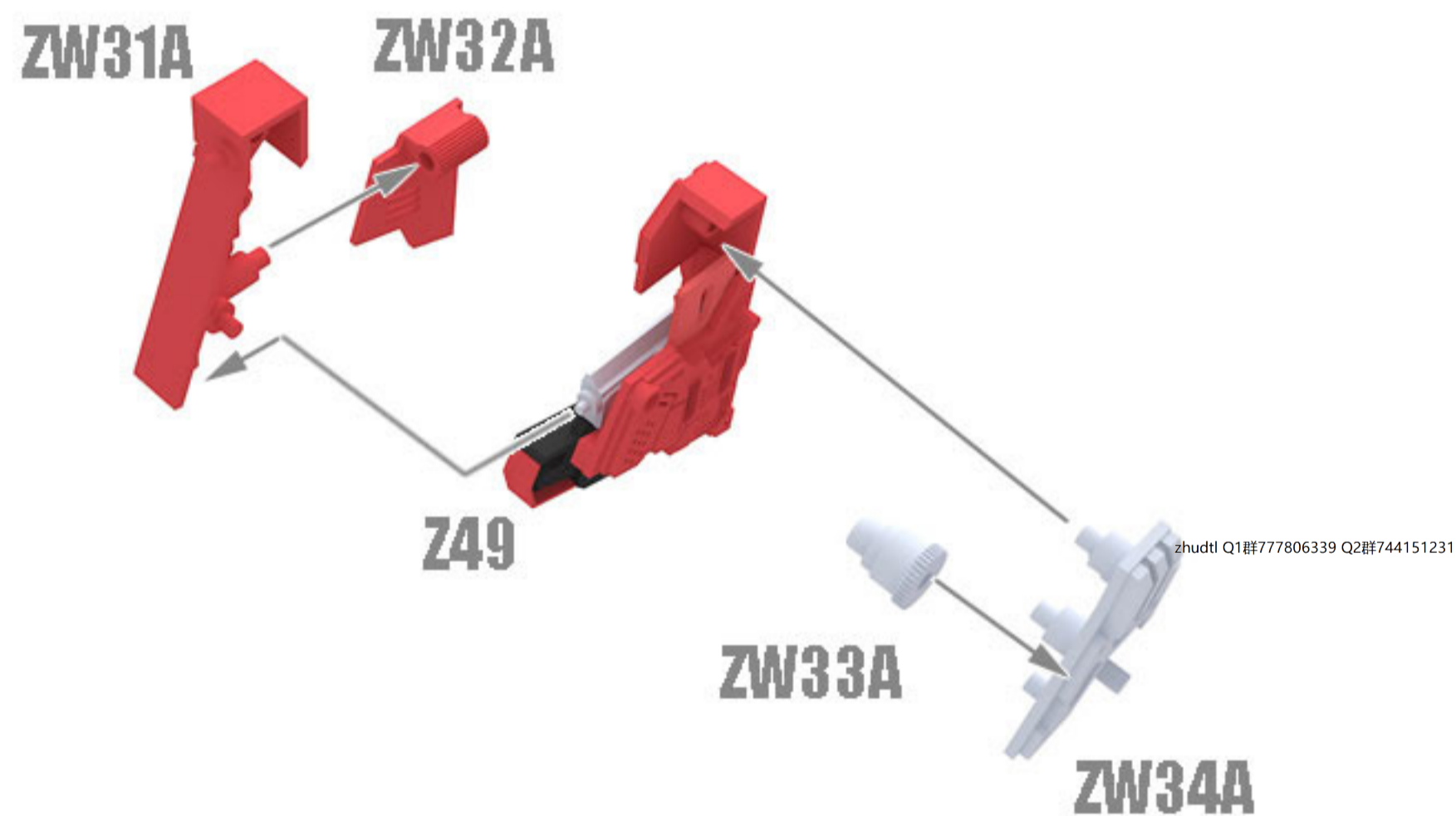

Z52

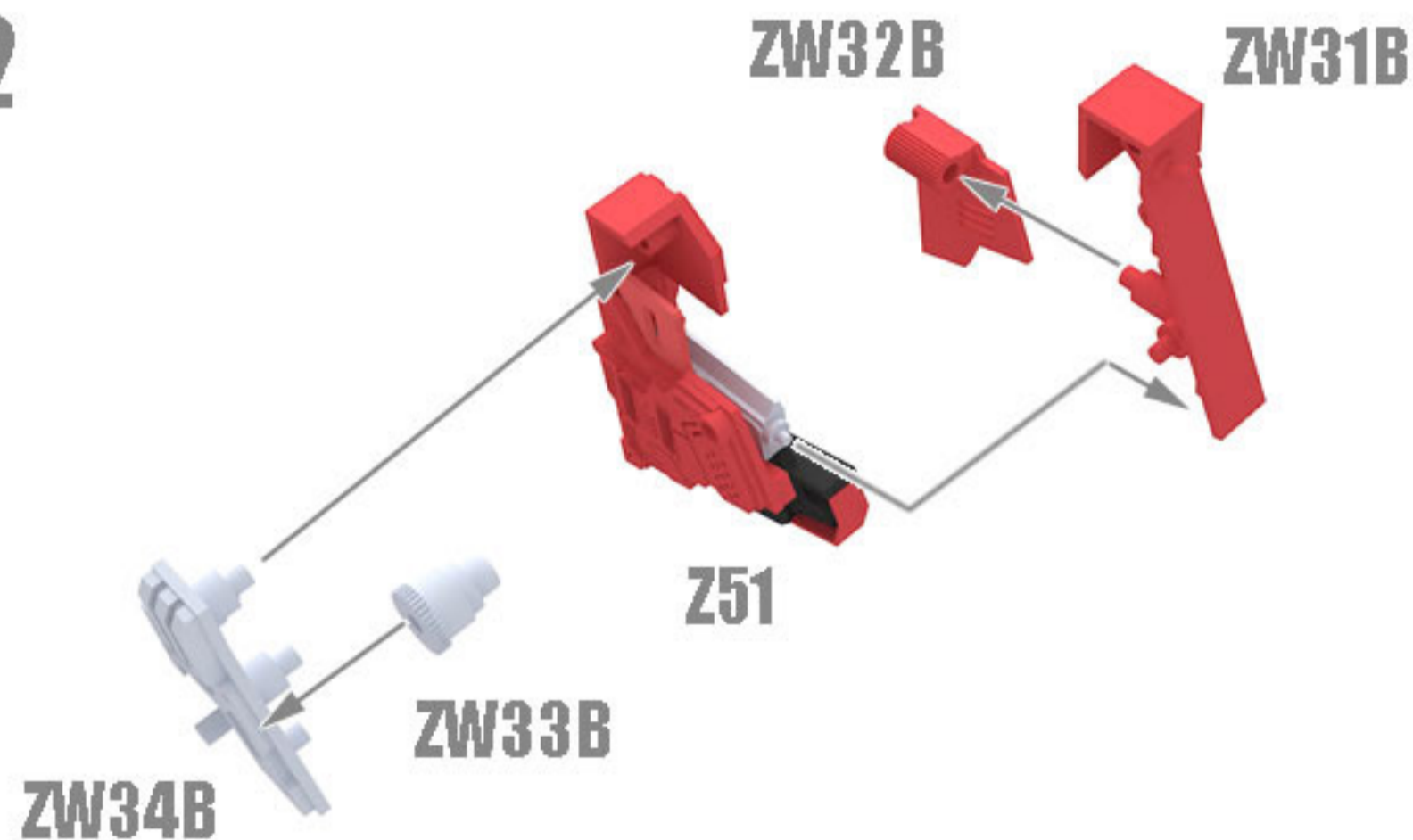

DESIGN AND CREATED BY KAIEI3D 2023

2023 年由KAIEI3D 设计与建模

PLEASE RESPECT TO THE DESIGNER EFFORT DO NOT STEAL DESIGN

请尊重设计师，切勿偷盗别人的设计

WARNING : Pirate pictures must be investigated 盗图必究



3D PRINT 1:20

BUST ADD-ON Ver.

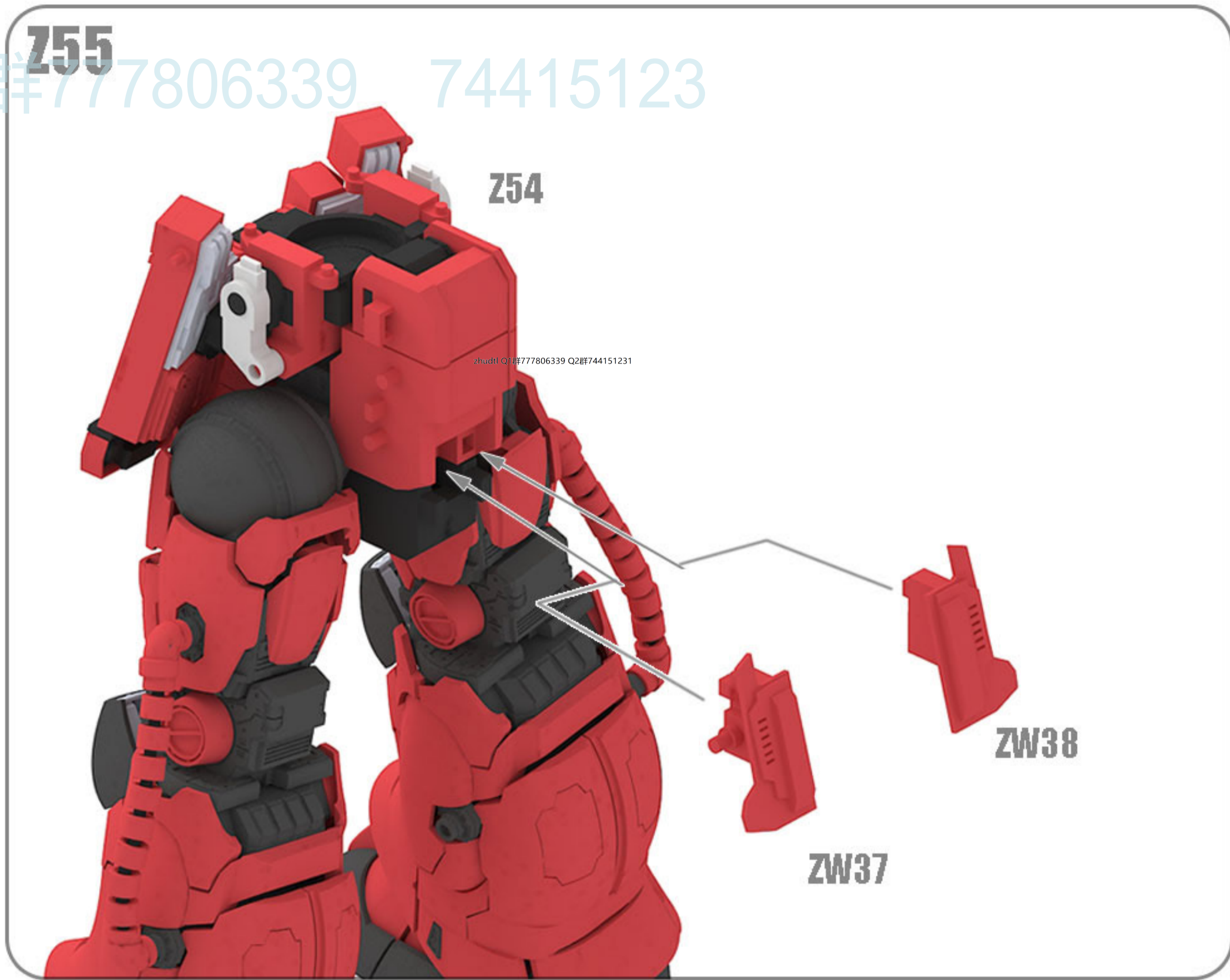
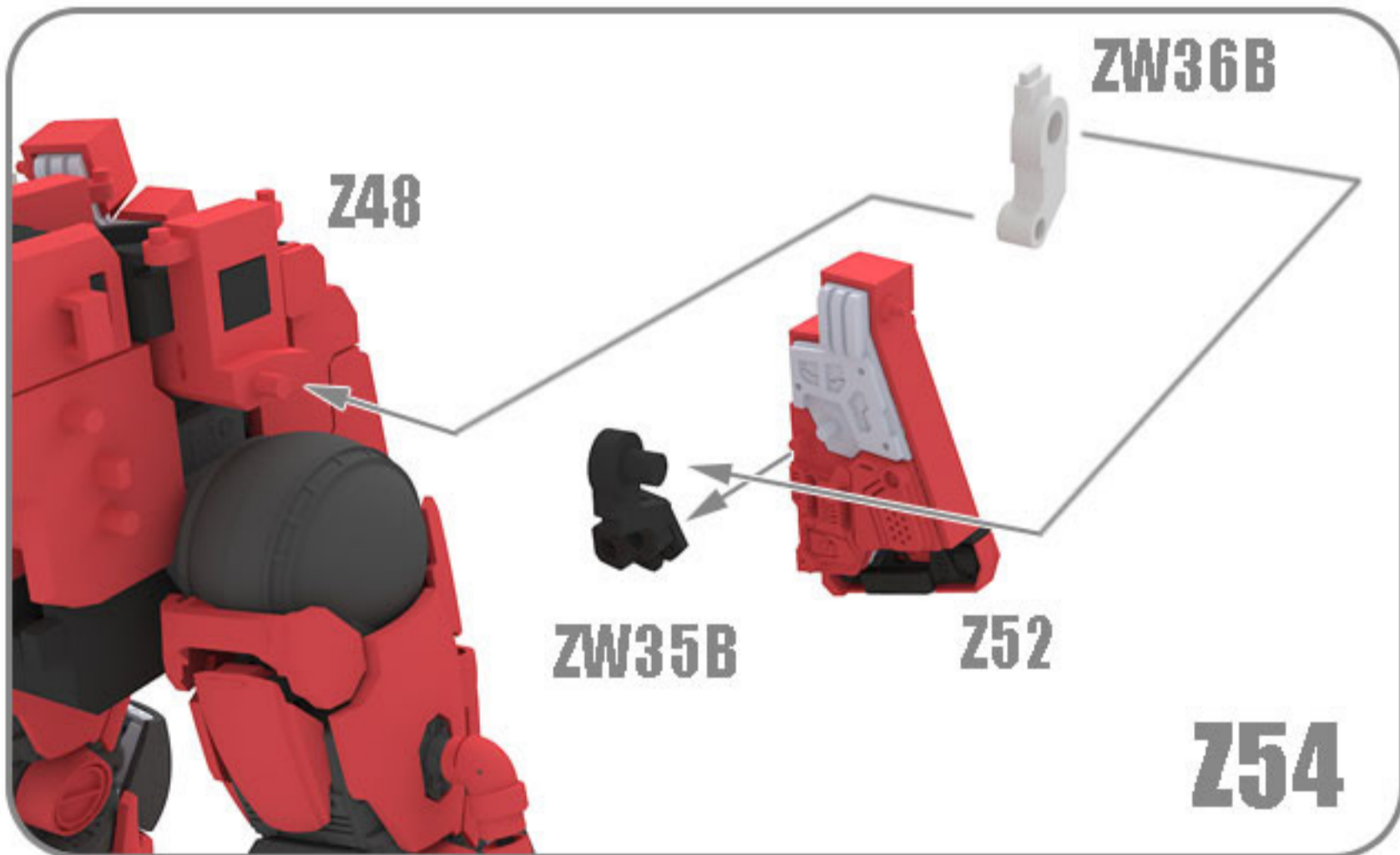
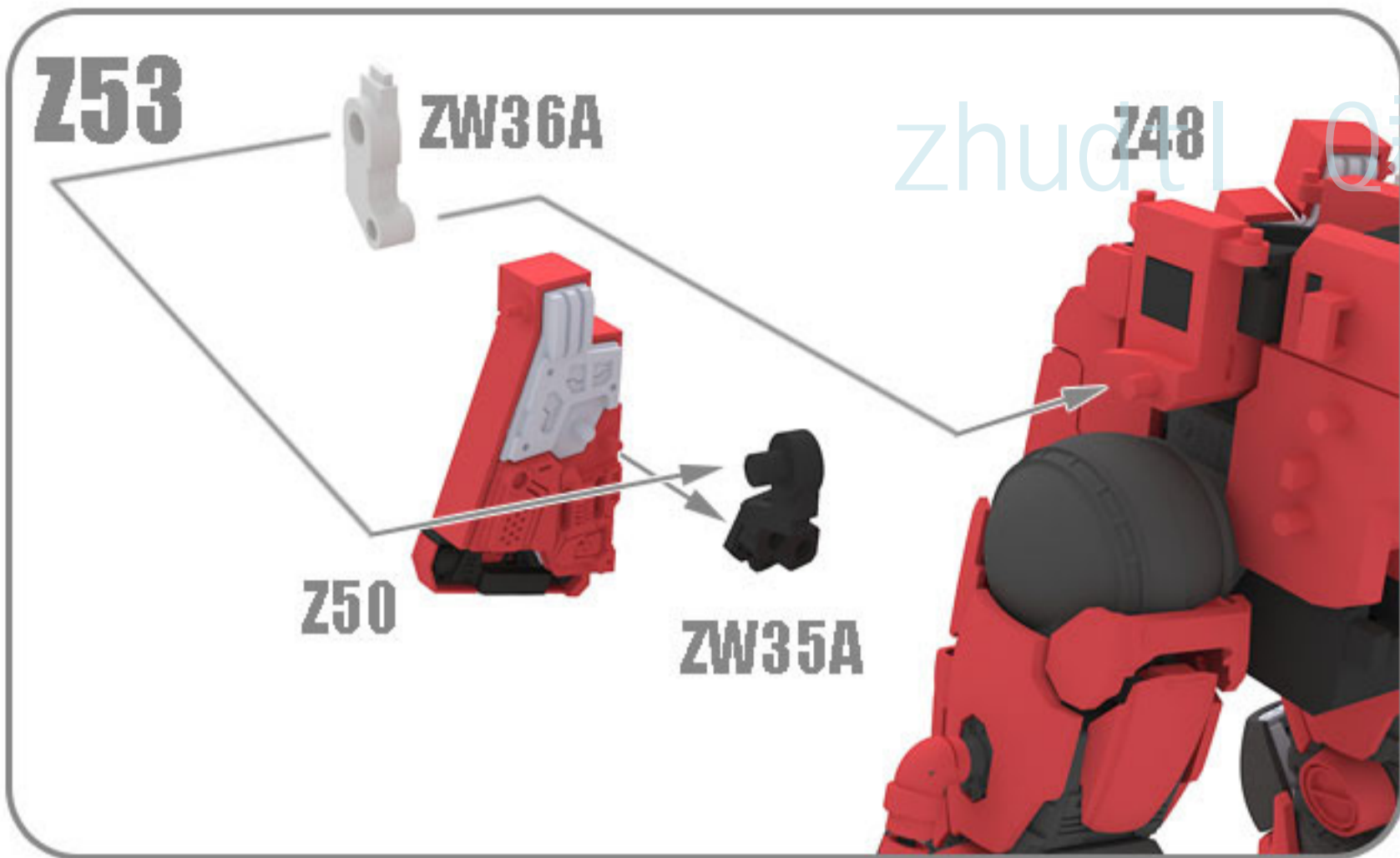

zhudl Q1#777806339 Q2#74415123

DESIGN AND CREATED BY KAIEI3D 2023

2023 年由KAIEI3D 设计与建模

PLEASE RESPECT TO THE DESIGNER EFFORT DO NOT STEAL DESIGN

请尊重设计师，切勿偷盗别人的设计

WARNING : Pirate pictures must be investigated 盗图必究

KAIEI3D

TOYS · GADGET · HOBBY

06
MS06 ZAKU-II

3D PRINT 1:20

BUST ADD-ON Ver.

Z56

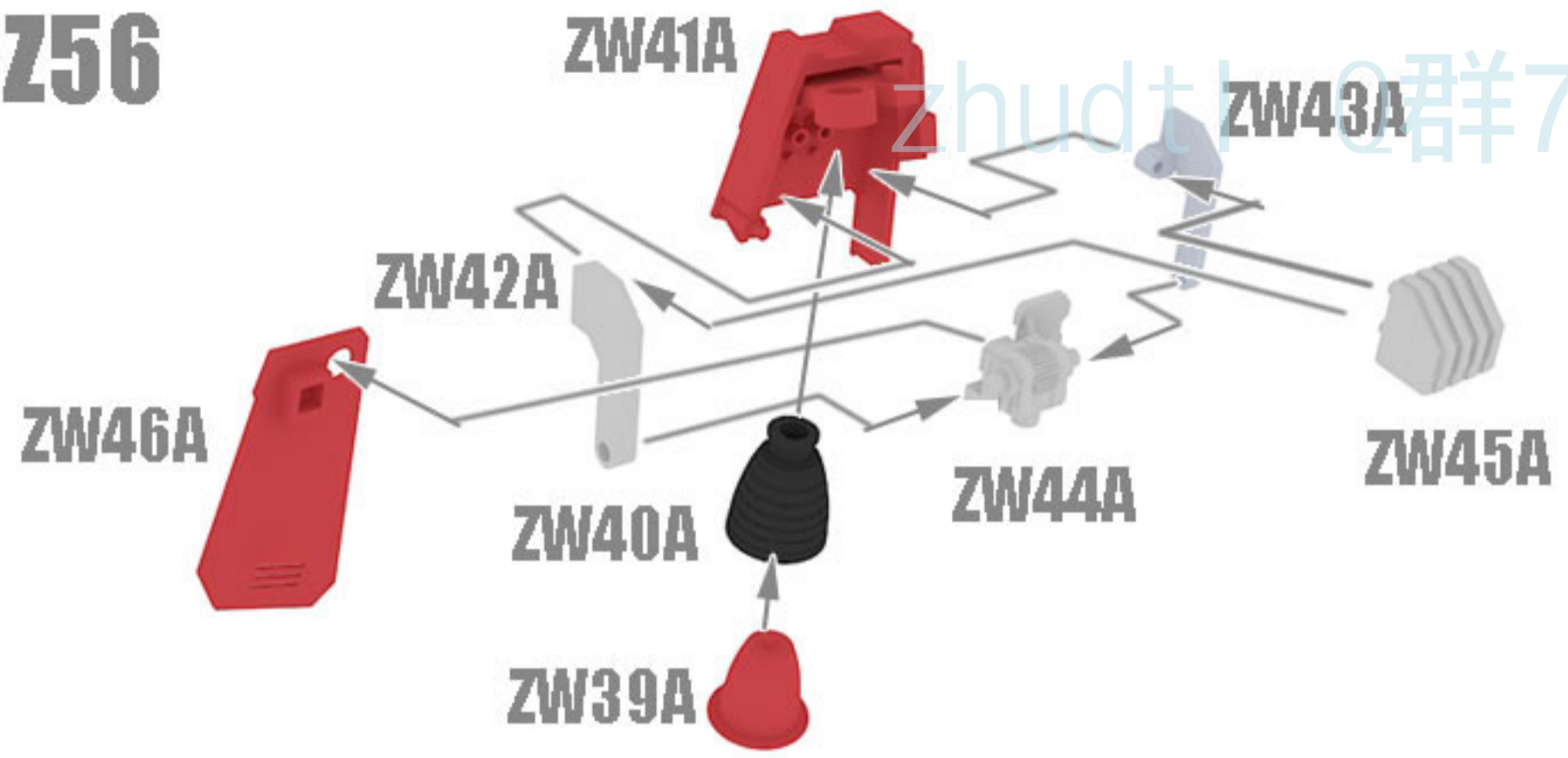

Z58

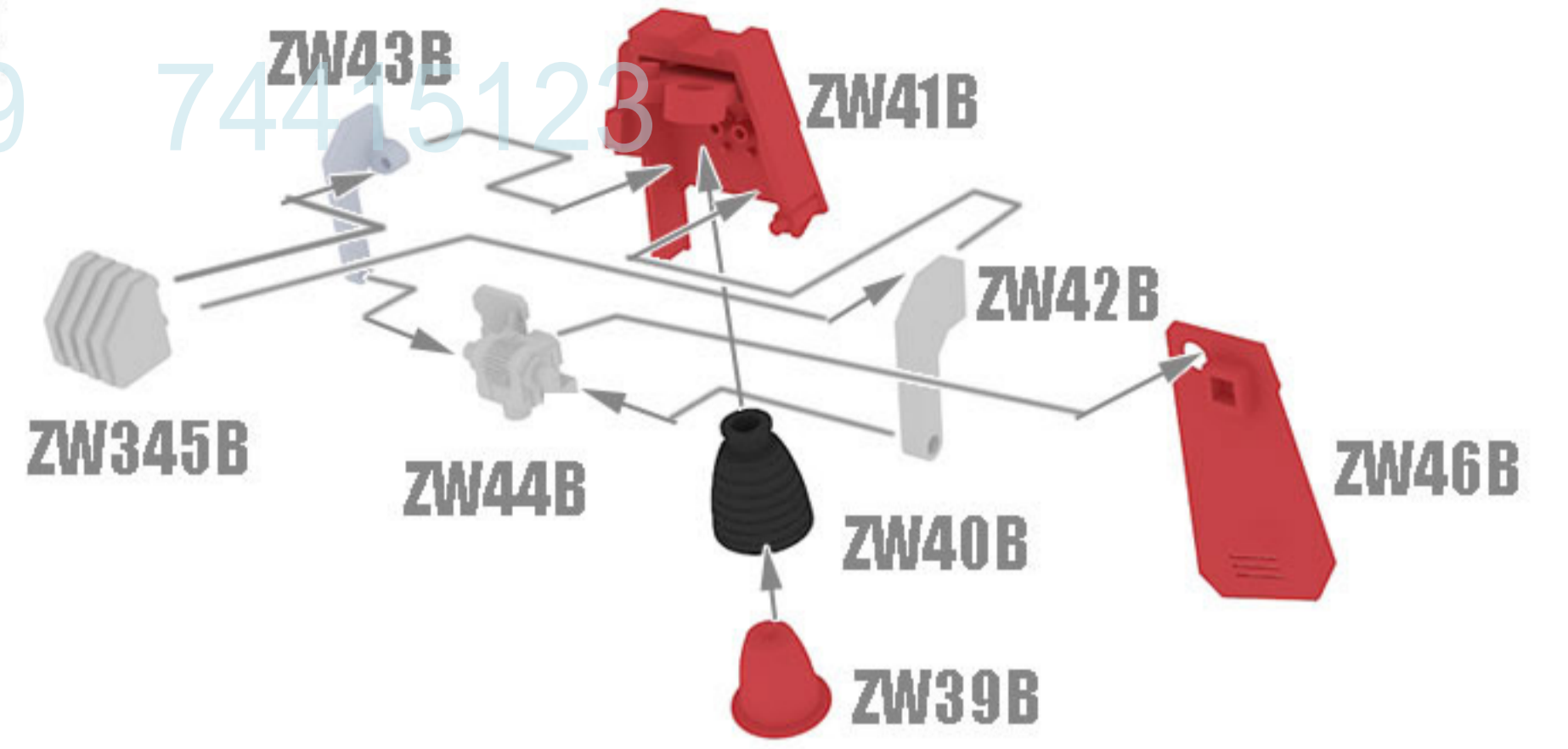

Z57

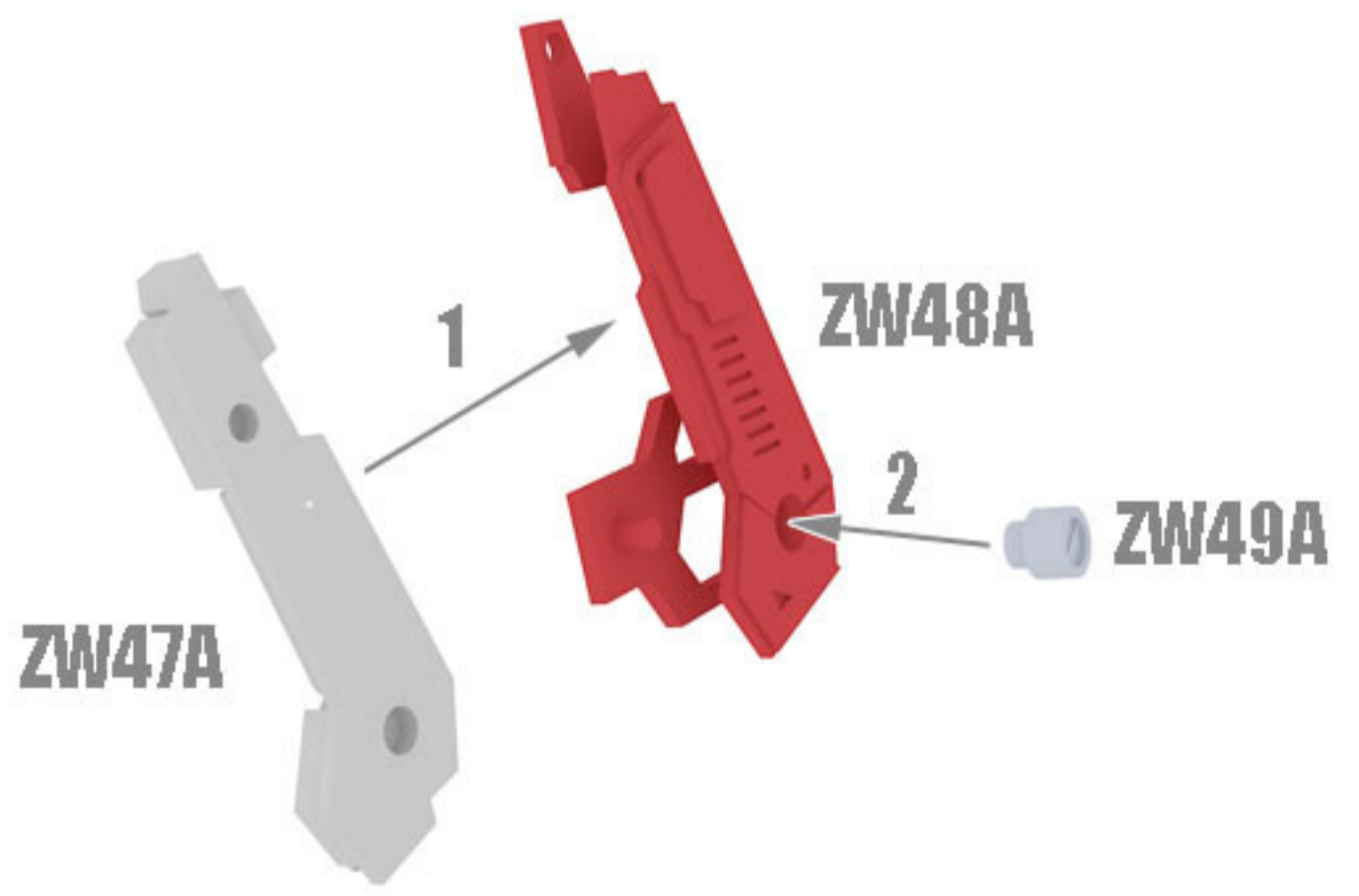

Z59

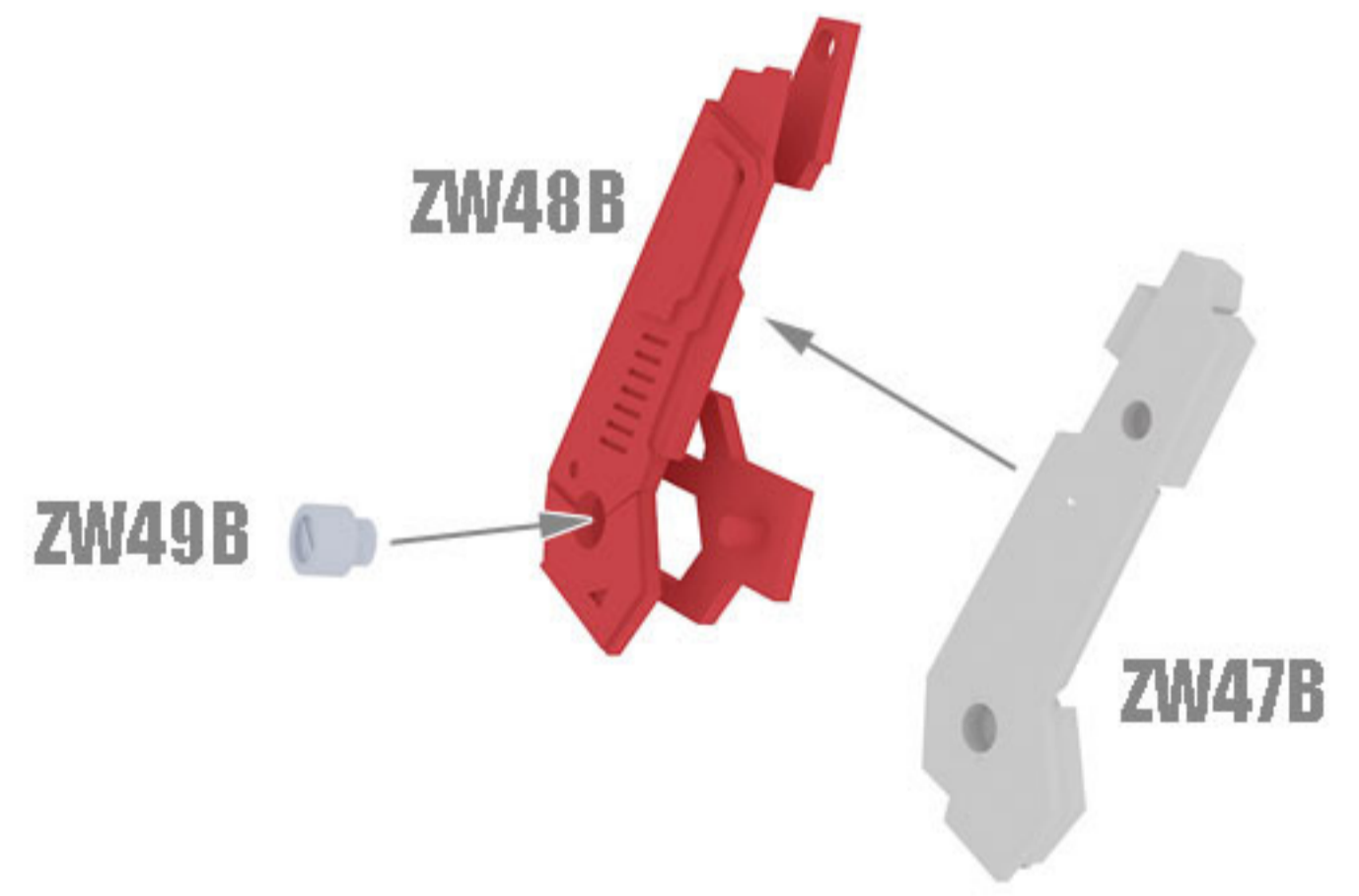

DESIGN AND CREATED BY KAIEI3D 2023
 2023 年由KAIEI3D 设计与建模
 PLEASE RESPECT TO THE DESIGNER EFFORT DO NOT STEAL DESIGN
 请尊重设计师，切勿偷盗别人的设计
 WARNING : Pirate pictures must be investigated 盗图必究



3D PRINT 1:20
BUST ADD-ON Ver.

zhudtl Q群777806339 74415123

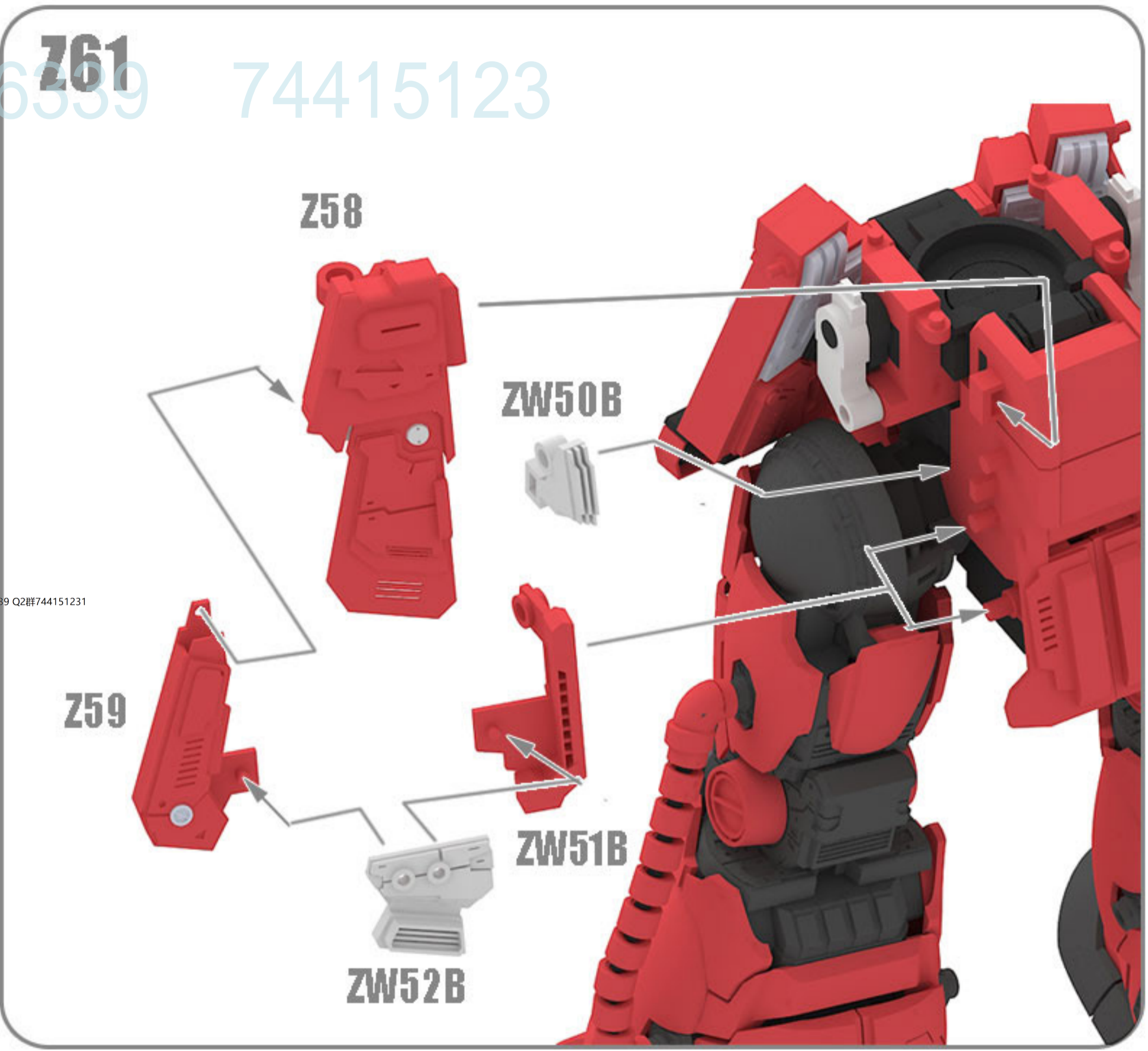
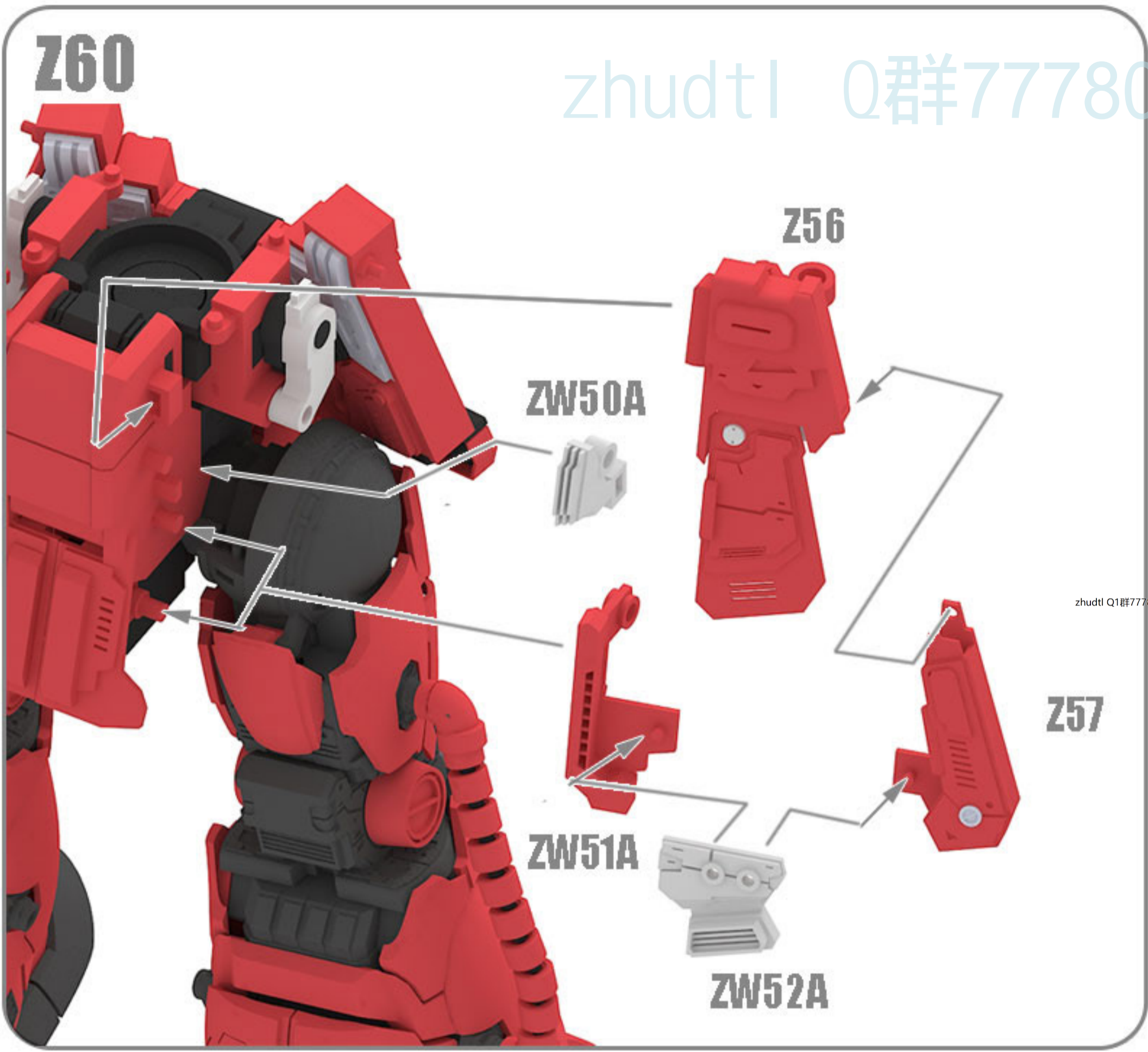

zhudtl Q1群777806339 Q2群744151231

DESIGN AND CREATED BY KAIEI3D 2023
 2023 年 由KAIEI3D 设计与建模
 PLEASE RESPECT TO THE DESIGNER EFFORT DO NOT STEAL DESIGN
 请尊重设计师，切勿偷盗别人的设计
 WARNING : Pirate pictures must be investigated 盗图必究



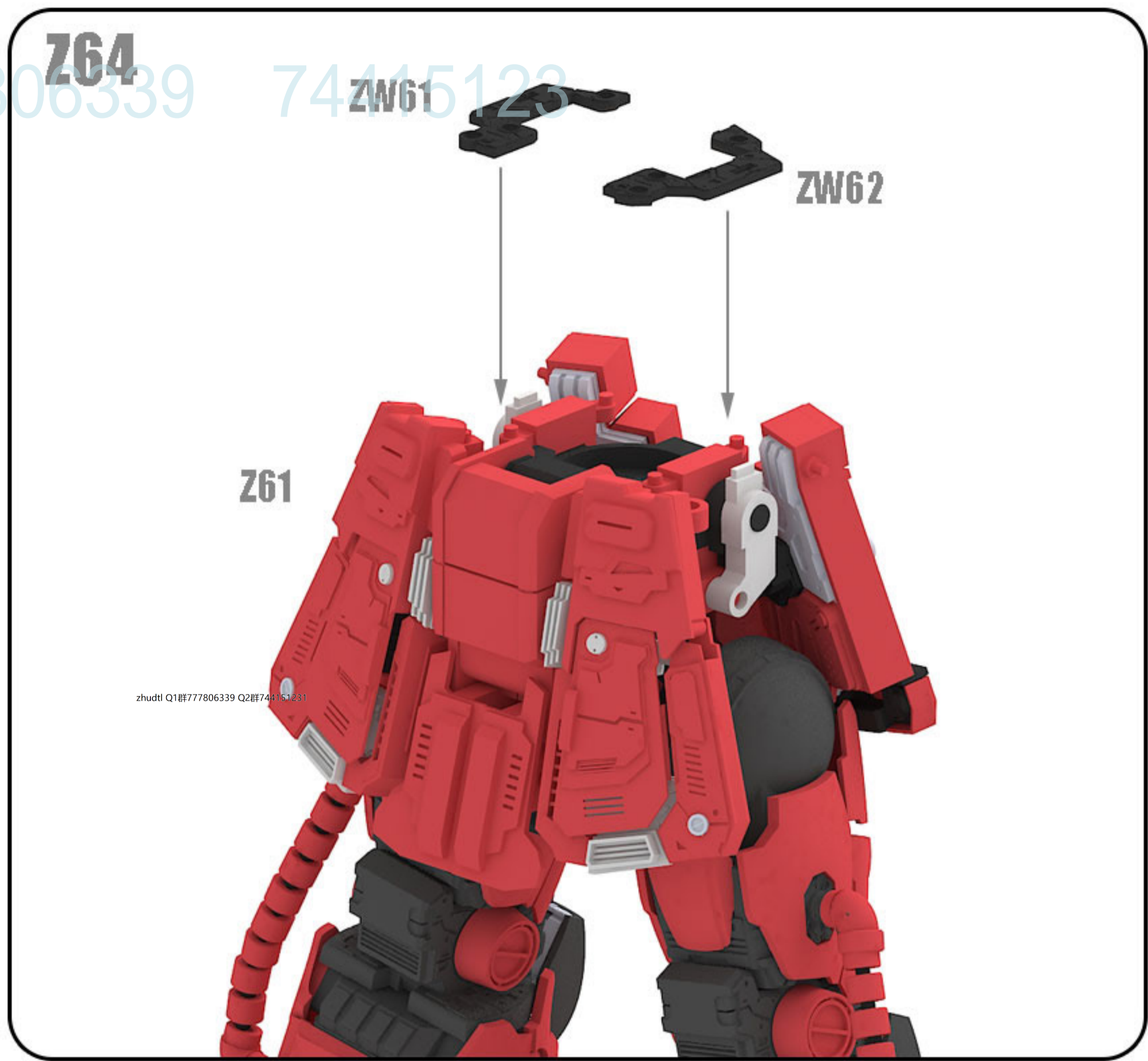
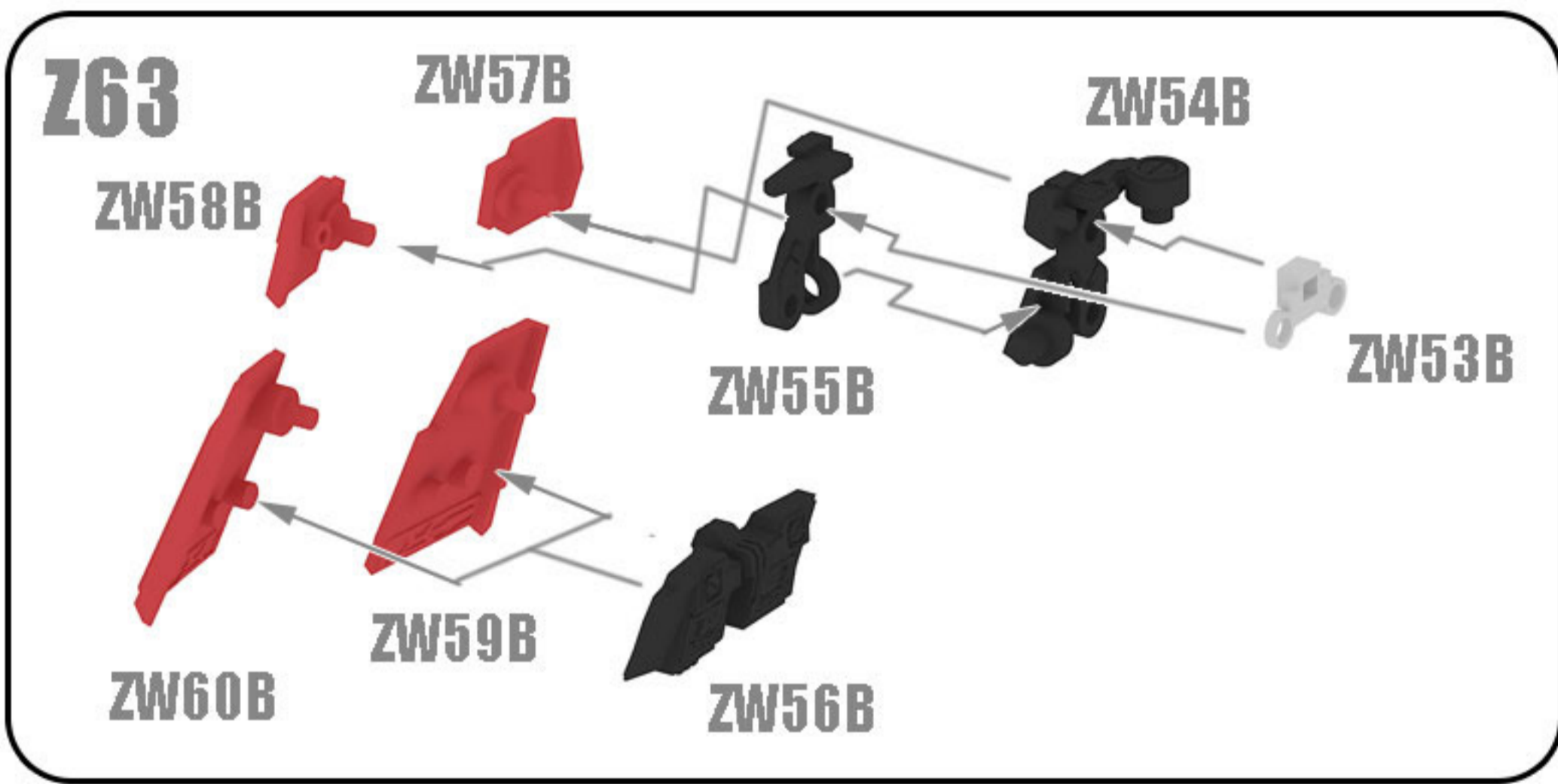
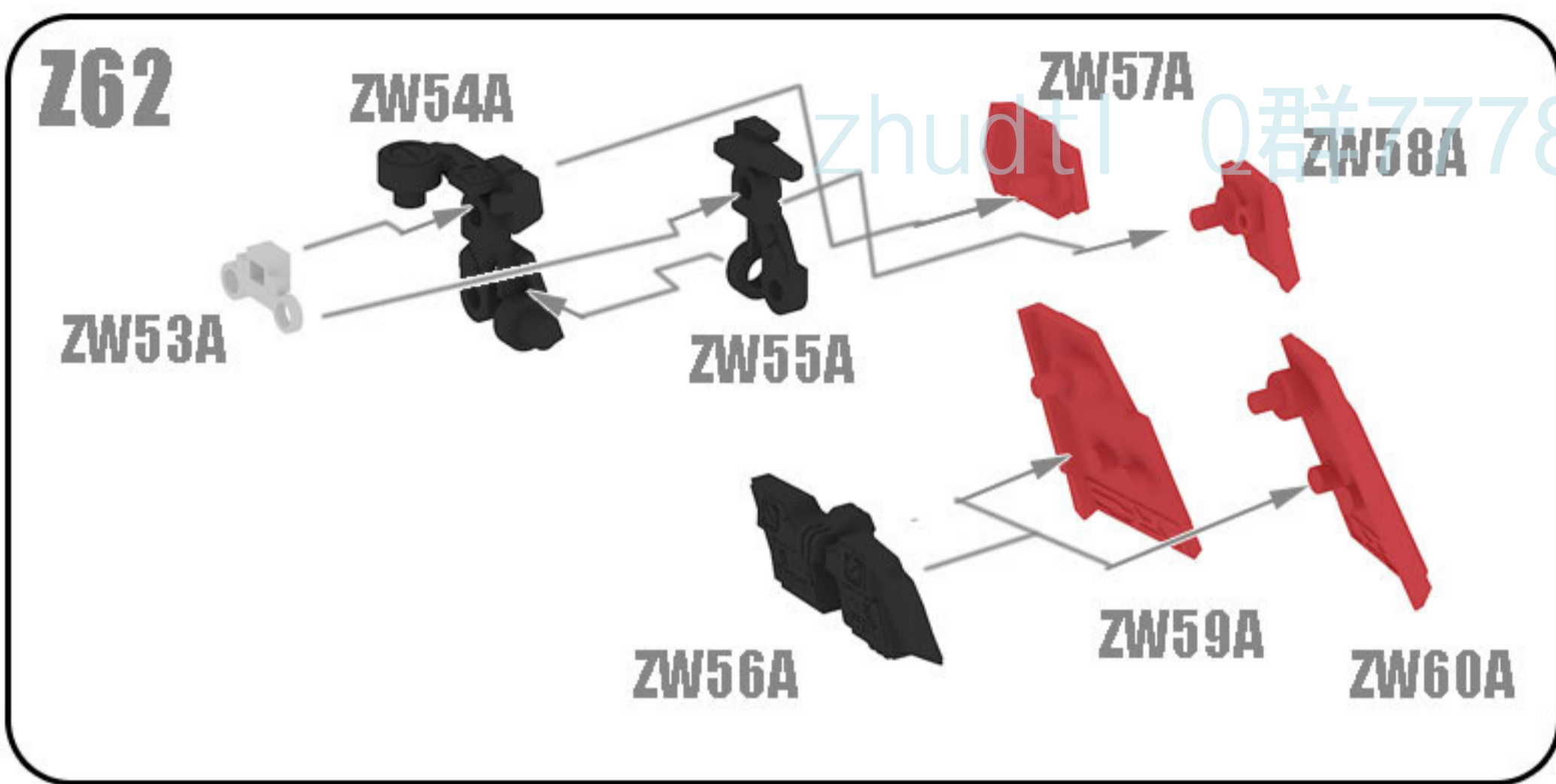

DESIGN AND CREATED BY KAIEI3D 2023
 2023 年由KAIEI3D 设计与建模
 PLEASE RESPECT TO THE DESIGNER EFFORT DO NOT STEAL DESIGN
 请尊重设计师，切勿偷盗别人的设计
 WARNING : Pirate pictures must be investigated 盗图必究



Z65



Z66

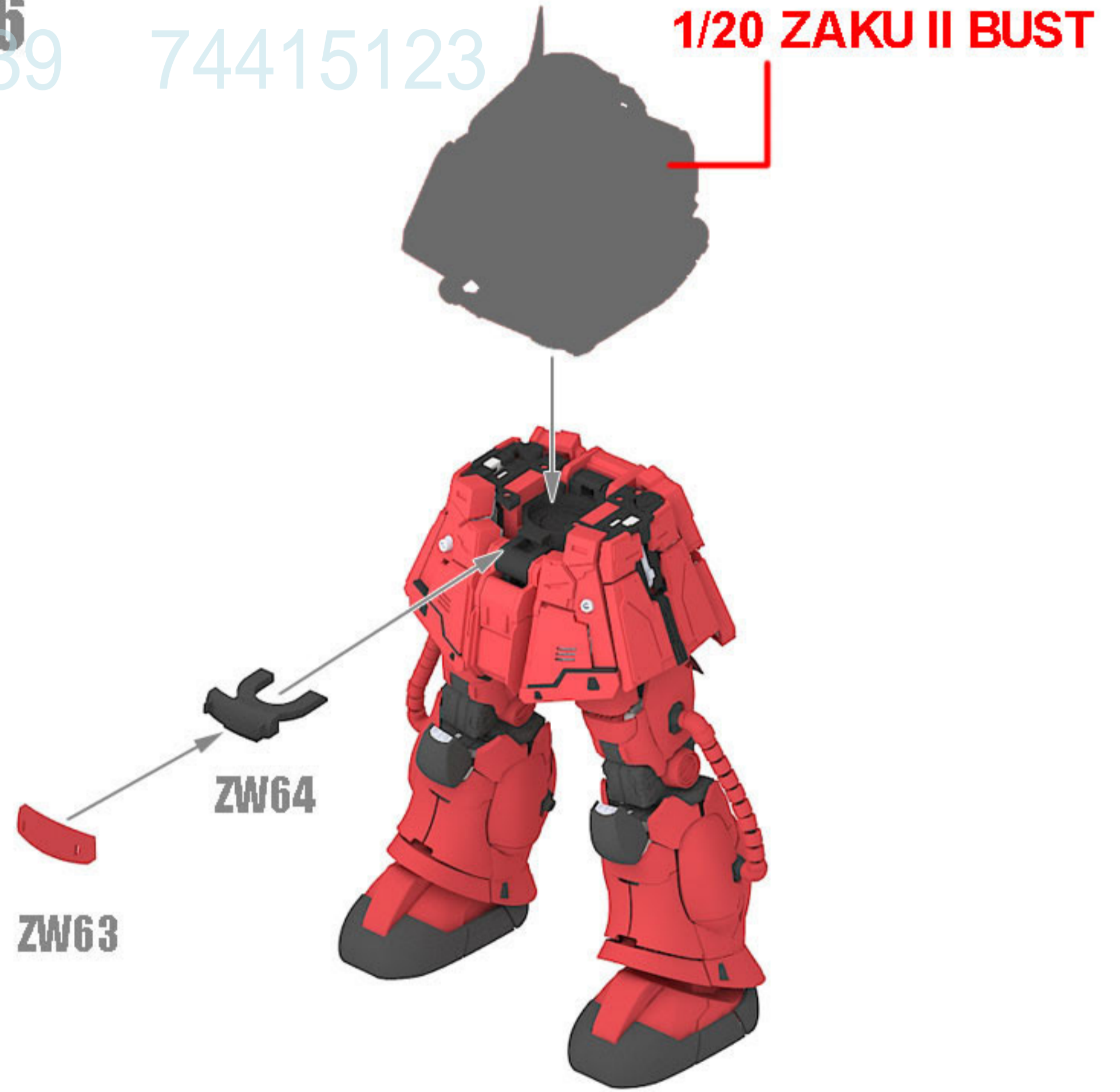

DESIGN AND CREATED BY KAIEI3D 2023

2023 年由KAIEI3D 设计与建模

PLEASE RESPECT TO THE DESIGNER EFFORT DO NOT STEAL DESIGN

请尊重设计师，切勿偷盗别人的设计

WARNING : Pirate pictures must be investigated 盗图必究

KAIEI3D

TOYS · GADGET · HOBBY

06

MS06 ZAKU-II

3D PRINT 1:20

BUST ADD-ON Ver.

Z66x4

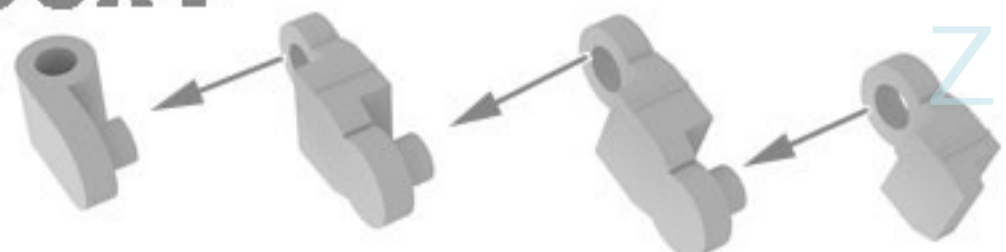

ZAL01/
ZAR01 ZAL02/
ZAR02 ZAL03/
ZAR03 ZAL04/
ZAR04

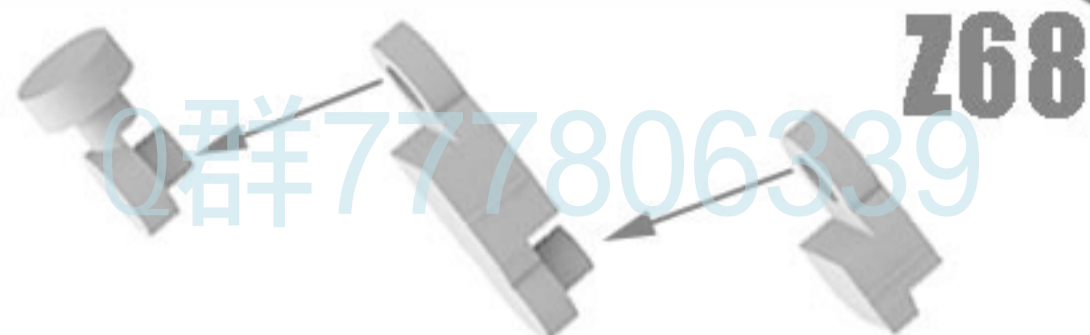

Z68

ZAL08/
ZAR08 ZAL09/
ZAR09 ZAL10/
ZAR10

Z70

ZAL15/
ZAR15



Z69

ZAL16/
ZAR16



Z67

ZAL17/
ZAR17

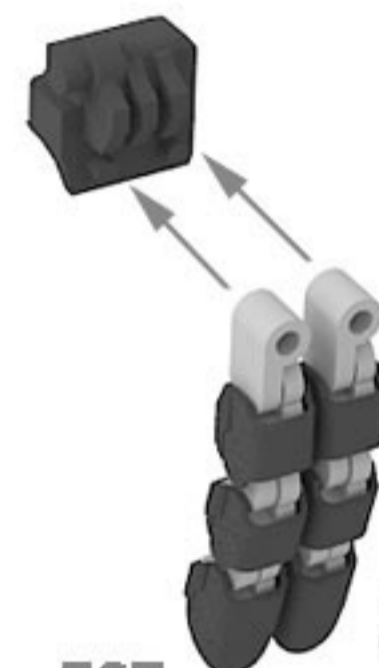

Z67

Z67

Z67

Z67x4



Z66

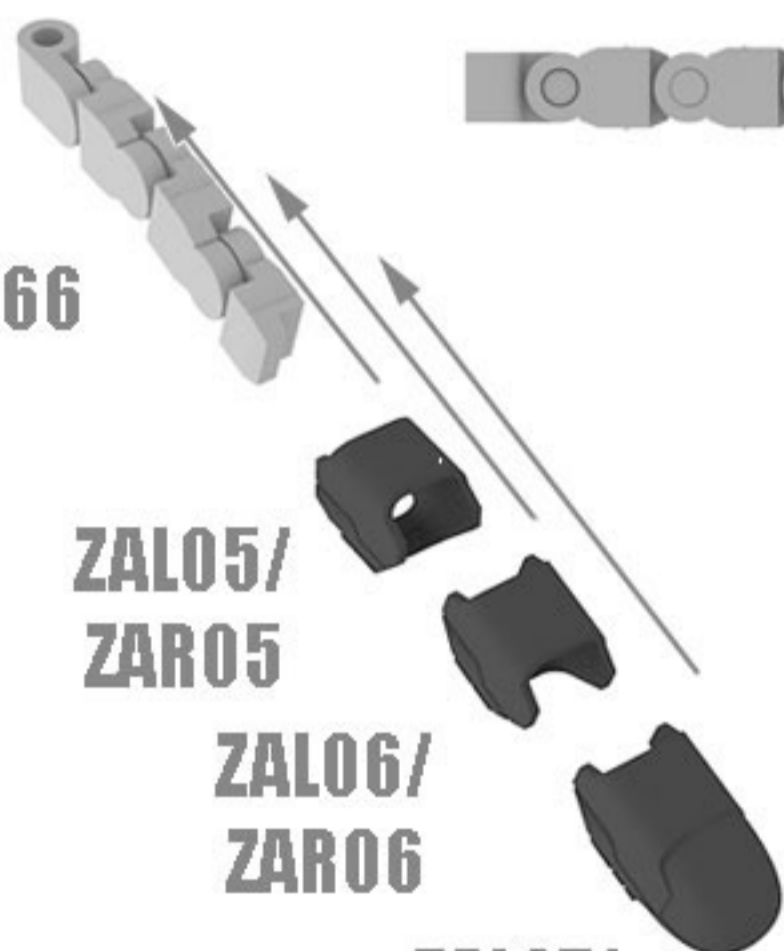

ZAL05/
ZAR05

ZAL06/
ZAR06

ZAL07/
ZAR07

Z69



ZAL11/
ZAR11

ZAL12/
ZAR12

Z68

ZAL13/
ZAR13

ZAL14/
ZAR14

DESIGN AND CREATED BY KAIEI3D 2023

2023 年由KAIEI3D 设计与建模

PLEASE RESPECT TO THE DESIGNER EFFORT DO NOT STEAL DESIGN

请尊重设计师，切勿偷盗别人的设计

WARNING : Pirate pictures must be investigated 盗图必究



TOYS · GADGET · HOBBY



3D PRINT 1:20

BUST ADD-ON Ver.

Z71

ZAL18/
ZAR18

zhudtI

Z73

06 777806339

Z74

74415123

Z70

ZAL19/
ZAR19

Z70

Z70

ZAL22/
ZAR22

ZAL23/
ZAR23

ZAL26/
ZAR26

ZAL24/
ZAR24

ZAL25/
ZAR25

Z73

ZAL27/
ZAR27

Z72

ZAL20/
ZAR20

Z71

ZAL21/
ZAR21

Z72

DESIGN AND CREATED BY KAIEI3D 2023

2023 年由KAIEI3D 设计与建模

PLEASE RESPECT TO THE DESIGNER EFFORT DO NOT STEAL DESIGN

请尊重设计师，切勿偷盗别人的设计

WARNING : Pirate pictures must be investigated 盗图必究



TOYS · GADGET · HOBBY



3D PRINT 1:20

BUST ADD-ON Ver.

Z15

ZAL28/
ZAR28

ZAL31/
ZAR31

ZAL32/
ZAR32

ZAL33/
ZAR33

ZAL34/
ZAR34

ZAL30/
ZAR30

ZAL29/
ZAR29

Z14

Z16

ZAL35/
ZAR35

ZAL36/
ZAR36

ZAL38/
ZAR38

ZAL40/
ZAR40

Z15

ZAL37/
ZAR37

ZAL39/
ZAR39

ZAL41/
ZAR41

Z17

ZAL42/
ZAR42

ZAL44/
ZAR44

ZAL43/
ZAR43

ZAL45/
ZAR45

Z16

DESIGN AND CREATED BY KAIEI3D 2023

2023 年 由KAIEI3D 设计与建模

PLEASE RESPECT TO THE DESIGNER EFFORT DO NOT STEAL DESIGN

请尊重设计师，切勿偷盗别人的设计

WARNING : Pirate pictures must be investigated 盗图必究

KAIEI3D

TOYS · GADGET · HOBBY

06
MS06 ZAKU-II

3D PRINT 1:20

BUST ADD-ON Ver.

Z78

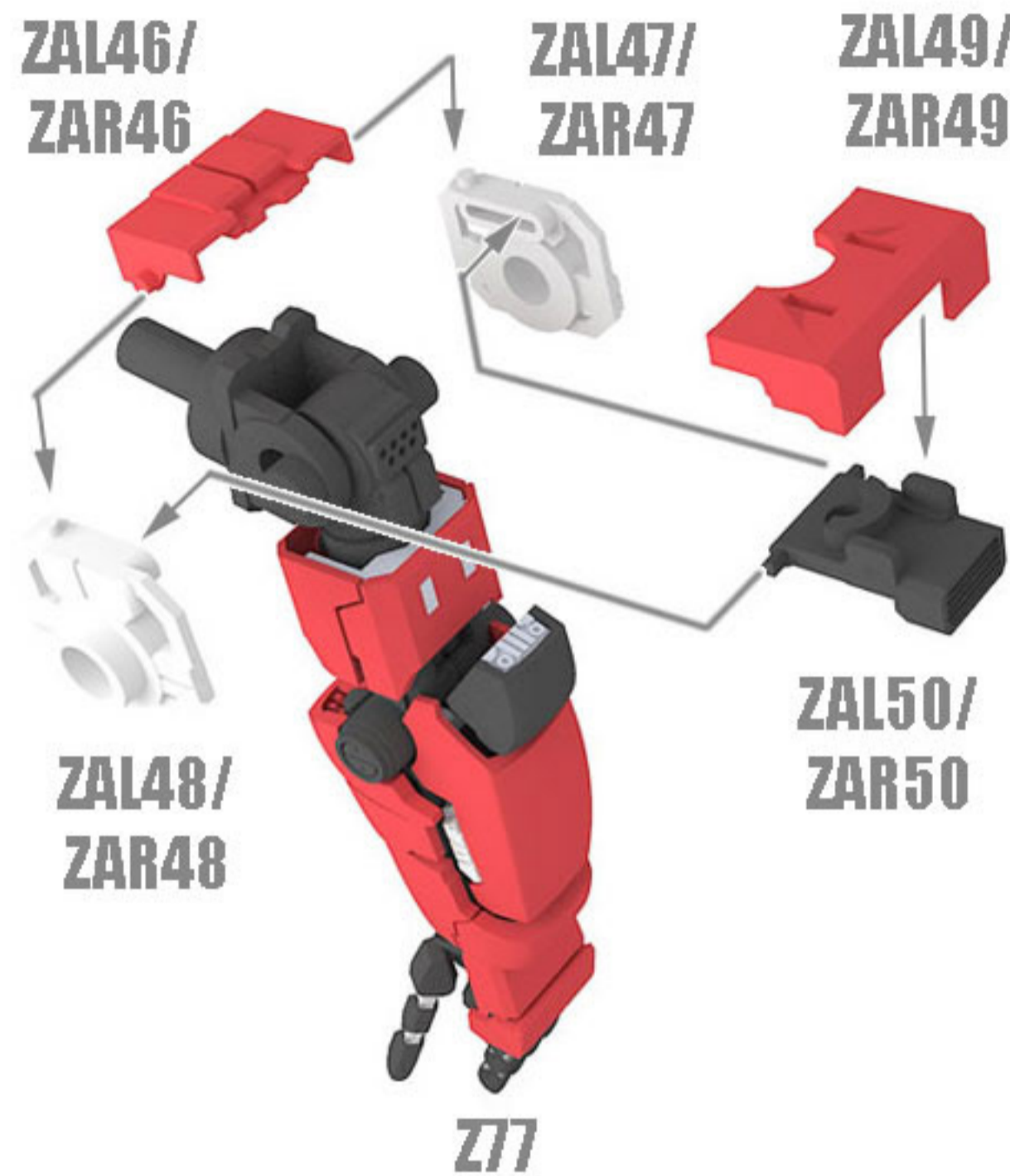

Z79



zhudtl Q群777806339 74415123

DESIGN AND CREATED BY KAIEI3D 2023

2023 年由KAIEI3D 设计与建模

PLEASE RESPECT TO THE DESIGNER EFFORT DO NOT STEAL DESIGN

请尊重设计师，切勿偷盗别人的设计

WARNING : Pirate pictures must be investigated 盗图必究



3D PRINT 1:20

BUST ADD-ON Ver.

Z80

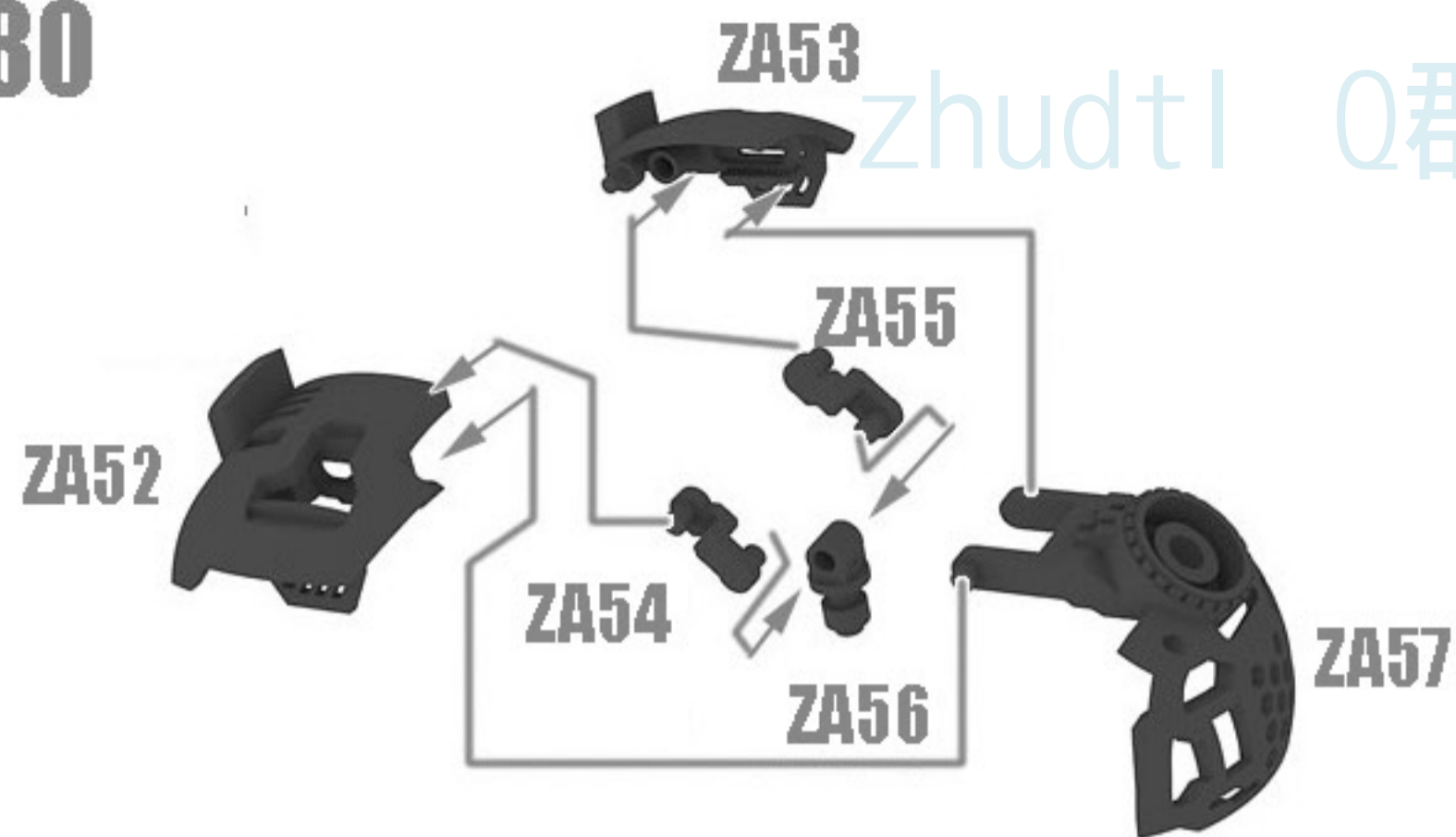

Z82

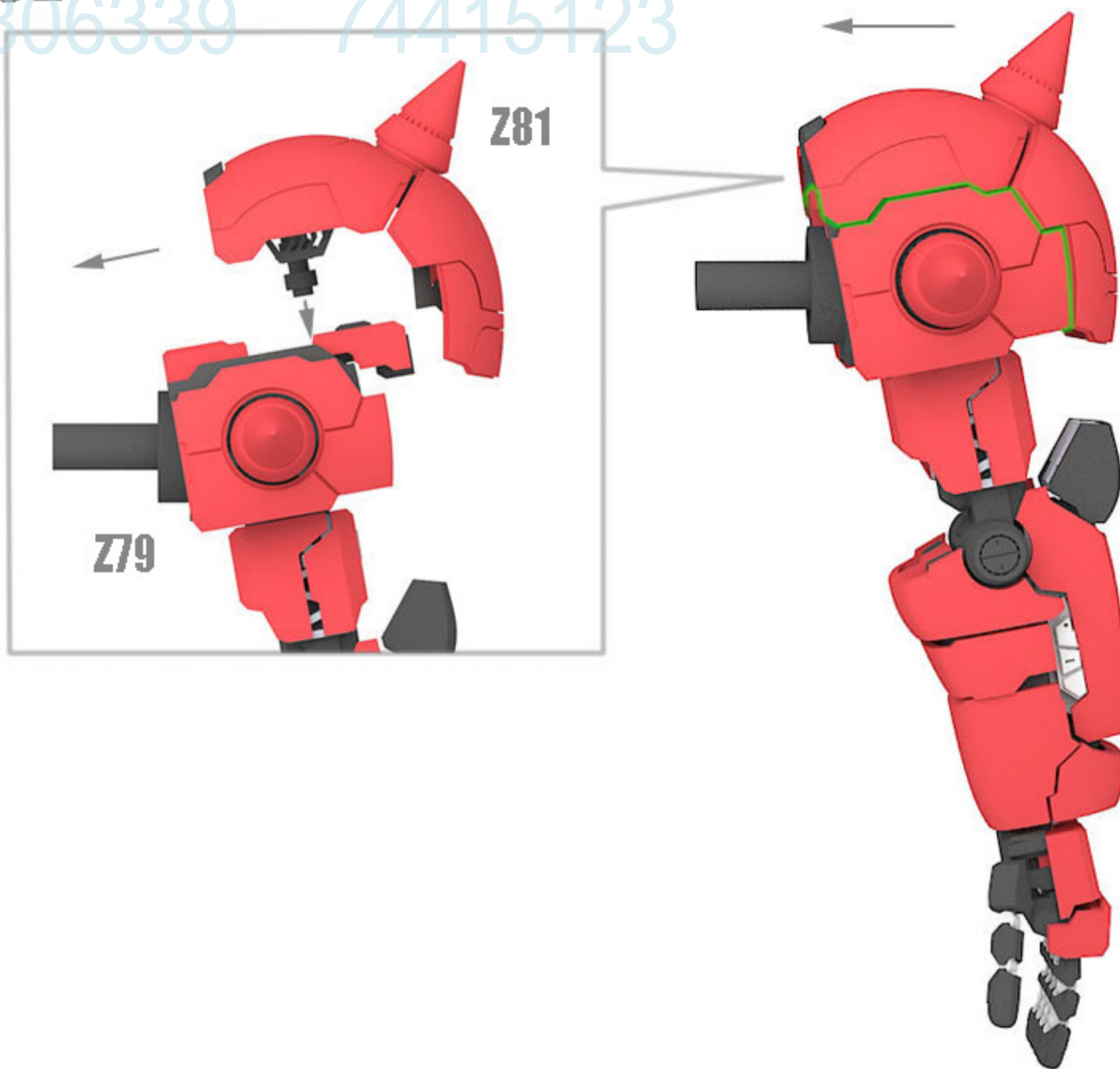

Z81



DESIGN AND CREATED BY KAIEI3D 2023

2023 年由KAIEI3D 设计与建模

PLEASE RESPECT TO THE DESIGNER EFFORT DO NOT STEAL DESIGN

请尊重设计师，切勿偷盗别人的设计

WARNING : Pirate pictures must be investigated 盗图必究



TOYS · GADGET · HOBBY



3D PRINT 1:20

BUST ADD-ON Ver.

Z83



ZA61A



ZA61B

zhudtl Q群777806339 74415123

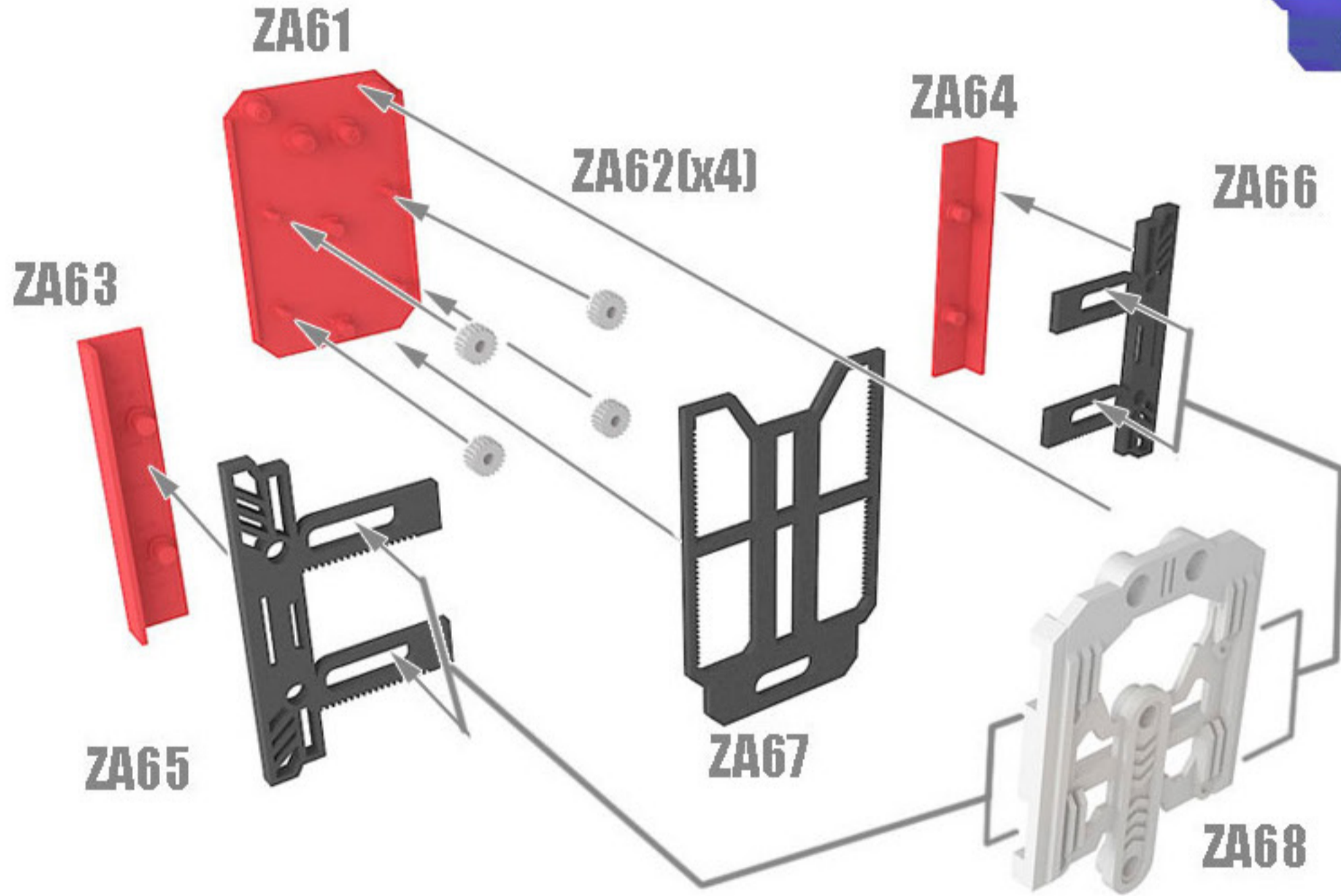
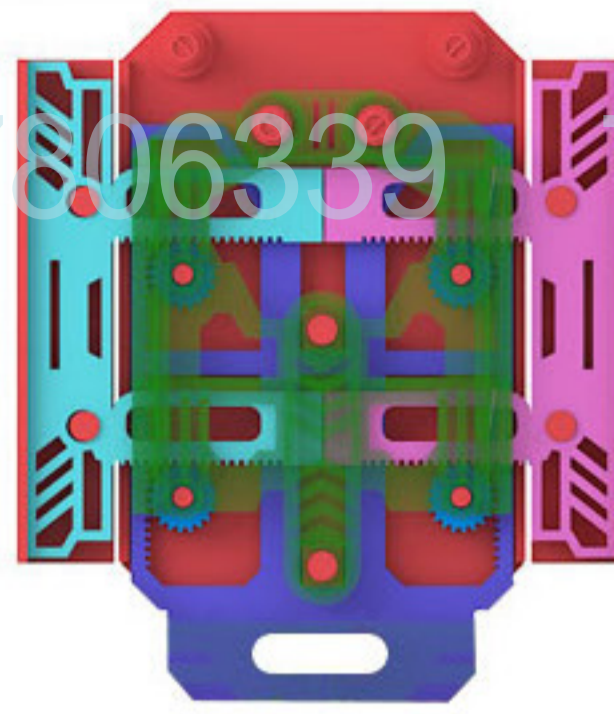

Z84

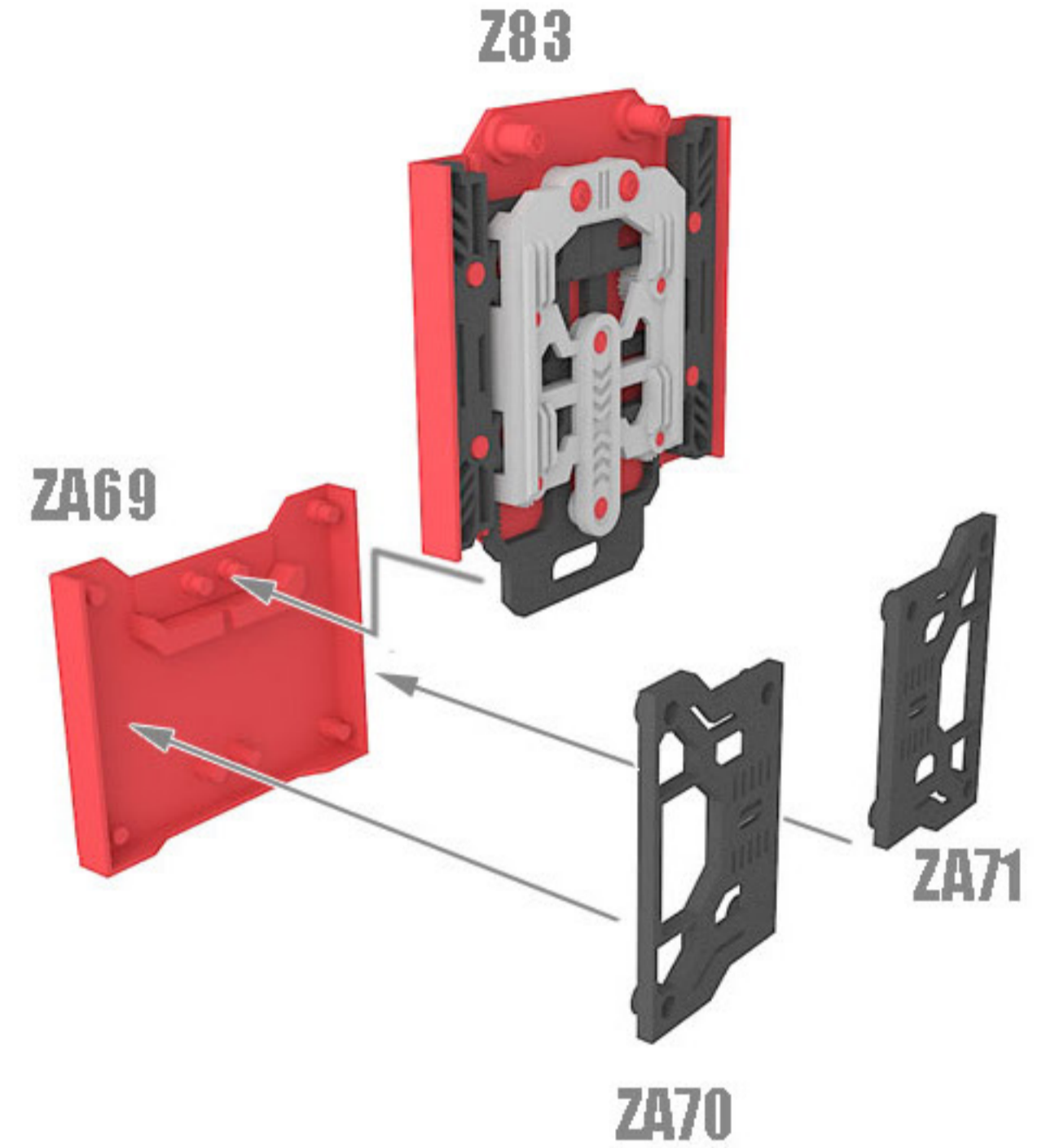

DESIGN AND CREATED BY KAIEI3D 2023

2023 年由KAIEI3D 设计与建模

PLEASE RESPECT TO THE DESIGNER EFFORT DO NOT STEAL DESIGN

请尊重设计师，切勿偷盗别人的设计

WARNING : Pirate pictures must be investigated 盗图必究



TOYS · GADGET · HOBBY



3D PRINT 1:20

BUST ADD-ON Ver.

Z85

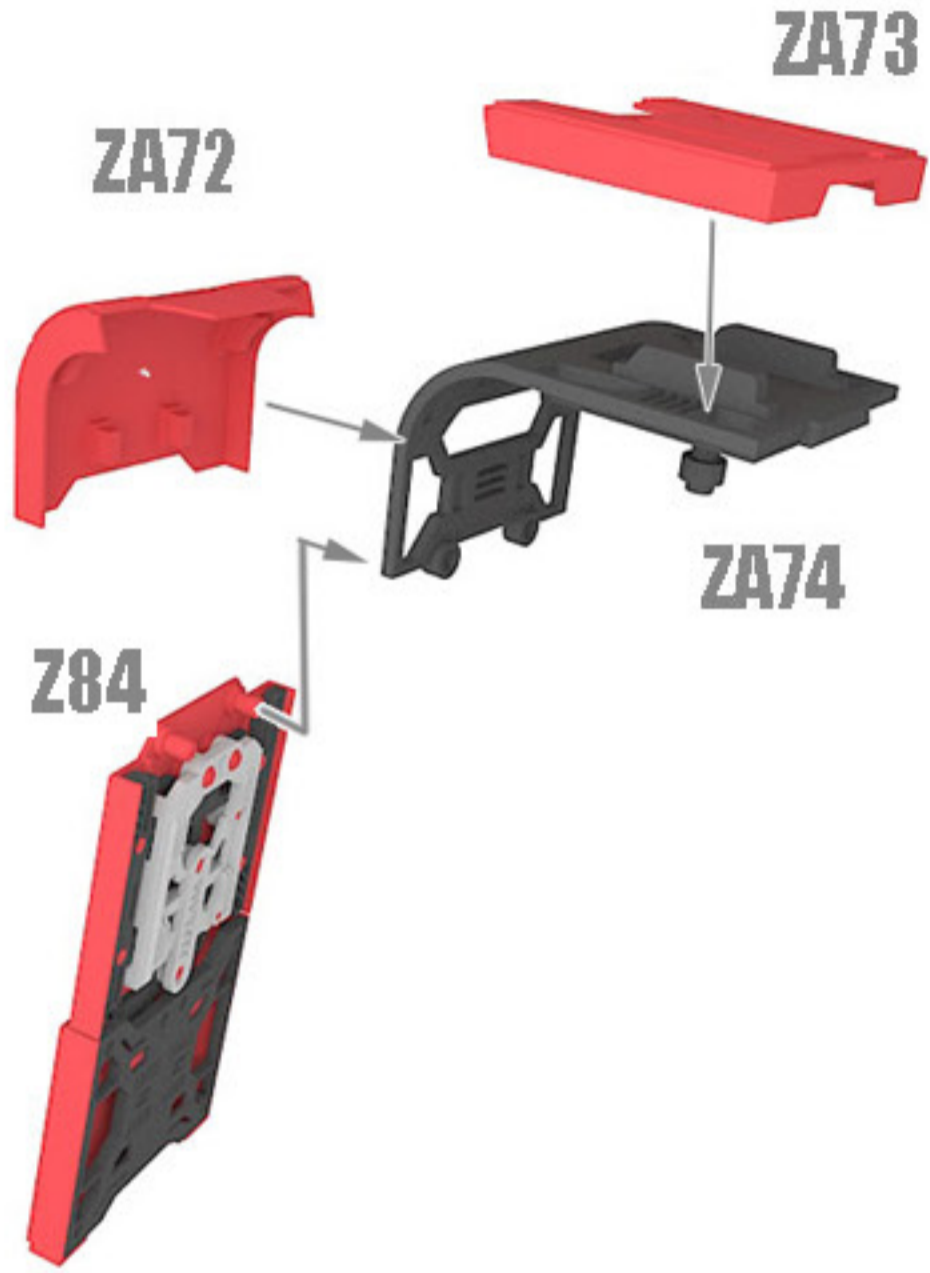

Z86

zhudt | Q群777806339 | 74415123

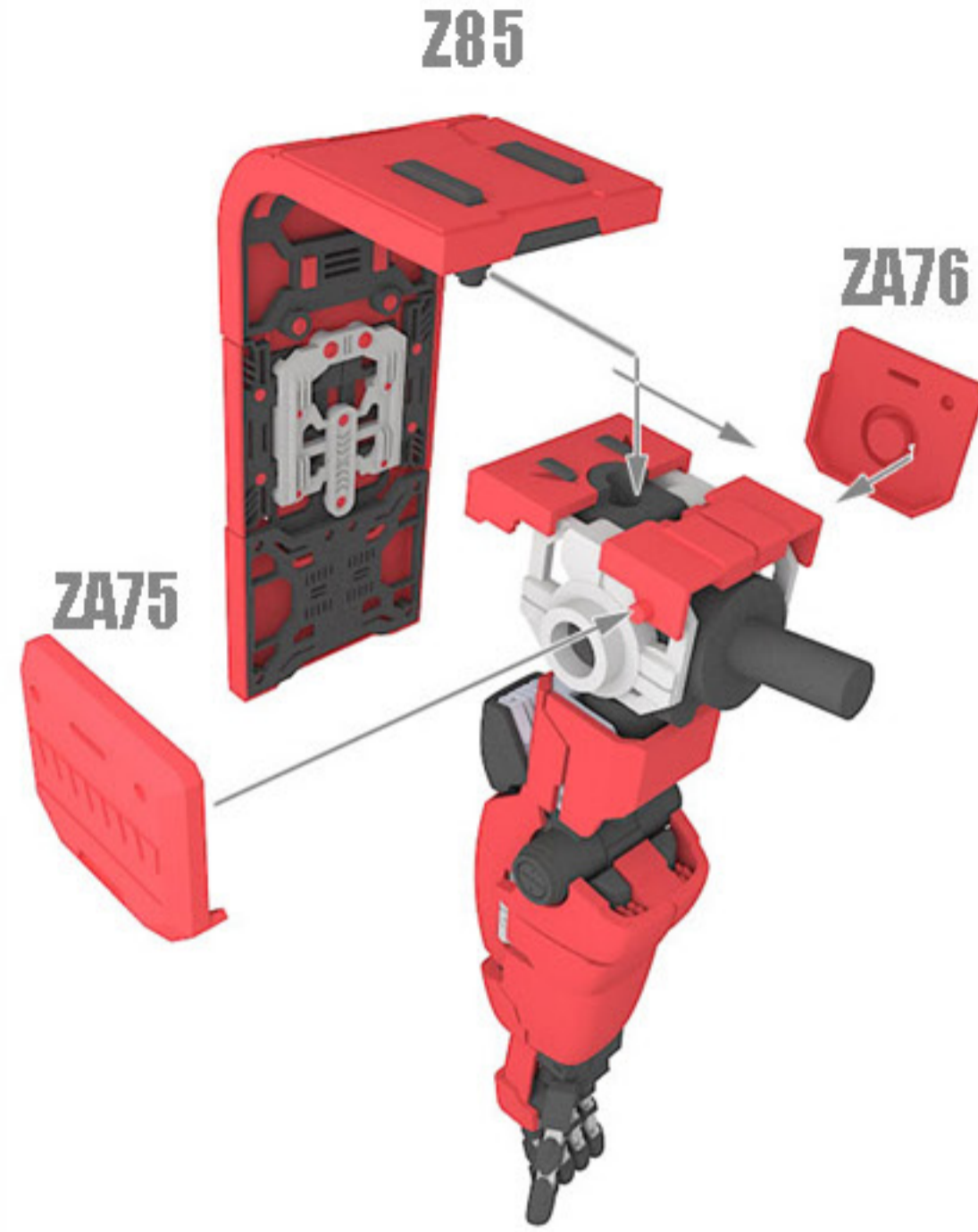

Z87

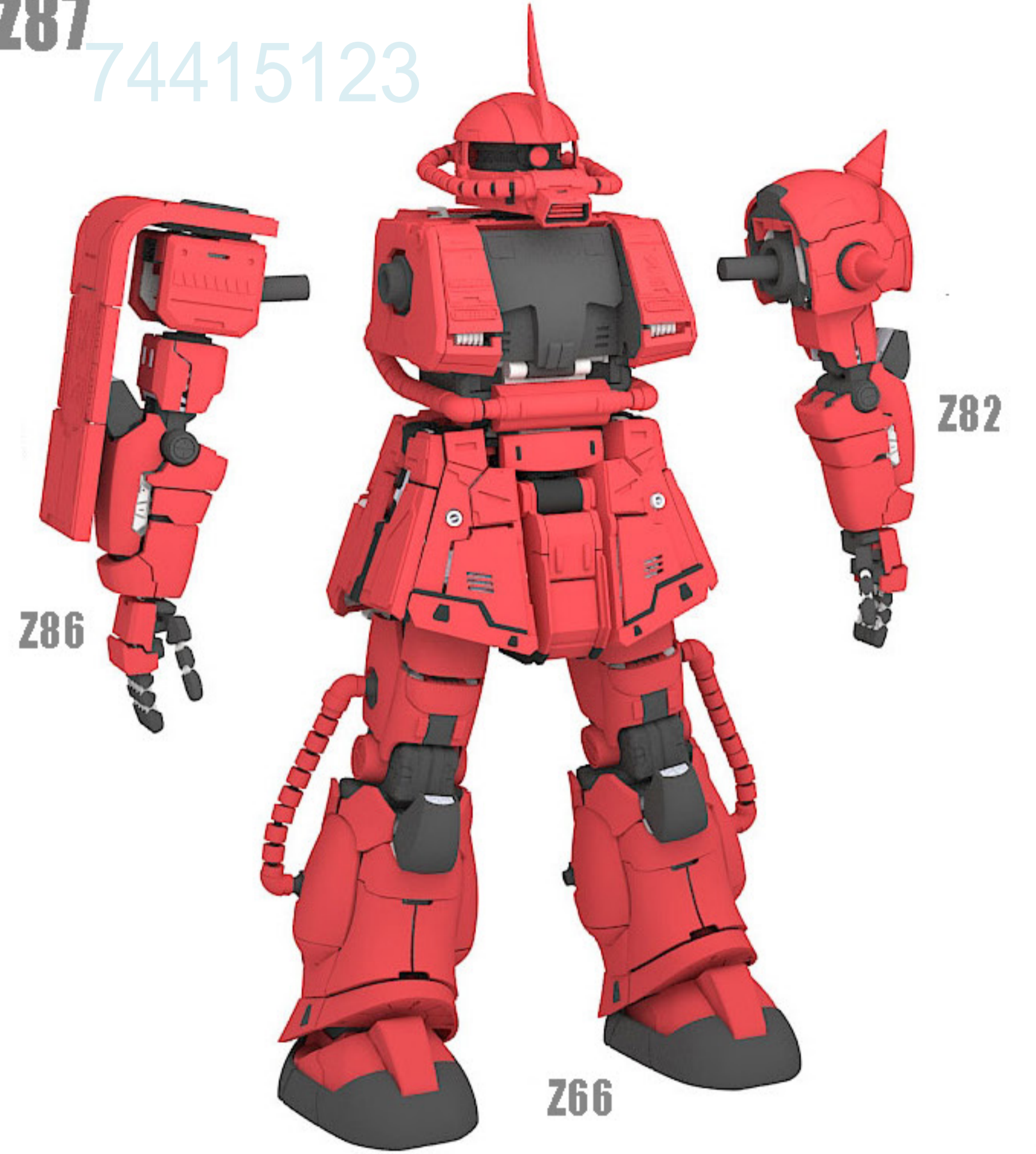

DESIGN AND CREATED BY KAIEI3D 2023

2023 年由KAIEI3D 设计与建模

PLEASE RESPECT TO THE DESIGNER EFFORT DO NOT STEAL DESIGN

请尊重设计师，切勿偷盗别人的设计

WARNING : Pirate pictures must be investigated 盗图必究

KAIEI3D

TOYS · GADGET · HOBBY

06
MS06 ZAKU-II

3D PRINT 1:20

BUST ADD-ON Ver.

COMPLETE

zhudt | Q群777806339 74415123



FRONT



BACK



OPEN HATCH



DESIGN AND CREATED BY KAIEI3D 2023

2023 年由KAIEI3D 设计与建模

PLEASE RESPECT TO THE DESIGNER EFFORT DO NOT STEAL DESIGN

请尊重设计师，切勿偷盗别人的设计

WARNING : Pirate pictures must be investigated 盗图必究



3D PRINT 1:20

BUST ADD-ON Ver.

zhudt | 群777806339 74415123



MS06



MS06S



BLANK SHOULDER



BOTH SHIELD



BOTH SPIKE

DESIGN AND CREATED BY KAIEI3D 2023

2023 年由KAIEI3D 设计与建模

PLEASE RESPECT TO THE DESIGNER EFFORT DO NOT STEAL DESIGN

请尊重设计师，切勿偷盗别人的设计

WARNING : Pirate pictures must be investigated 盗图必究



3D PRINT 1:20

BUST ADD-ON Ver.

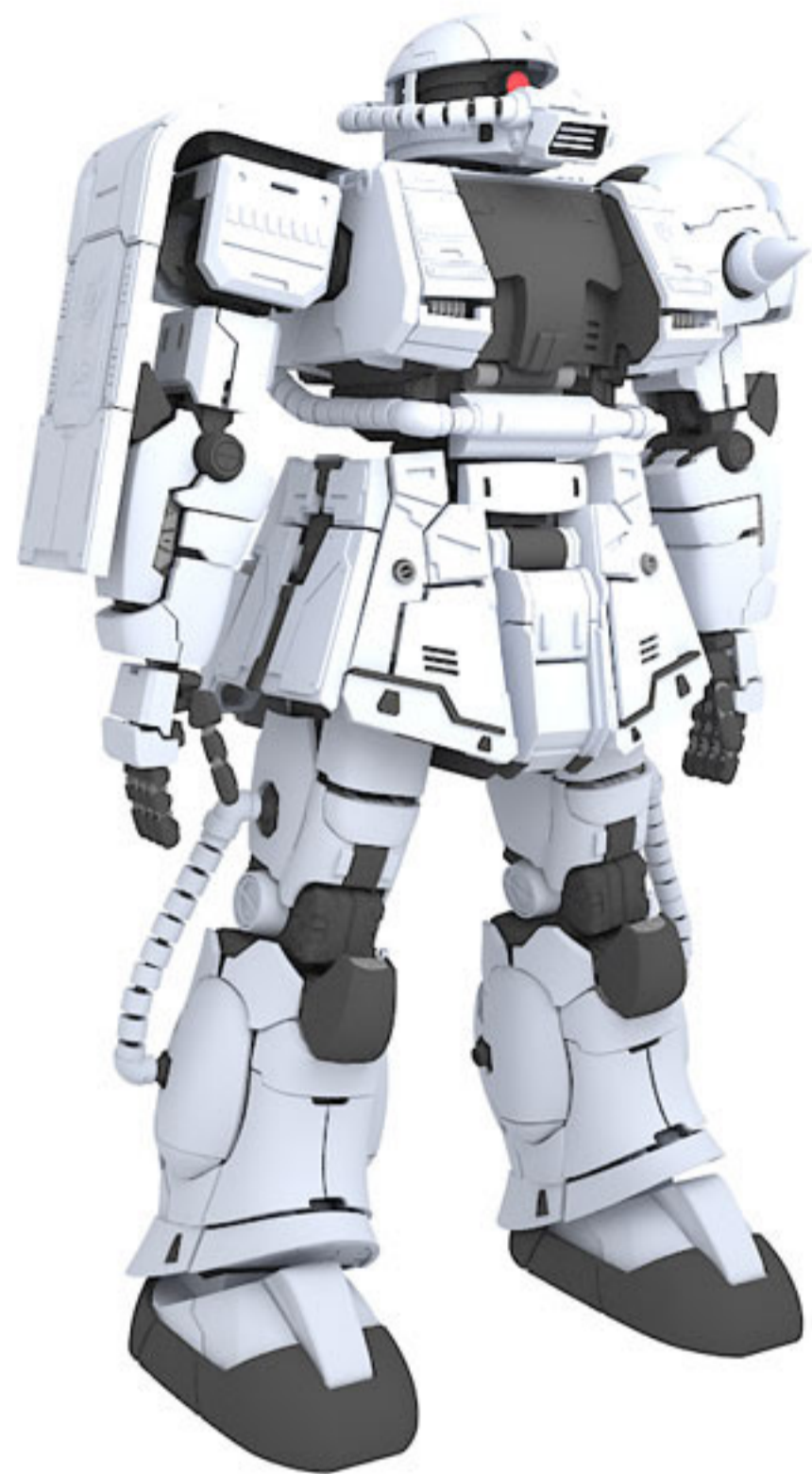

ZA61C



BD28R C



BD07 C

SPECIAL NOTE:

when 3D print 1/20 Zaku II finale youtube video reach above 1000 likes, we will update new parts for this 3D print 1/20 Zaku II. For those who already purchased can enjoy the update part for free. Share and like the video, more "likes" will make more upgrade part will release. Thanks



YouTube

EXTRA TIPS*

print with different color filament combination to create different Zaku unit

DESIGN AND CREATED BY KAIEI3D 2023

2023 年由KAIEI3D 设计与建模

PLEASE RESPECT TO THE DESIGNER EFFORT DO NOT STEAL DESIGN

请尊重设计师，切勿偷盗别人的设计

WARNING : Pirate pictures must be investigated 盗图必究



TOYS - GADGET - HOBBY



3D PRINT 1:20

BUST ADD-ON Ver.