

Titanic

3D printing model

Assembly manual
for **DLP/SLA**

body

3D

1

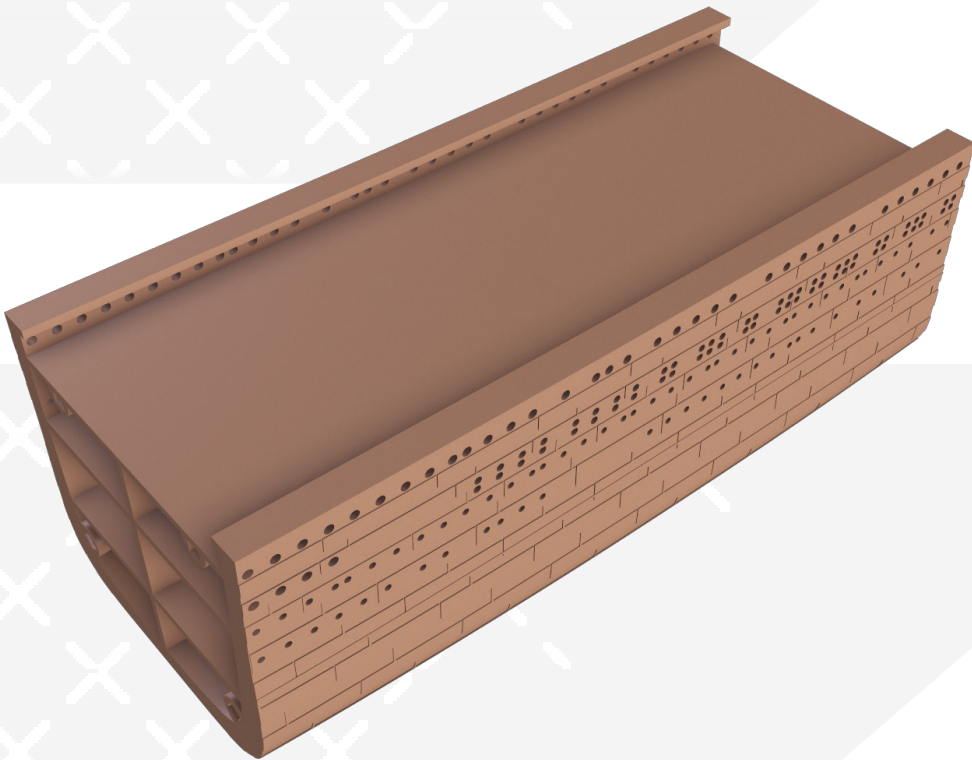
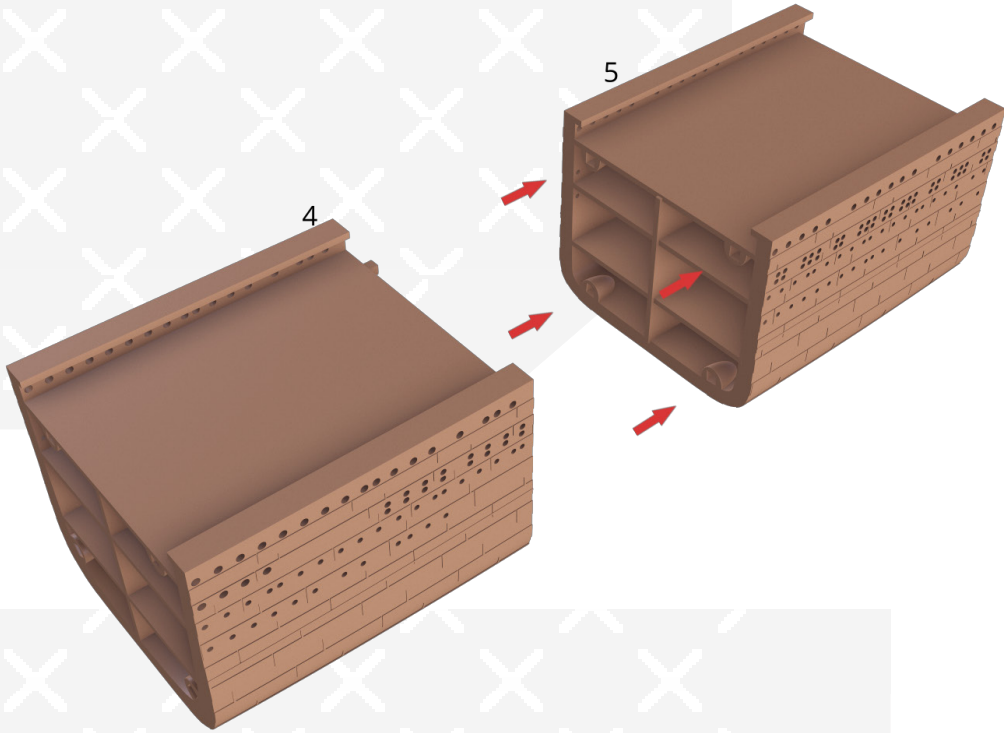

2

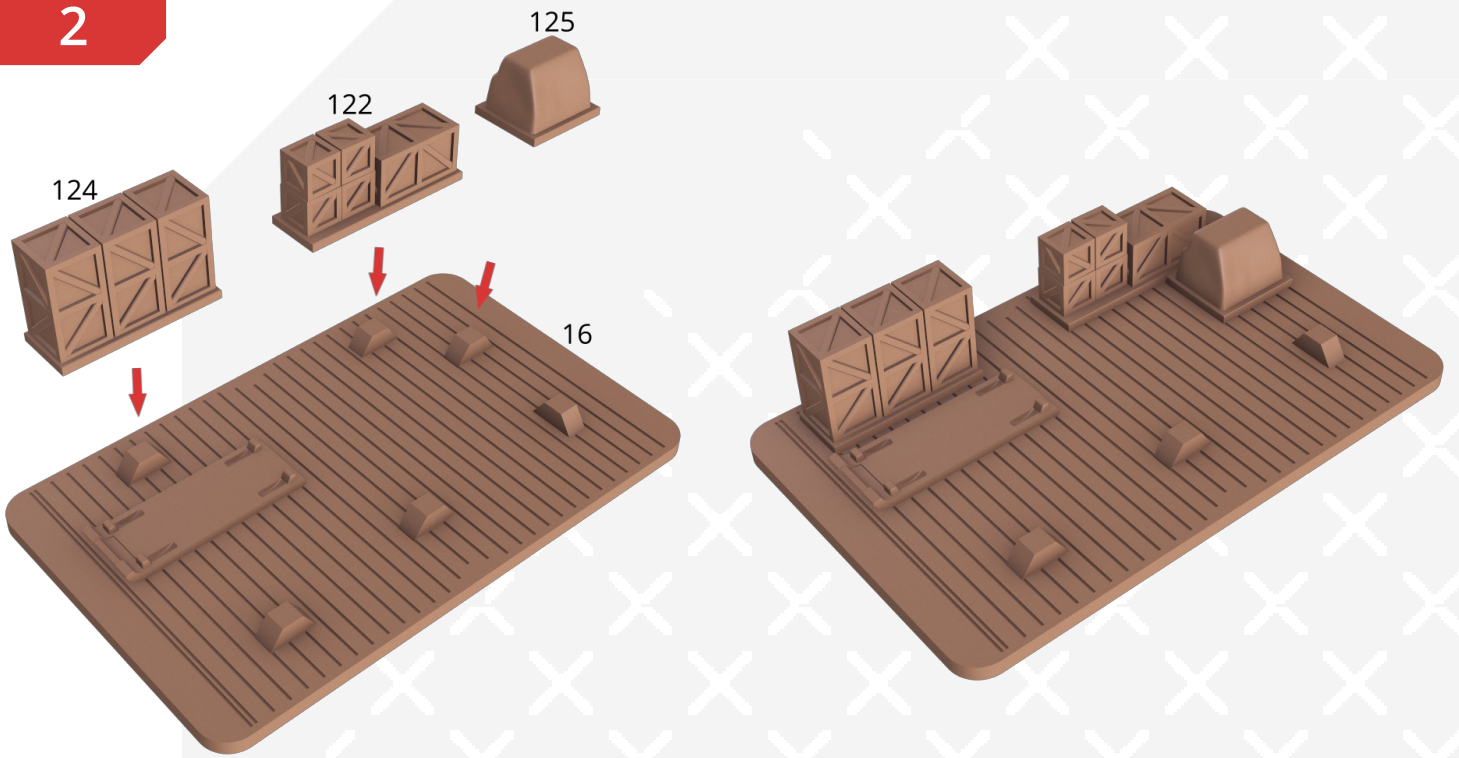

3

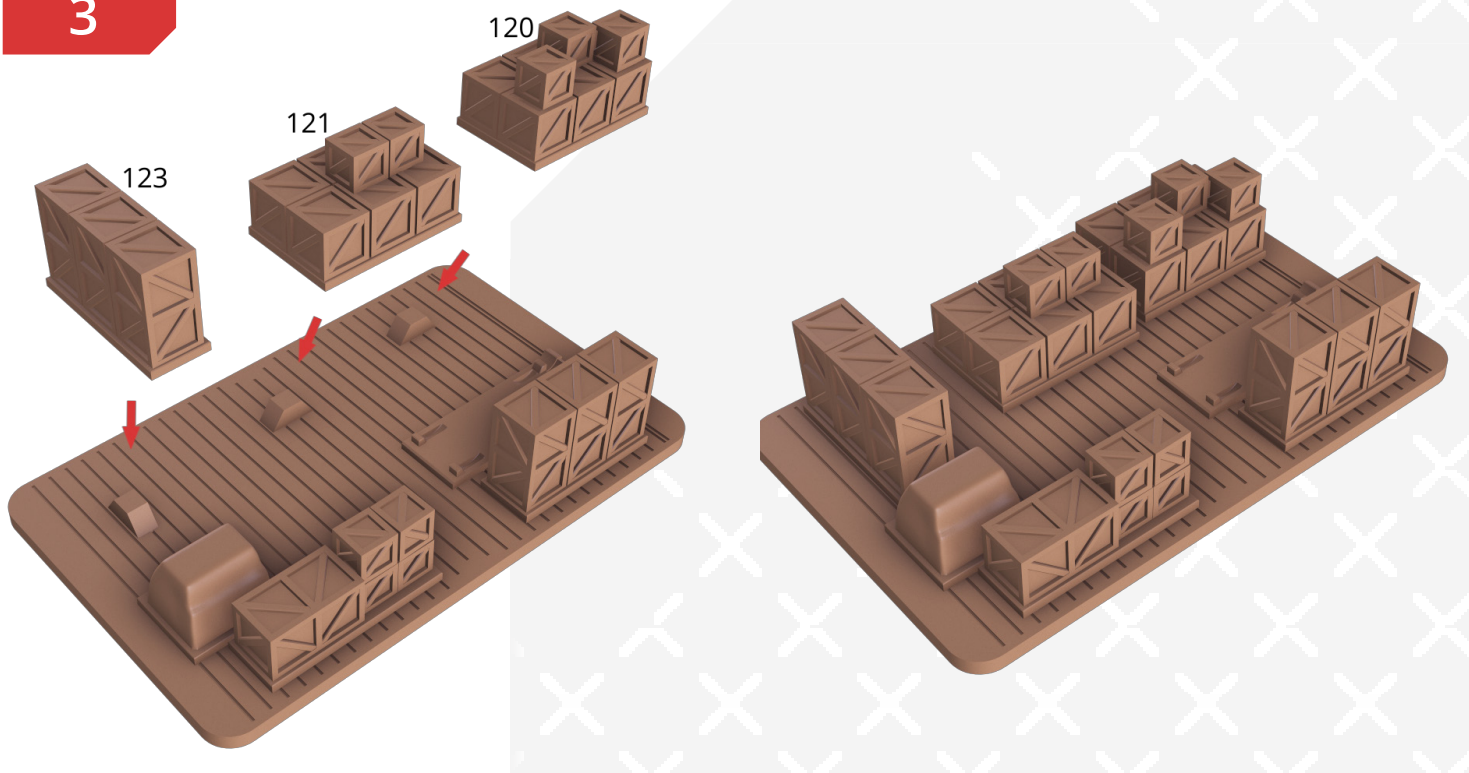

4

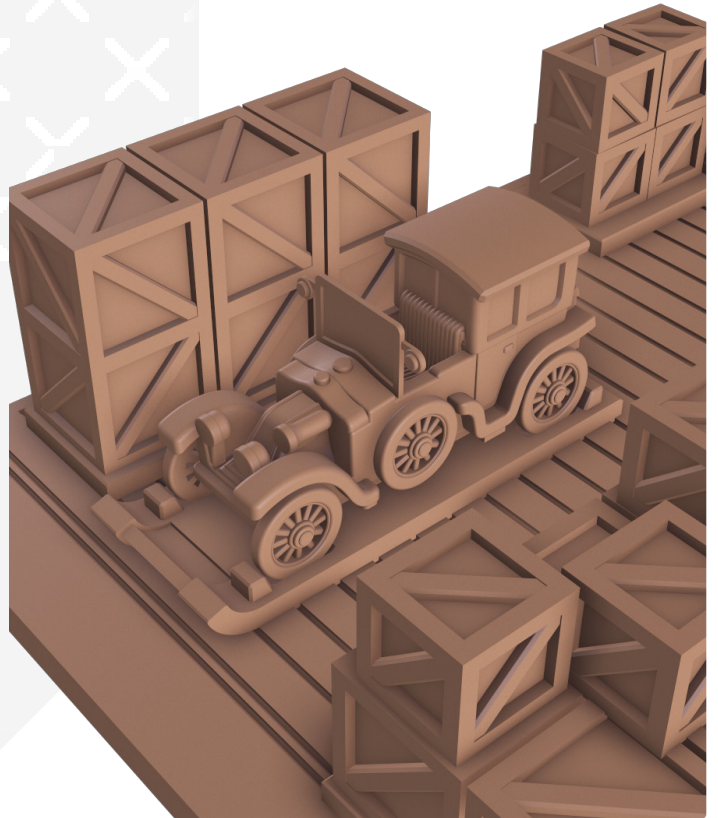

5

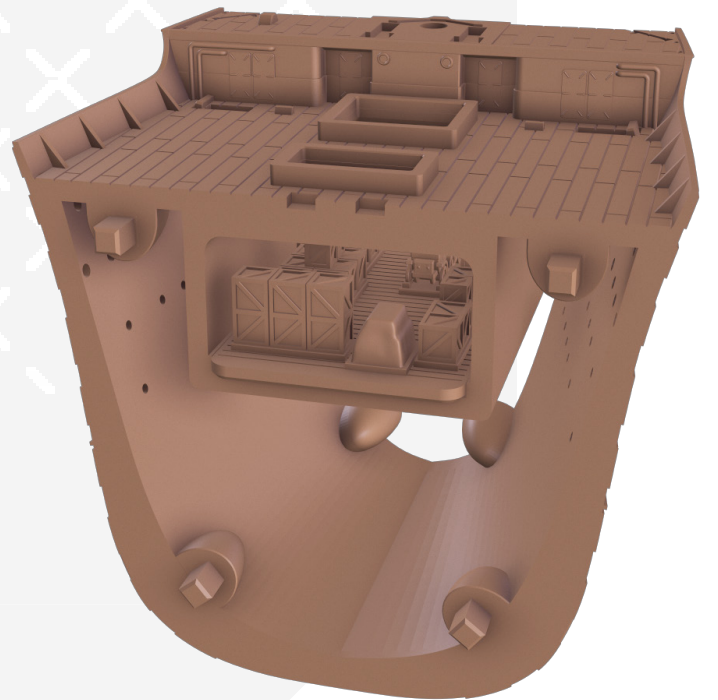
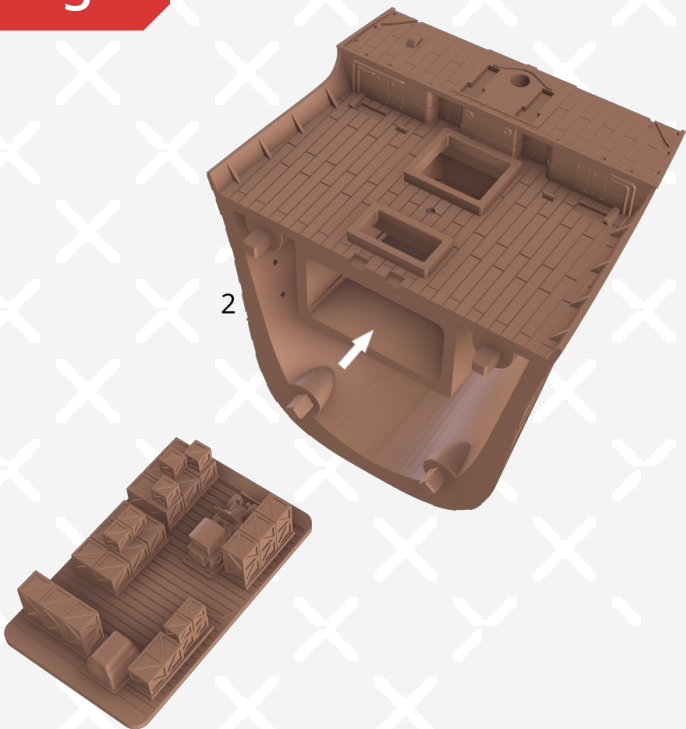

6

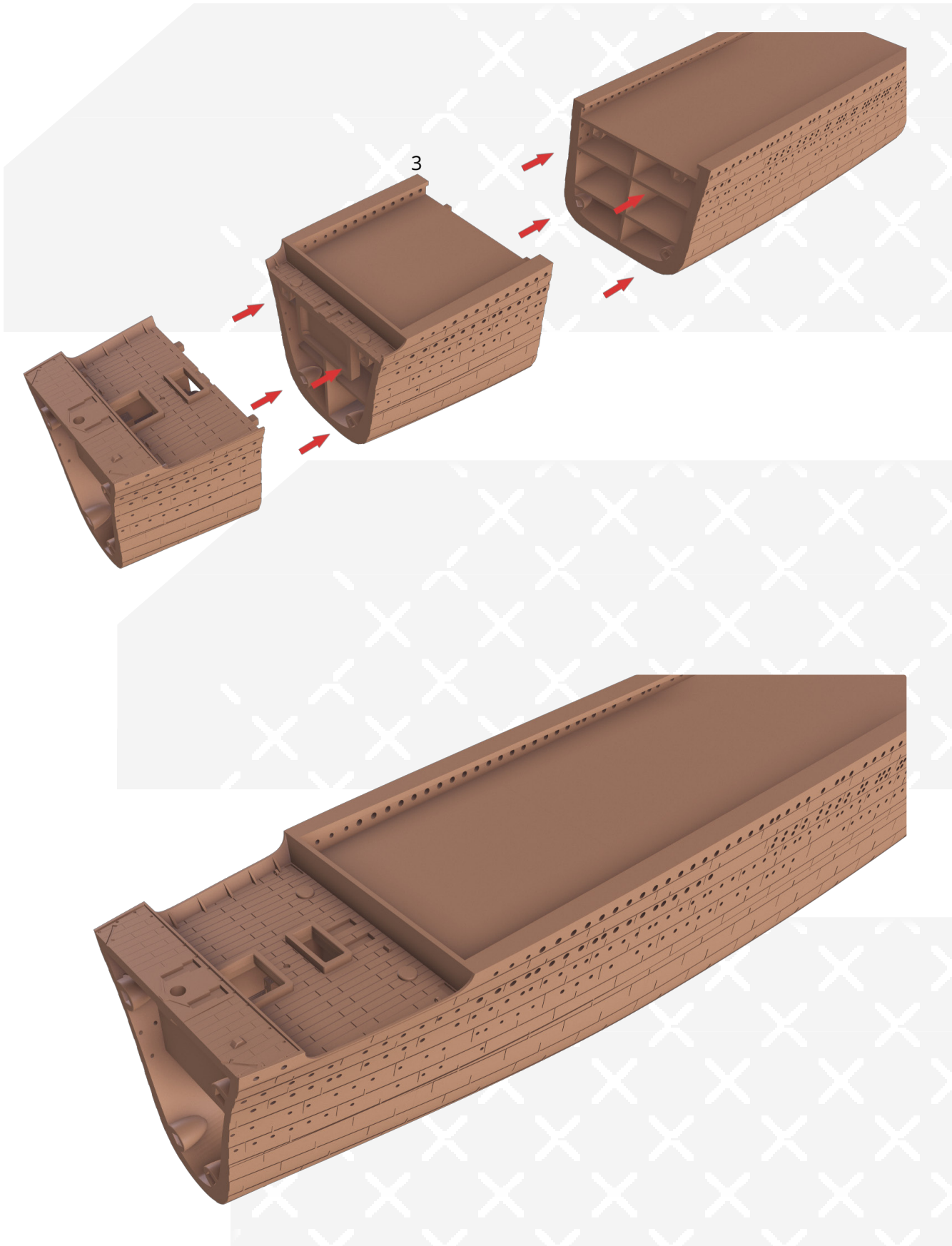

7

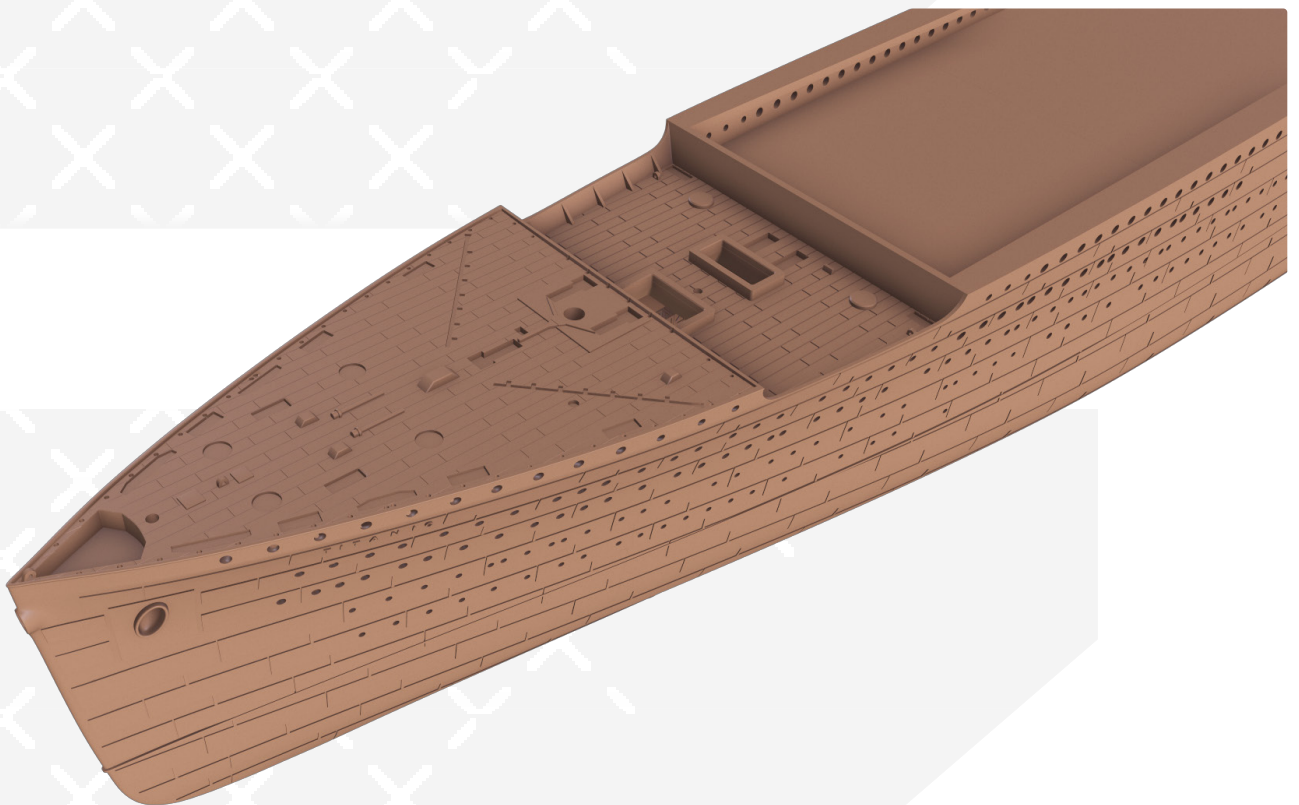
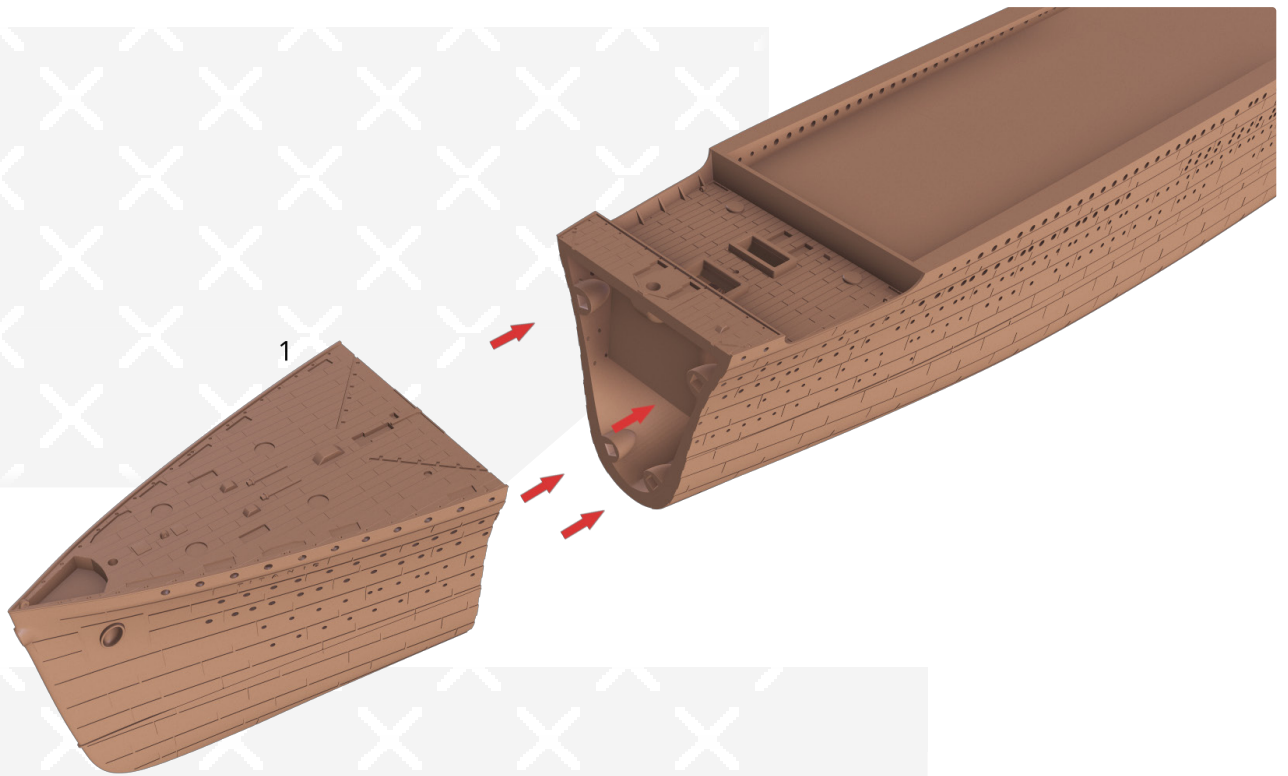

8

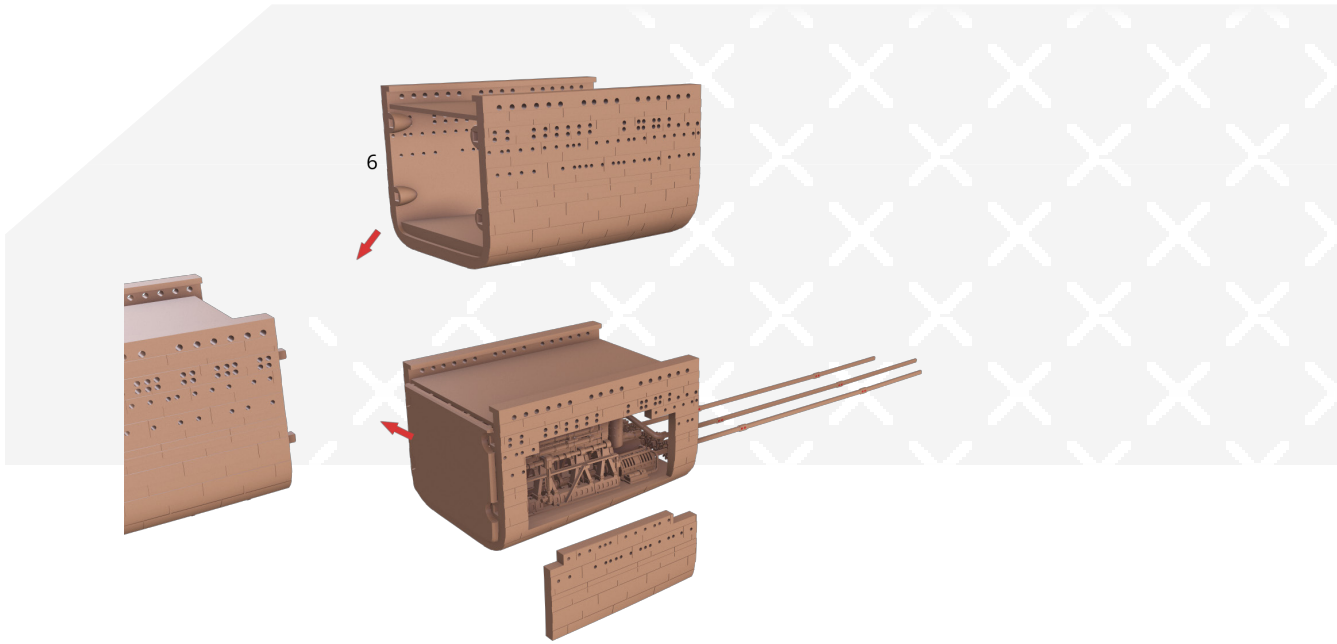

You can insert either an included part #6 or an engine model specifically assembled for installation on the Titanic.

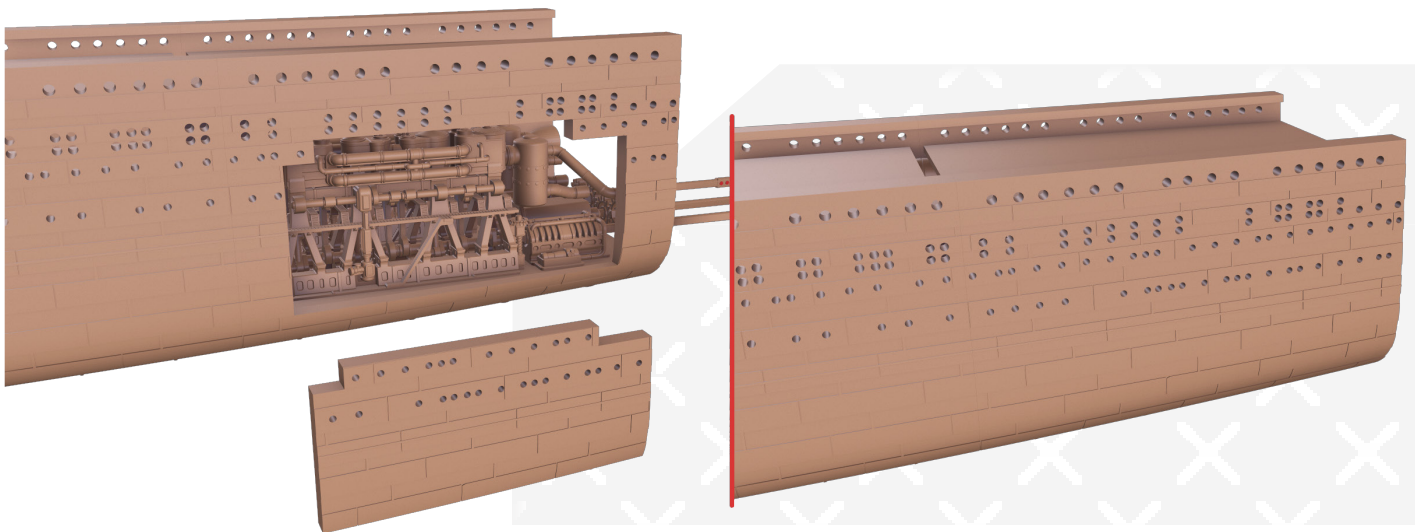

9

10

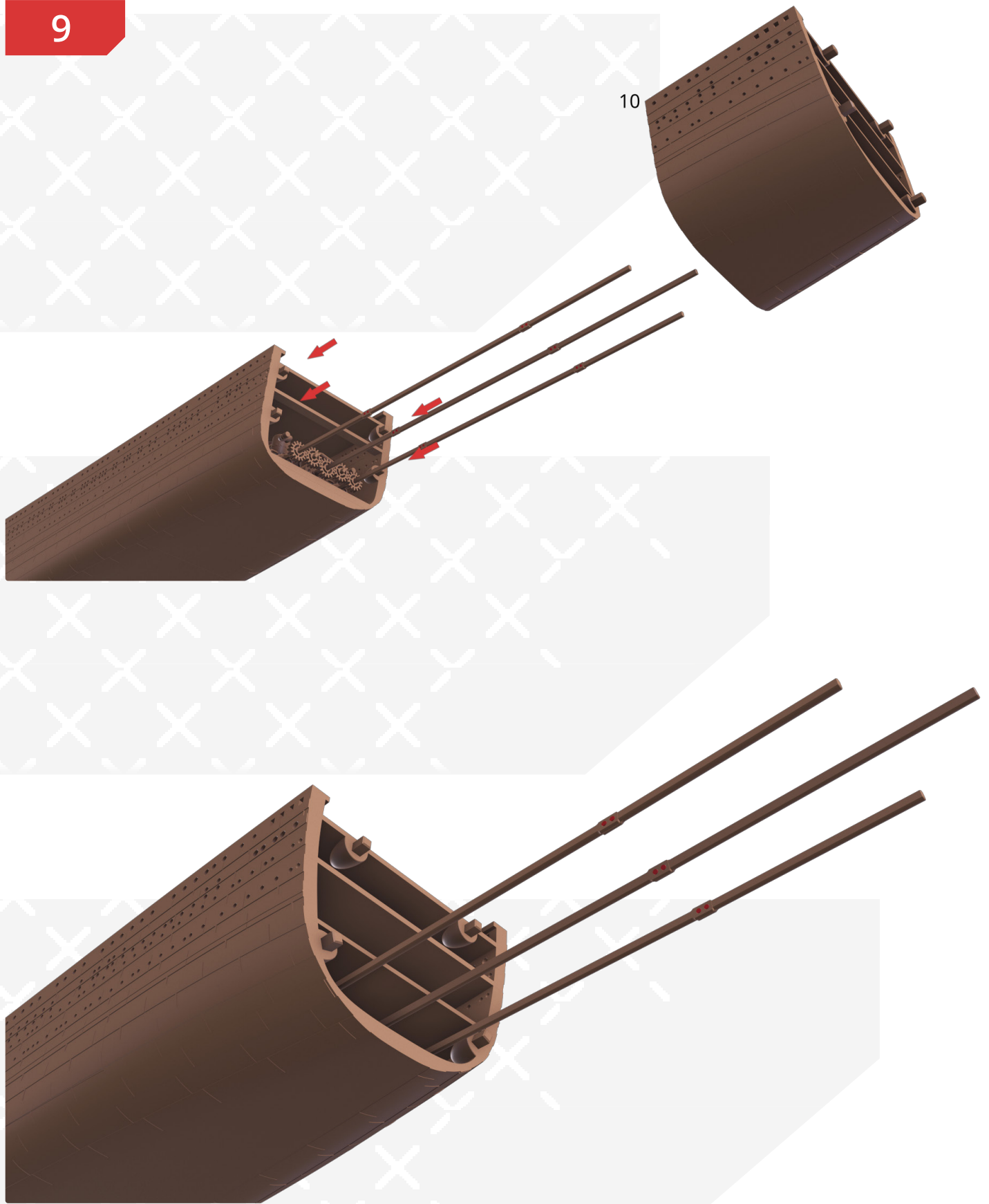

10

11

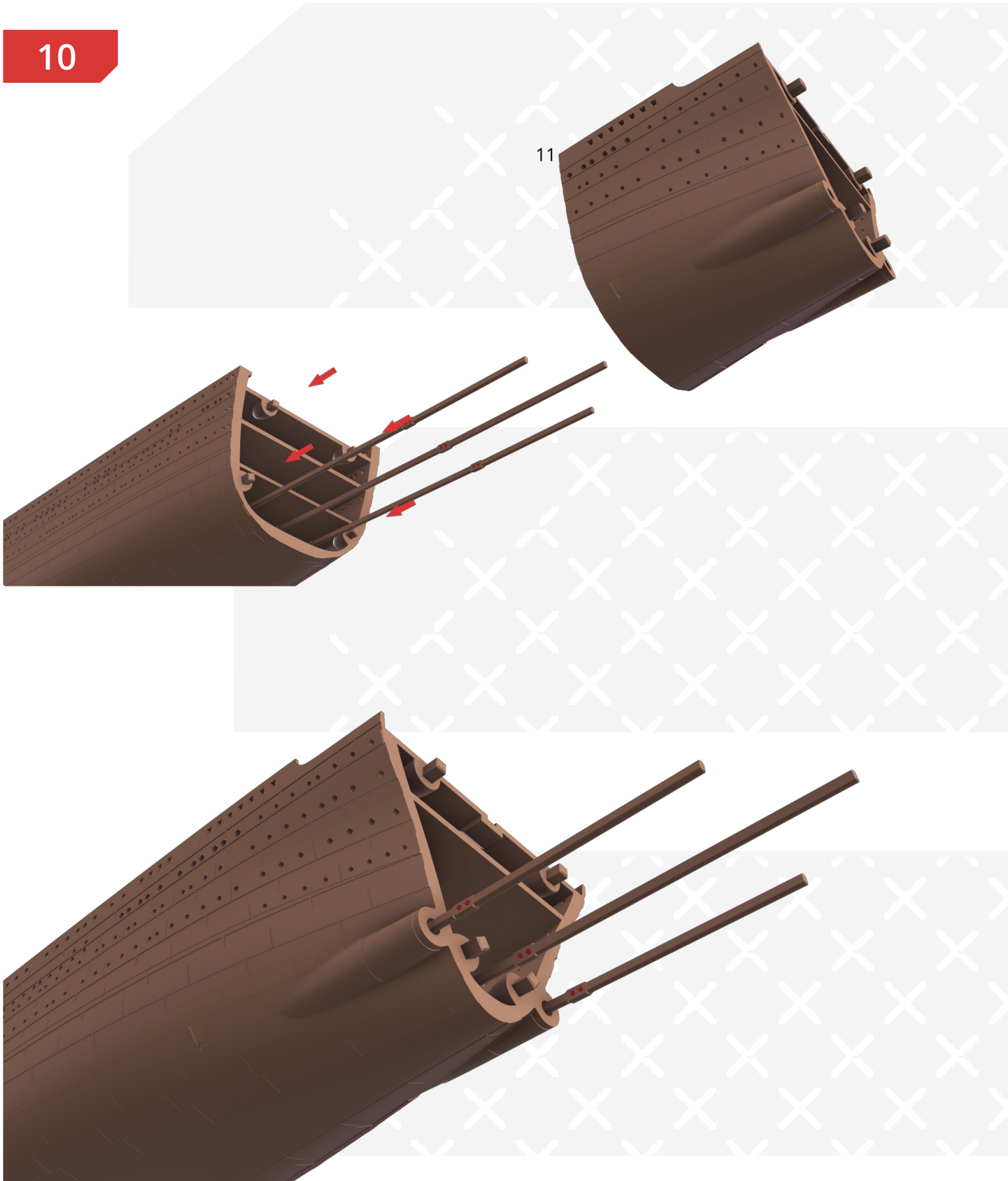

11

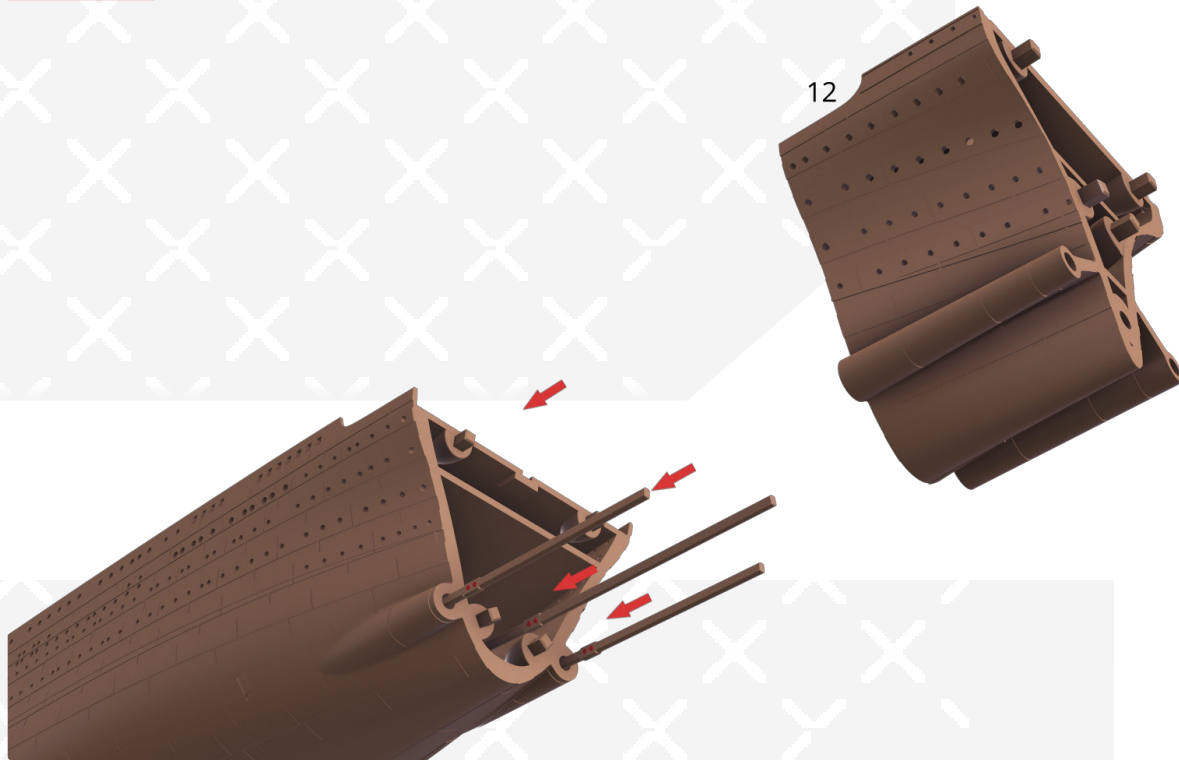

12



12



Attach the part #13 or place the shaft pieces (parts #145-146) where propellers can be installed.

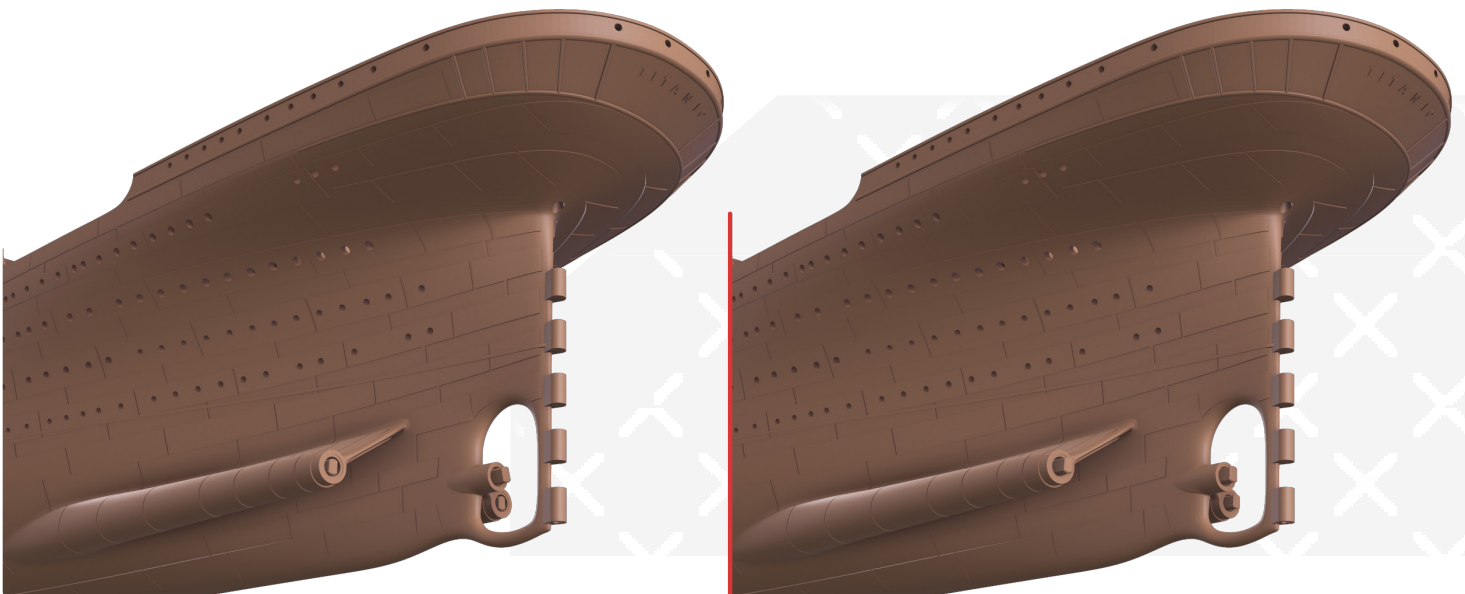

13

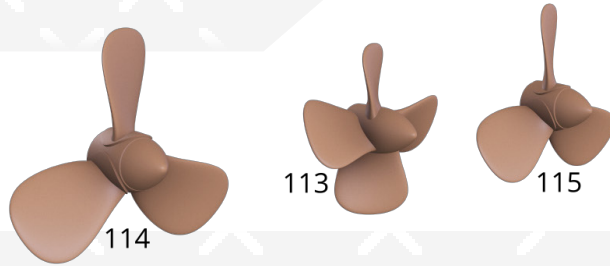
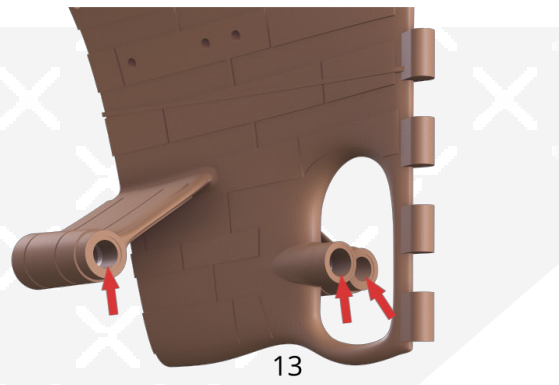

14

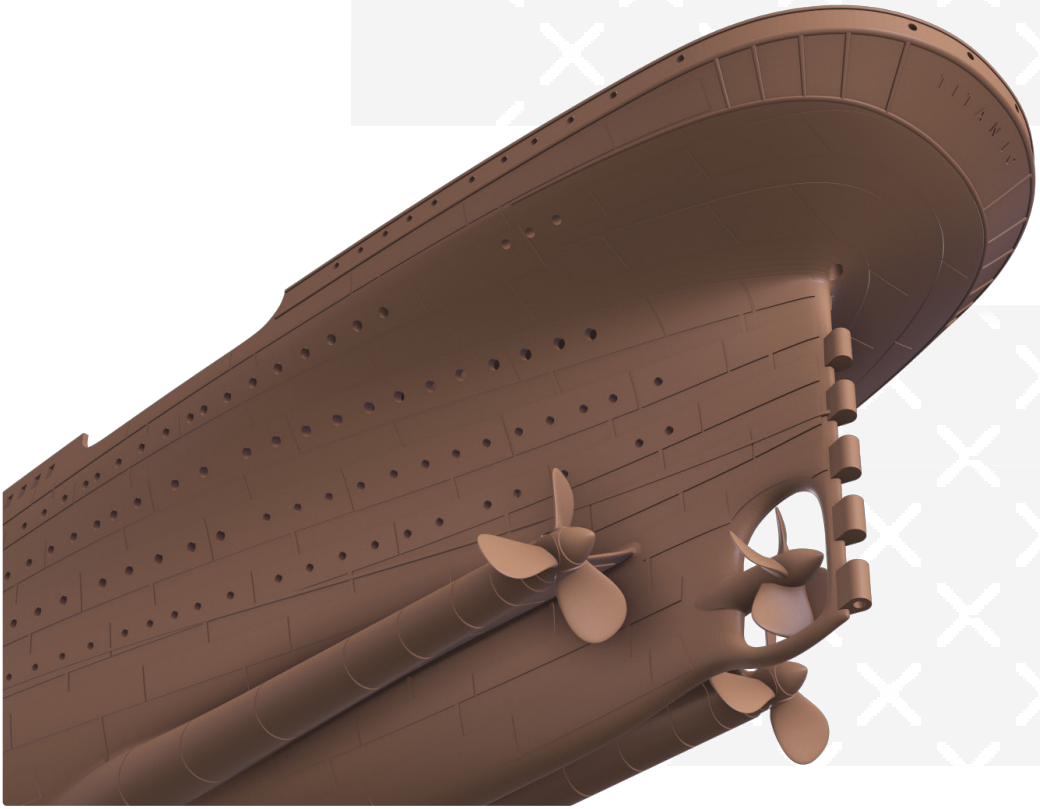
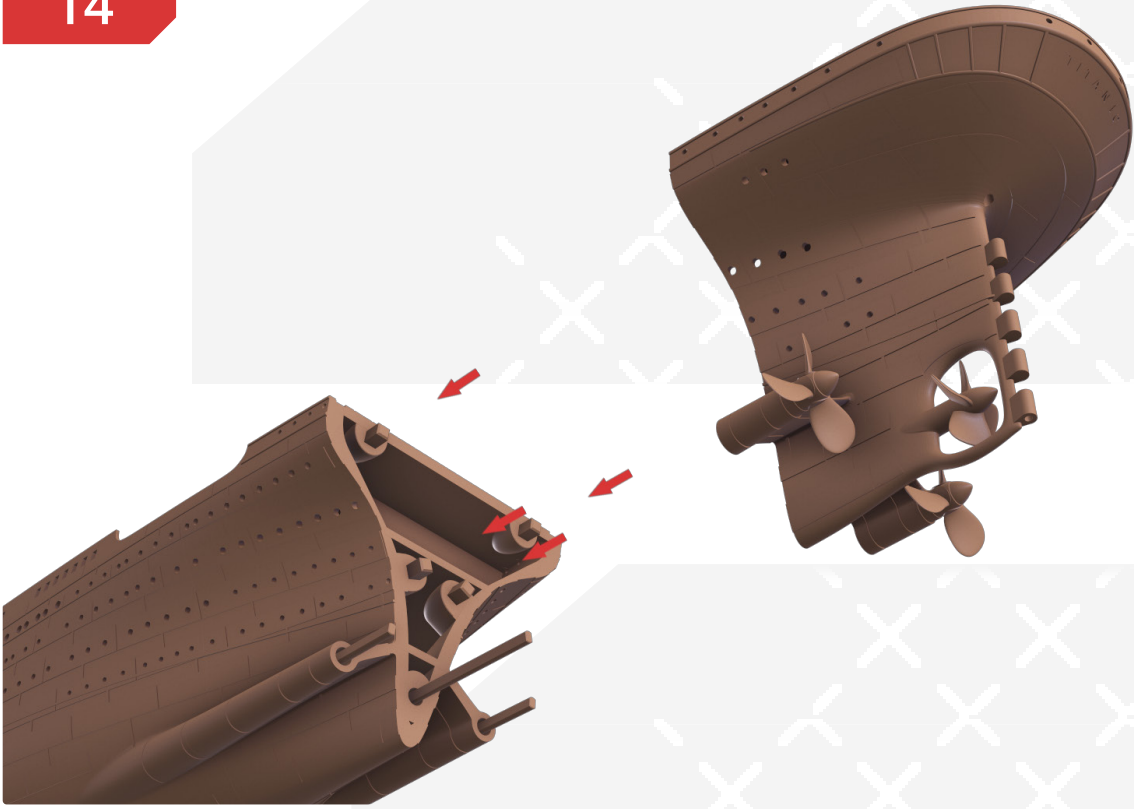

15

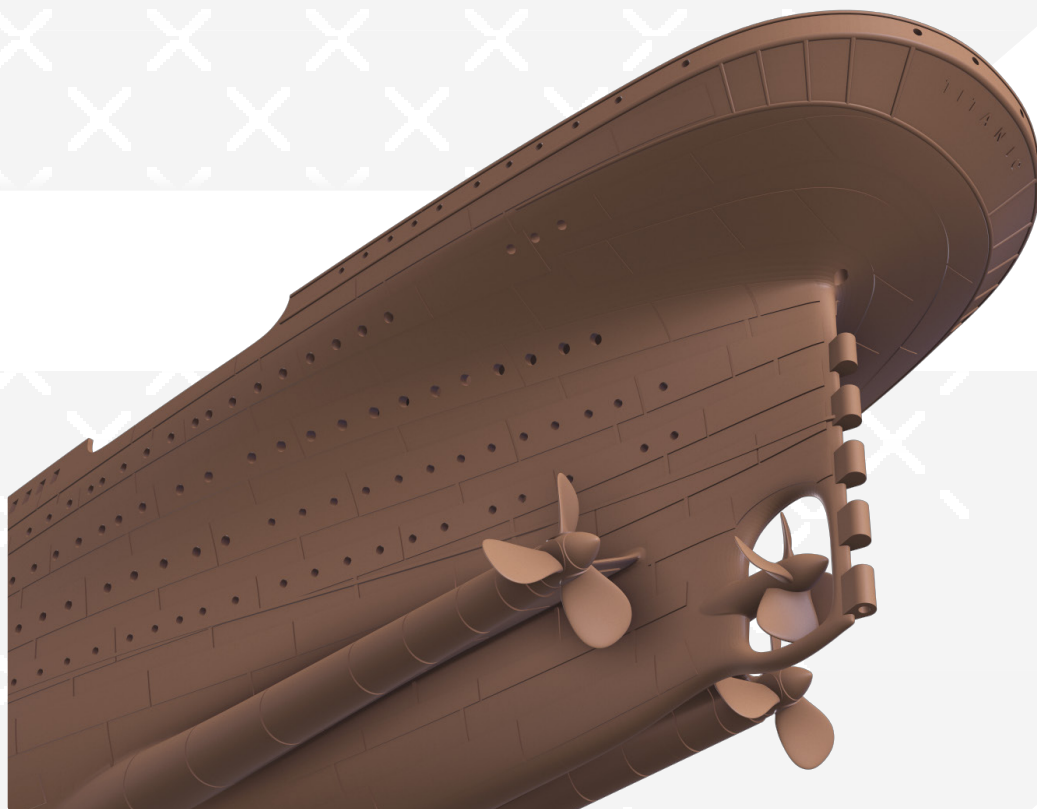

The red parts in the SLA version are wire pins.

16

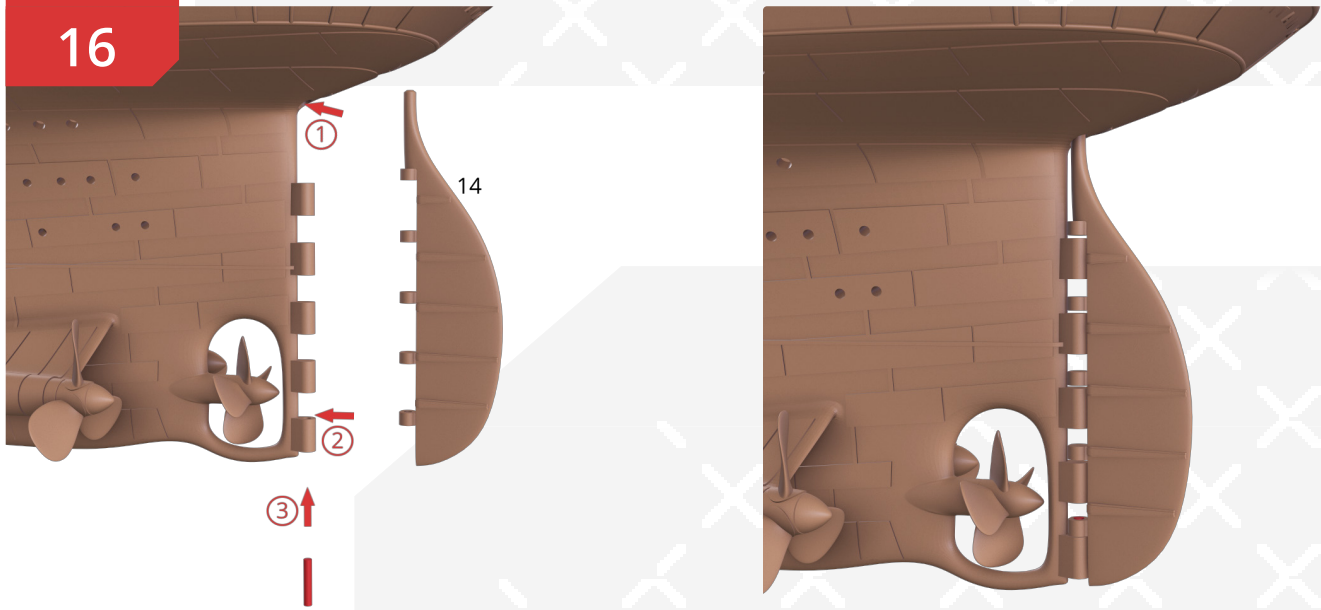

17



18

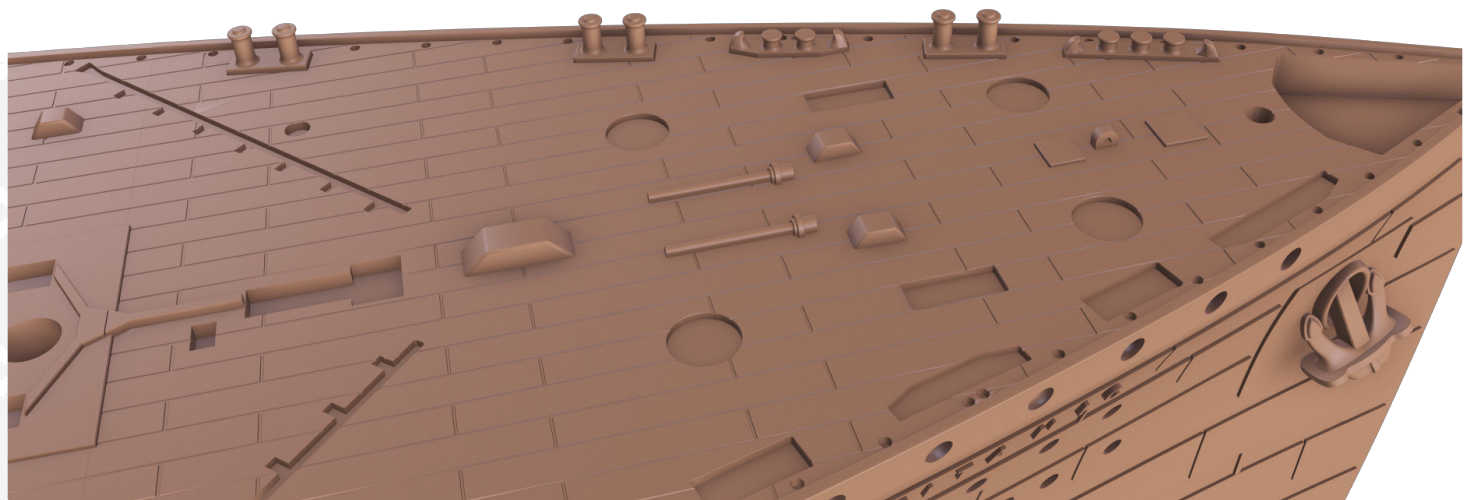
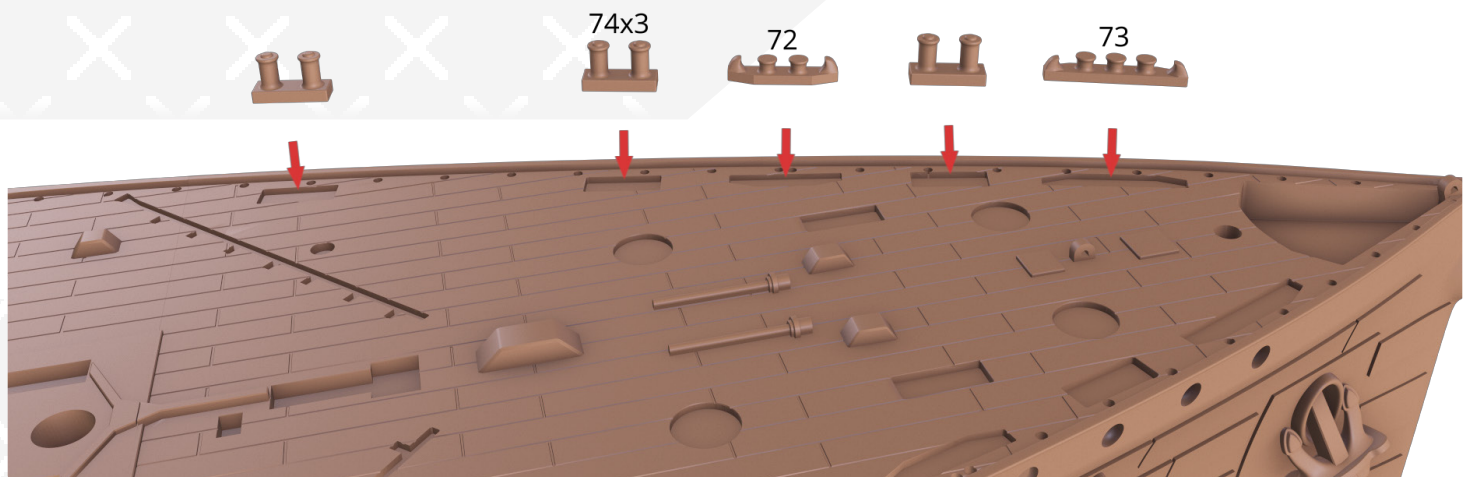

19

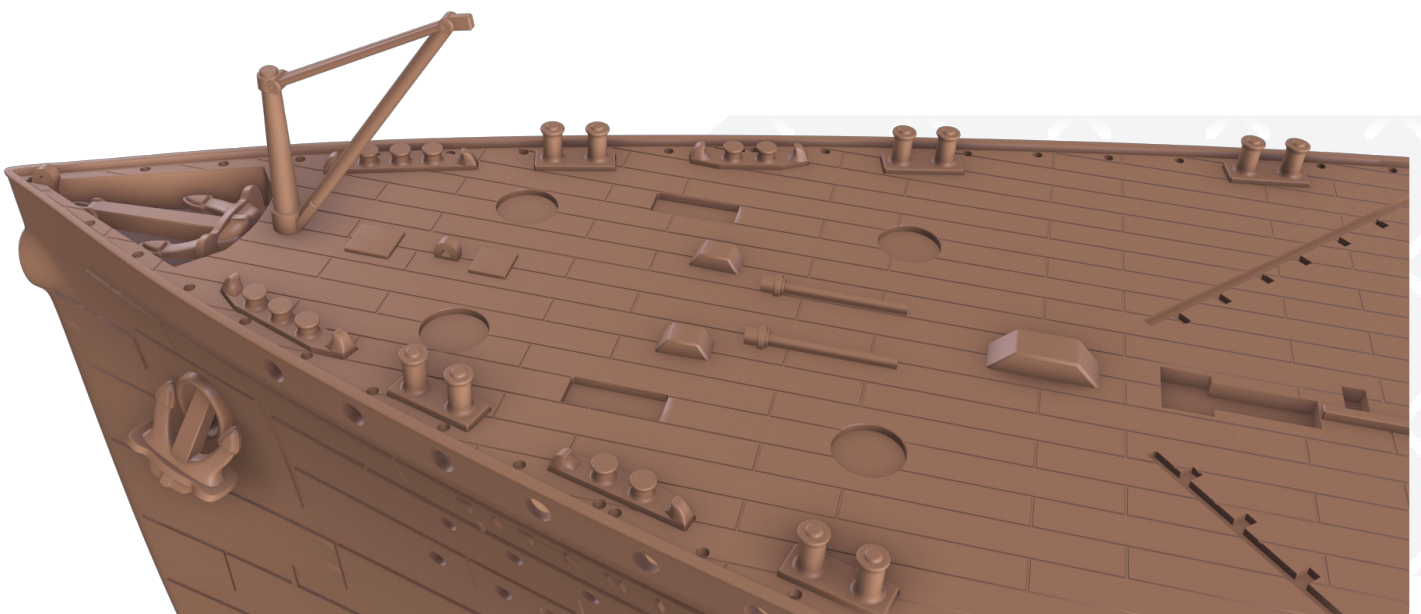
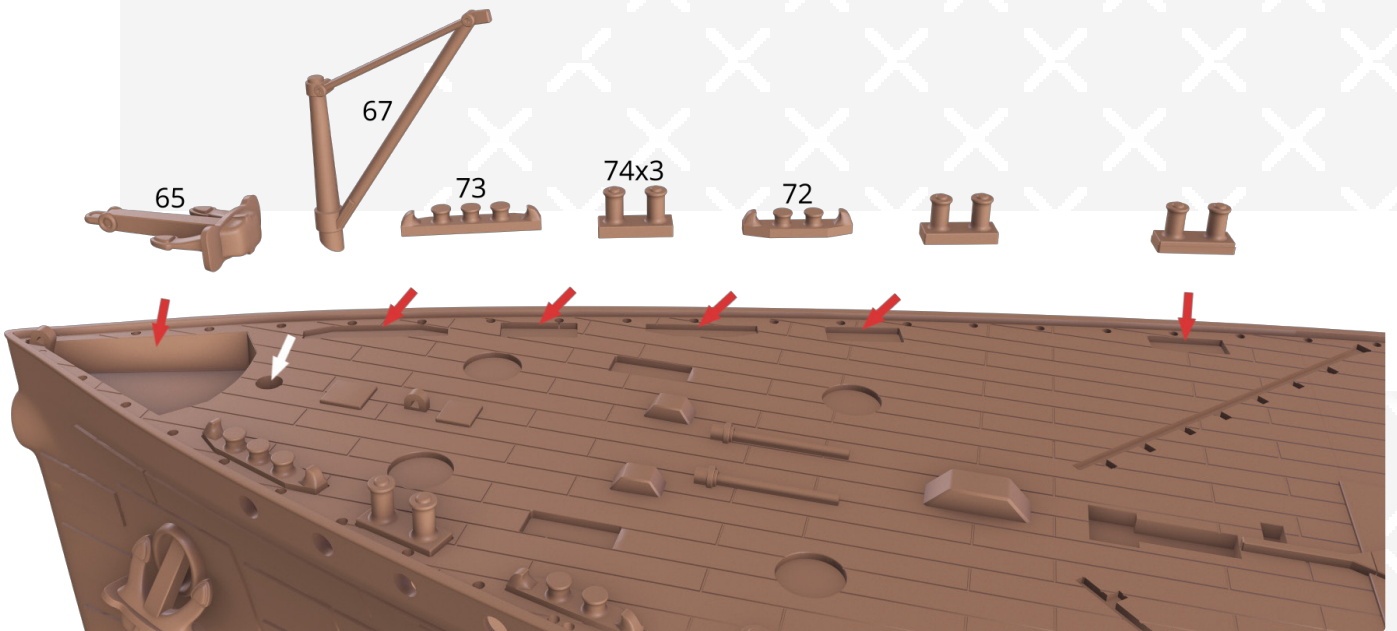

20



95

70x2



69

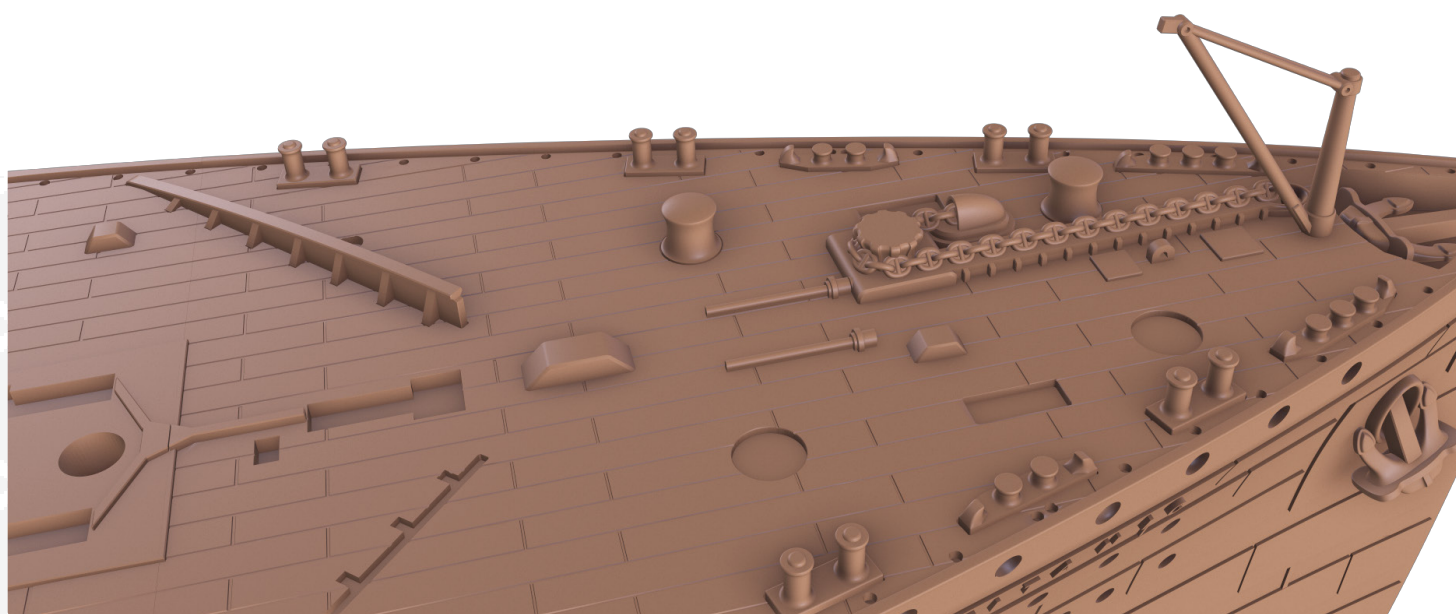
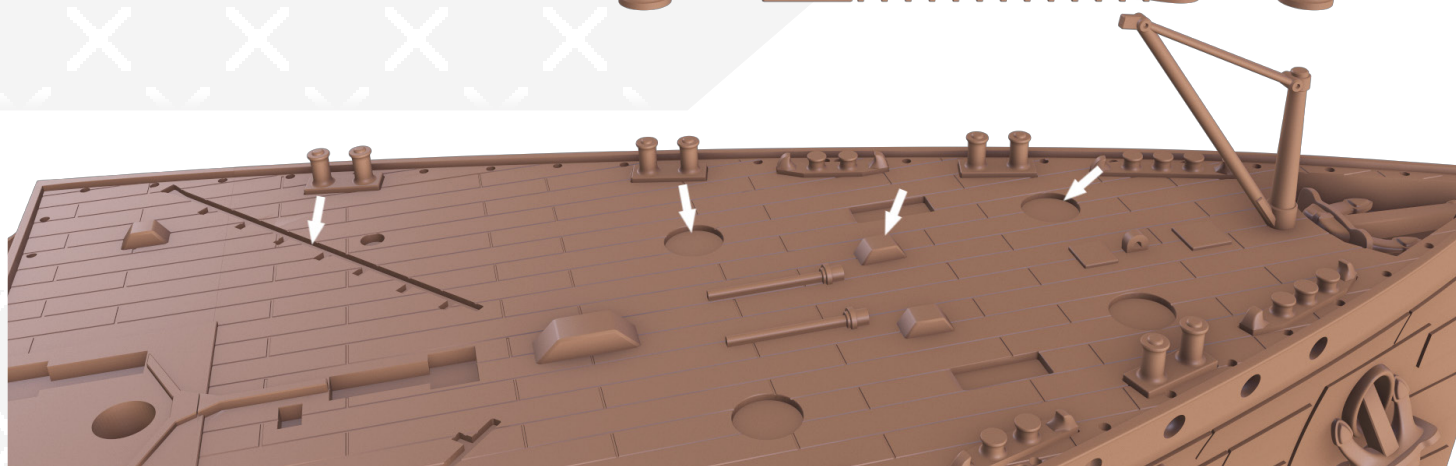

21

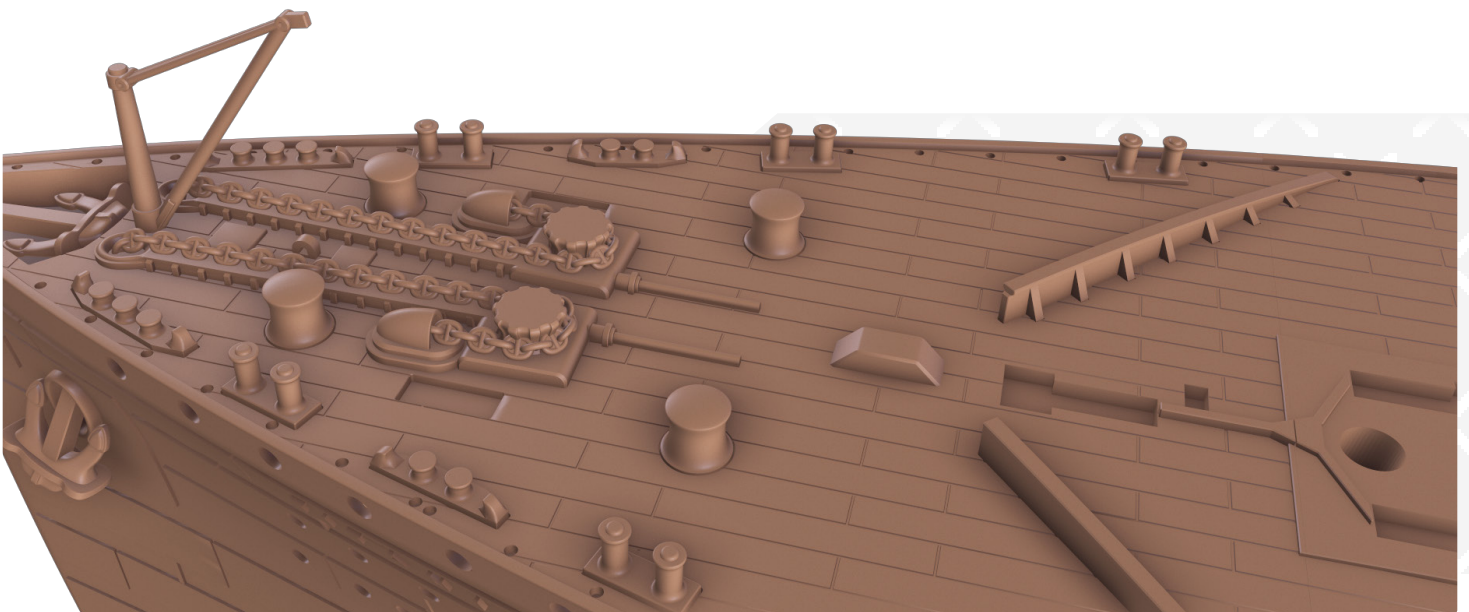
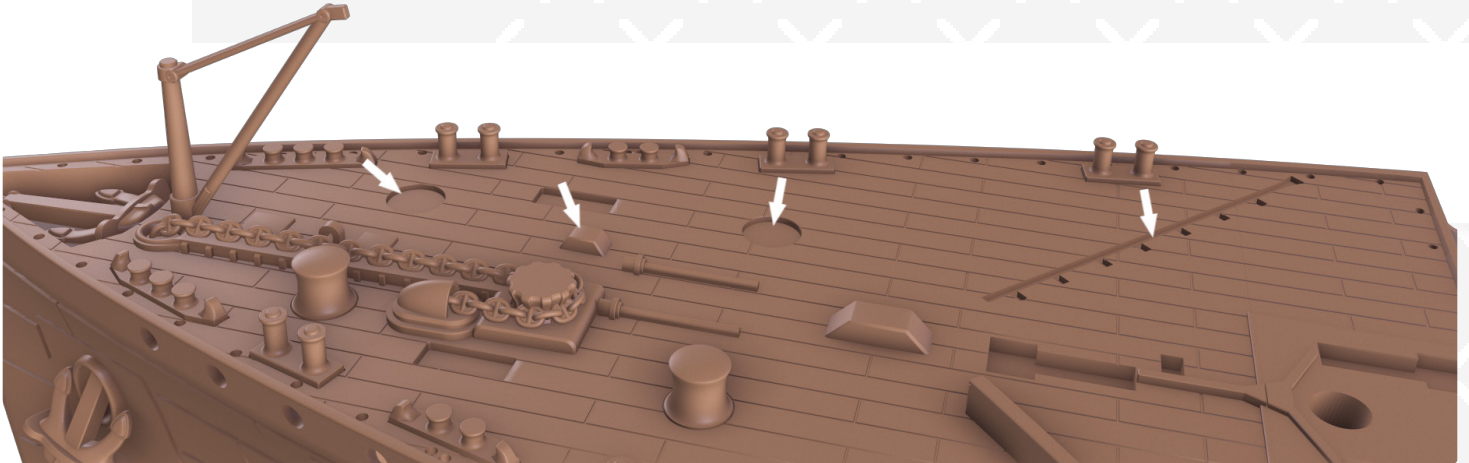

22

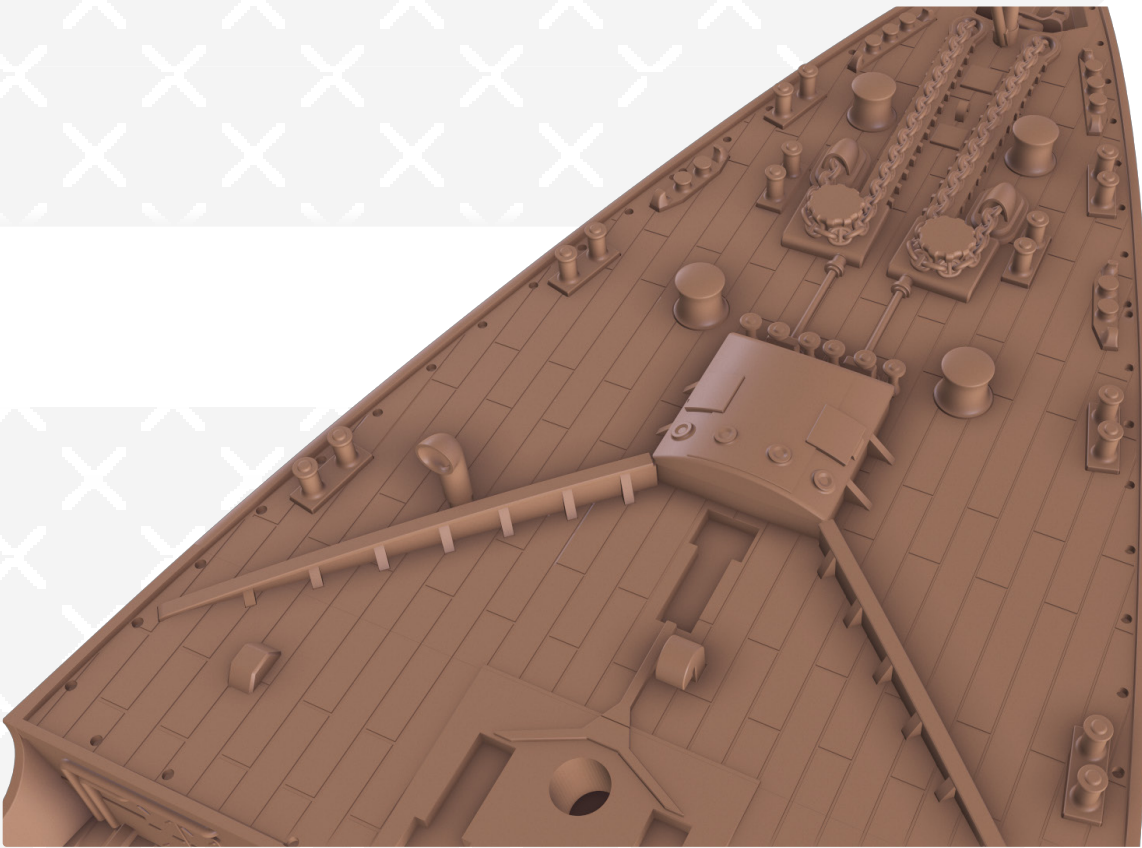
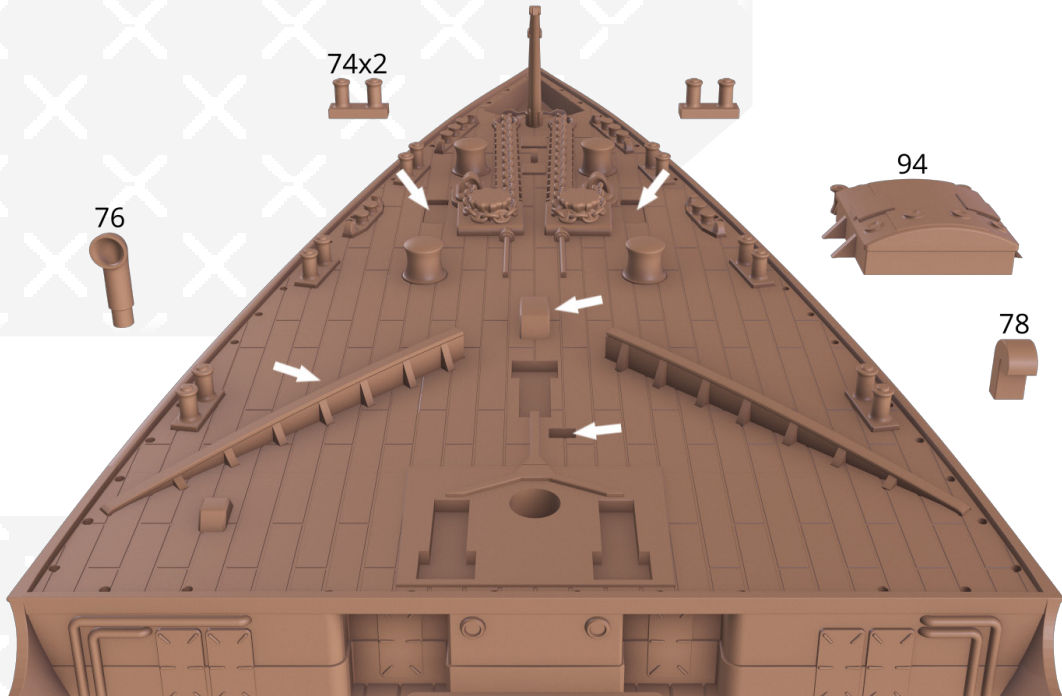

23

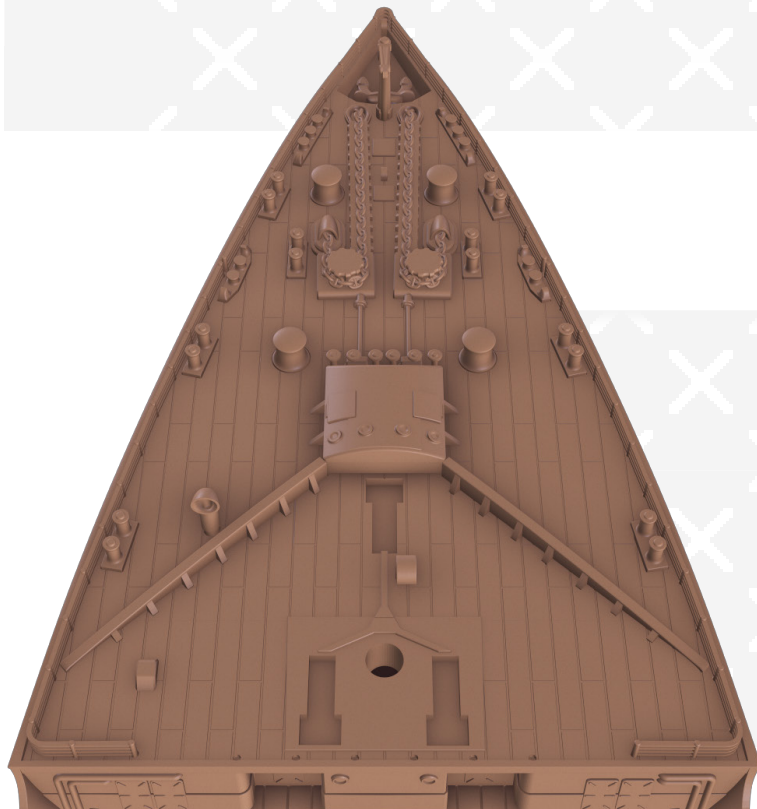
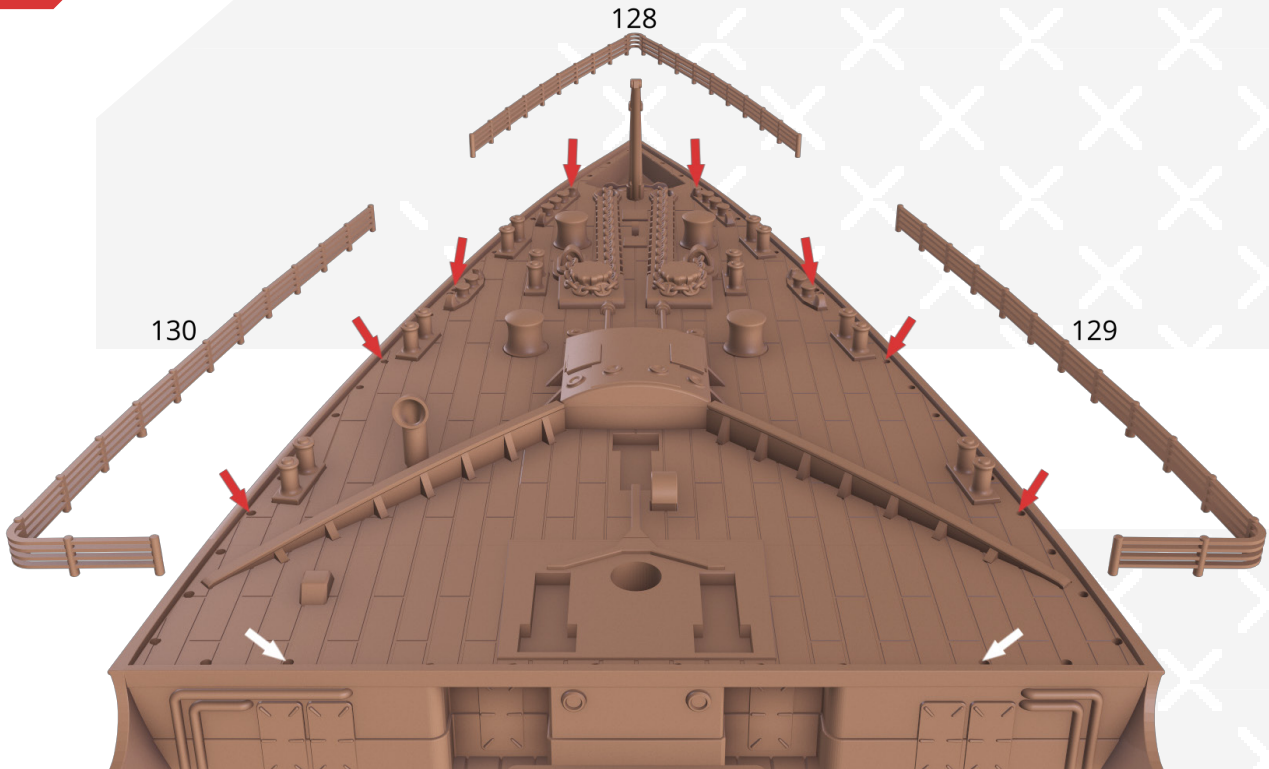

24

126

127

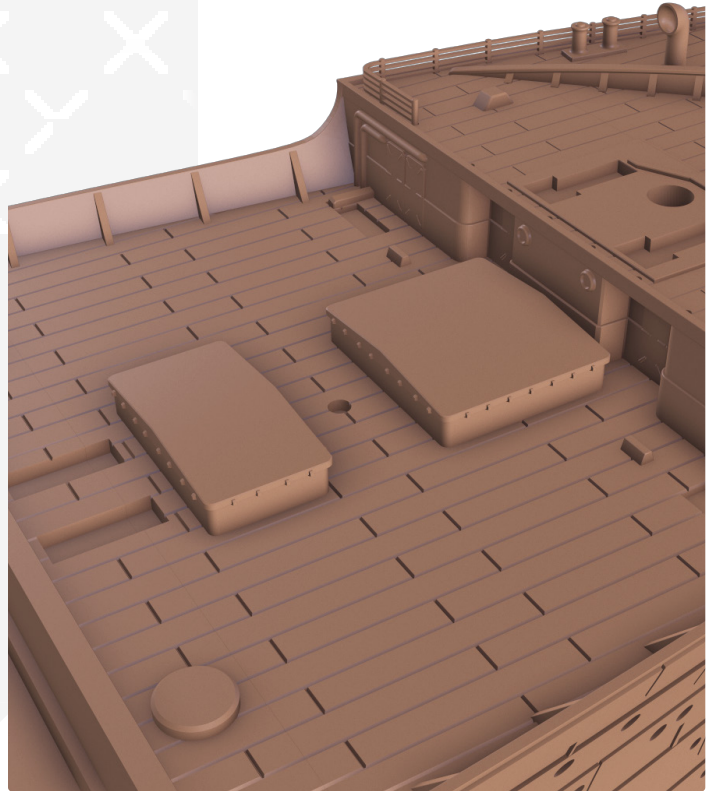
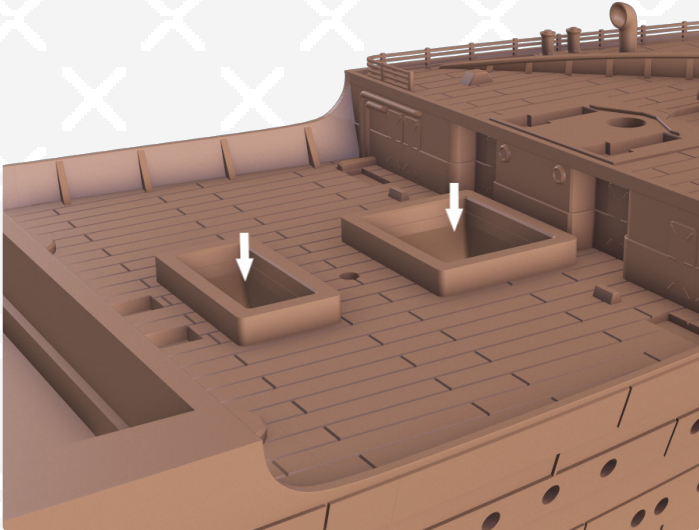

25

102

74

91

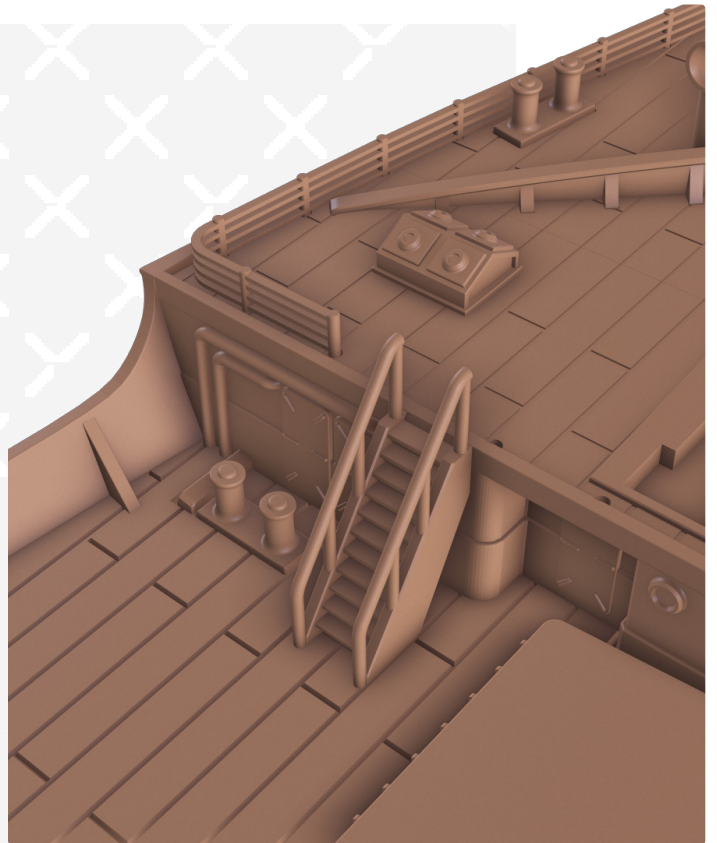
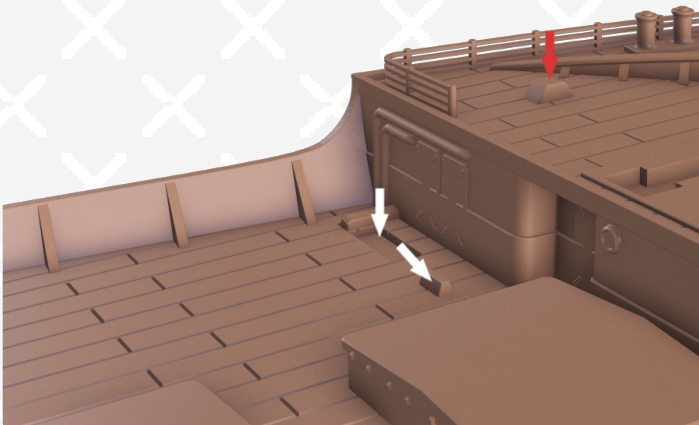

26

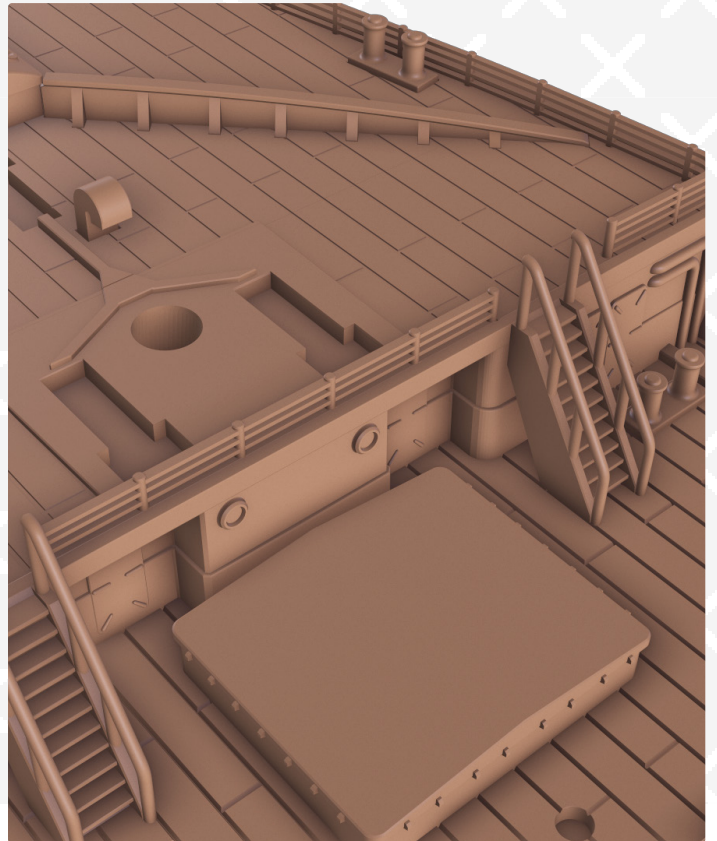
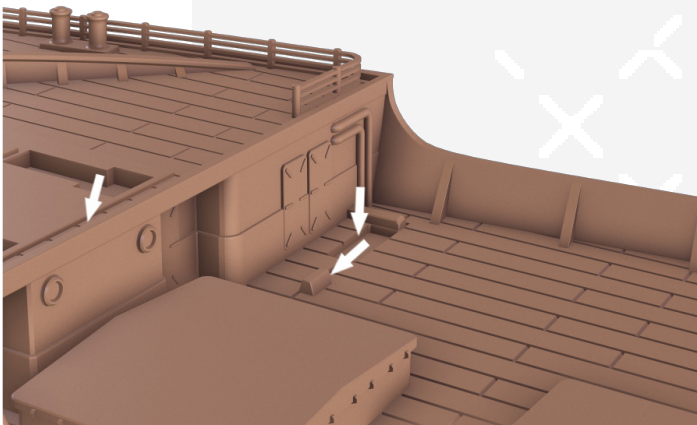
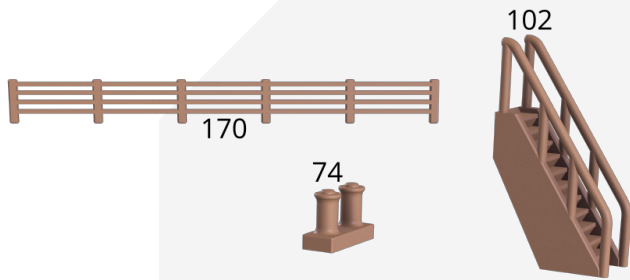

27

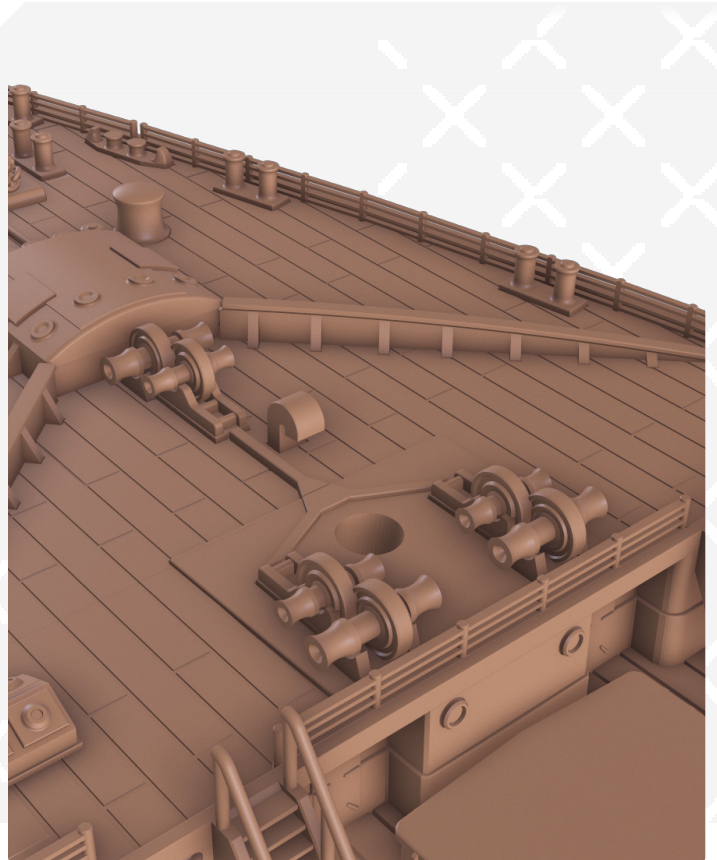
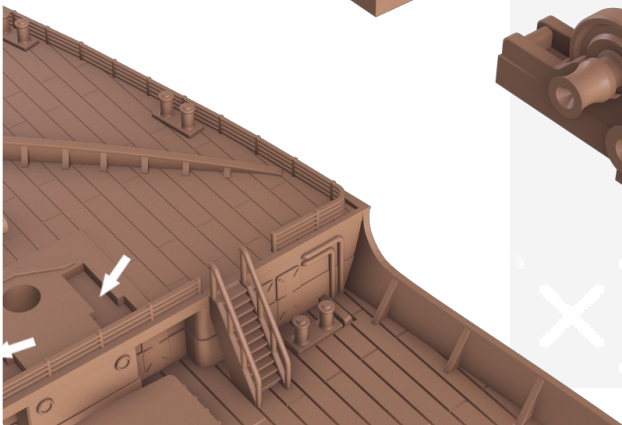
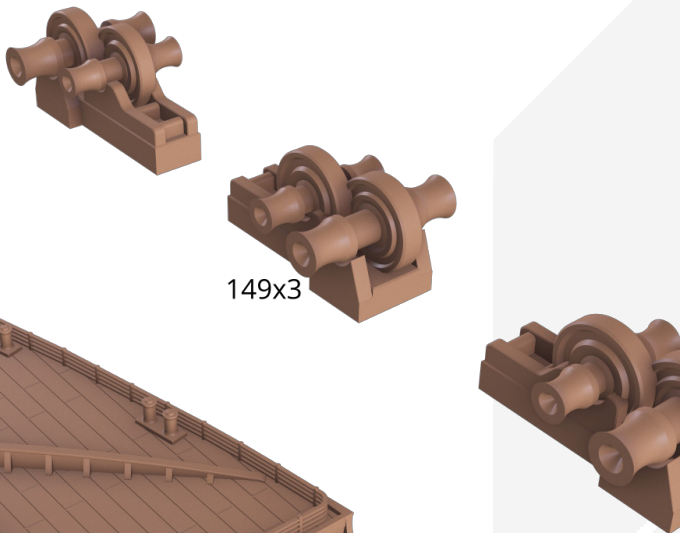

28

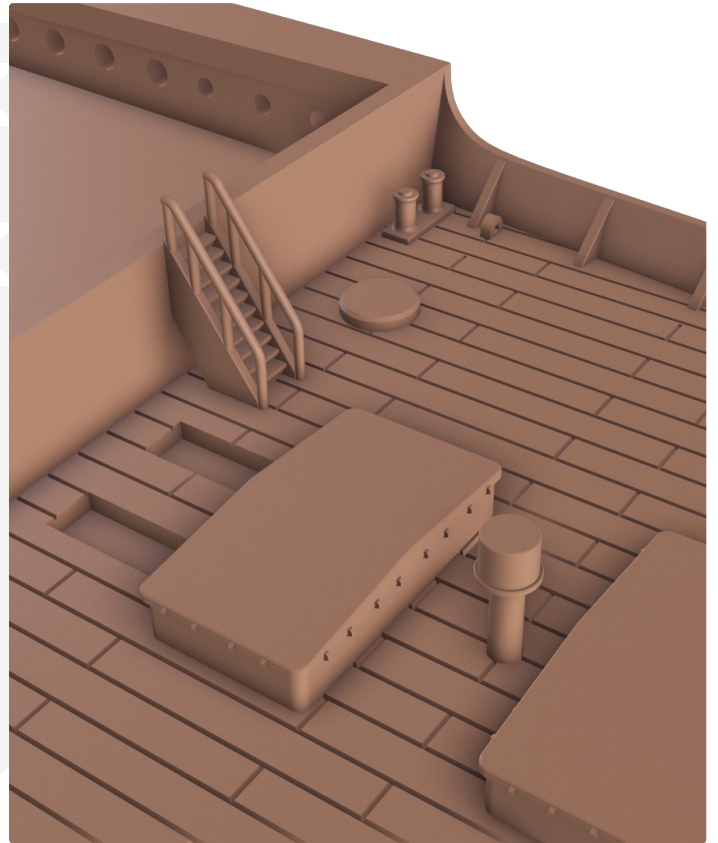
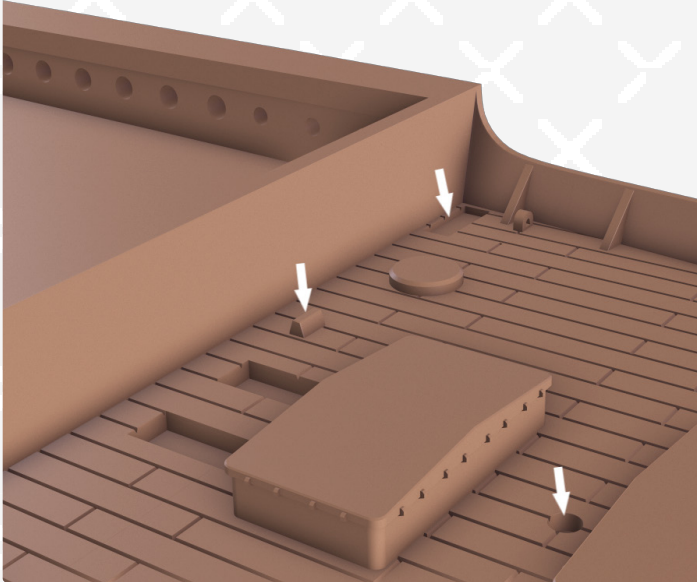
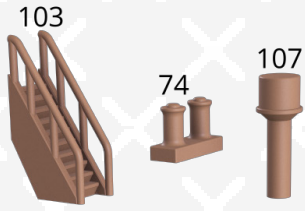

29

REPEAT THIS STEP 3 MORE TIMES

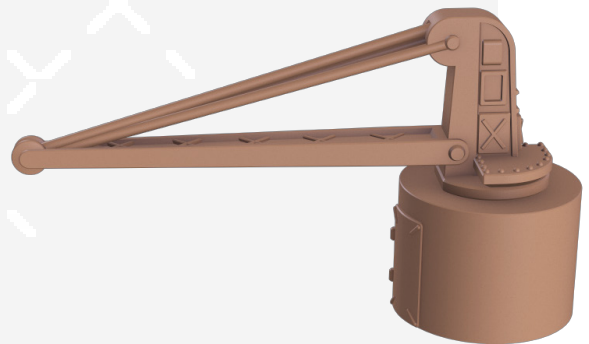
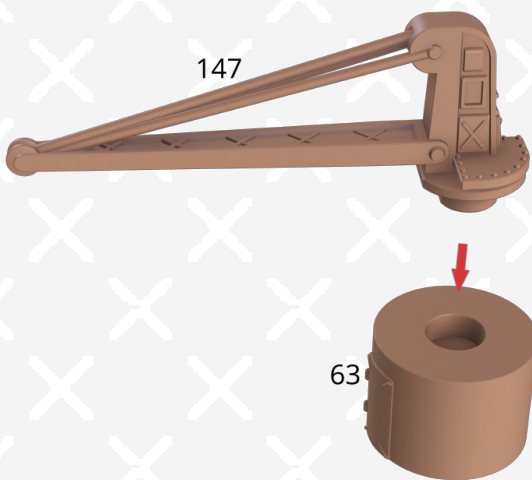

30

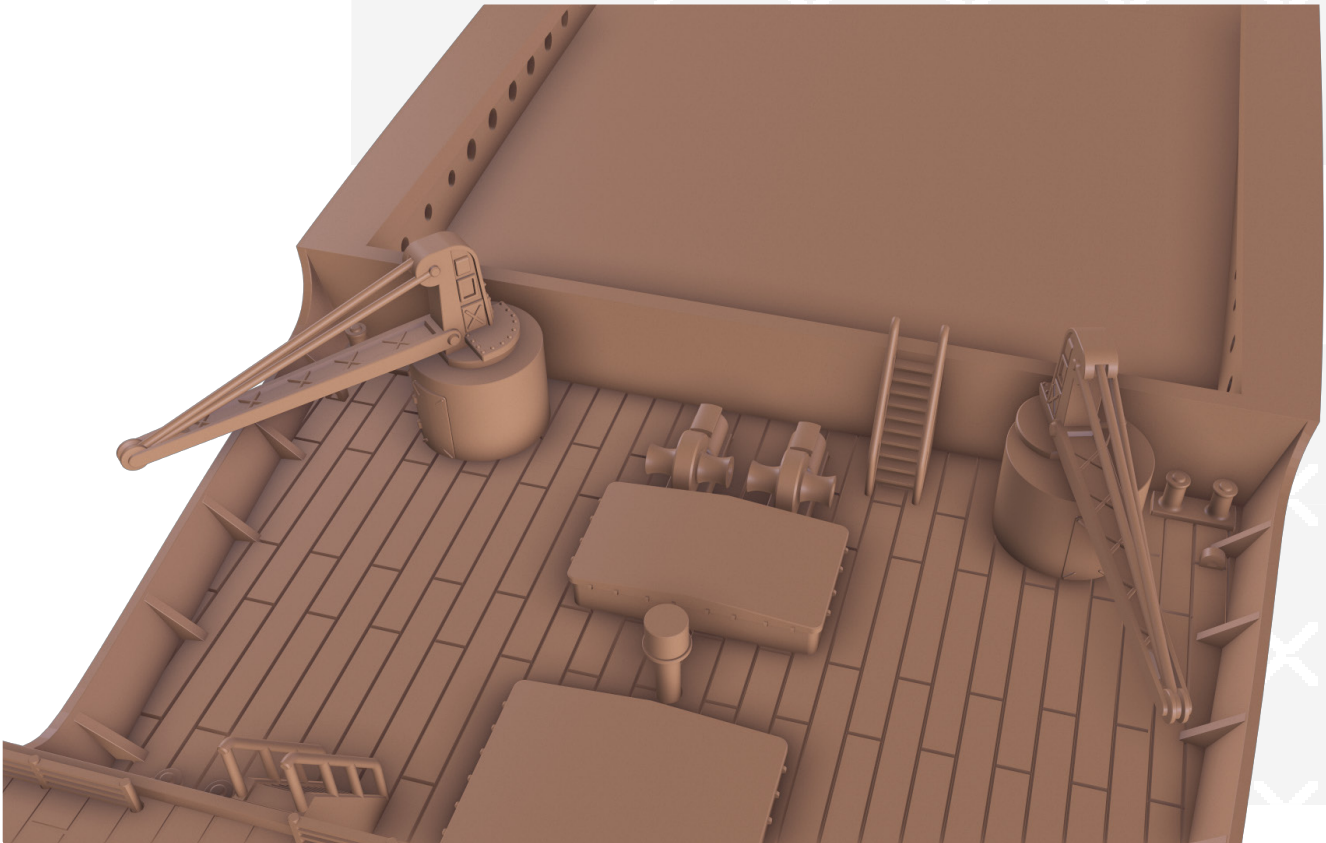
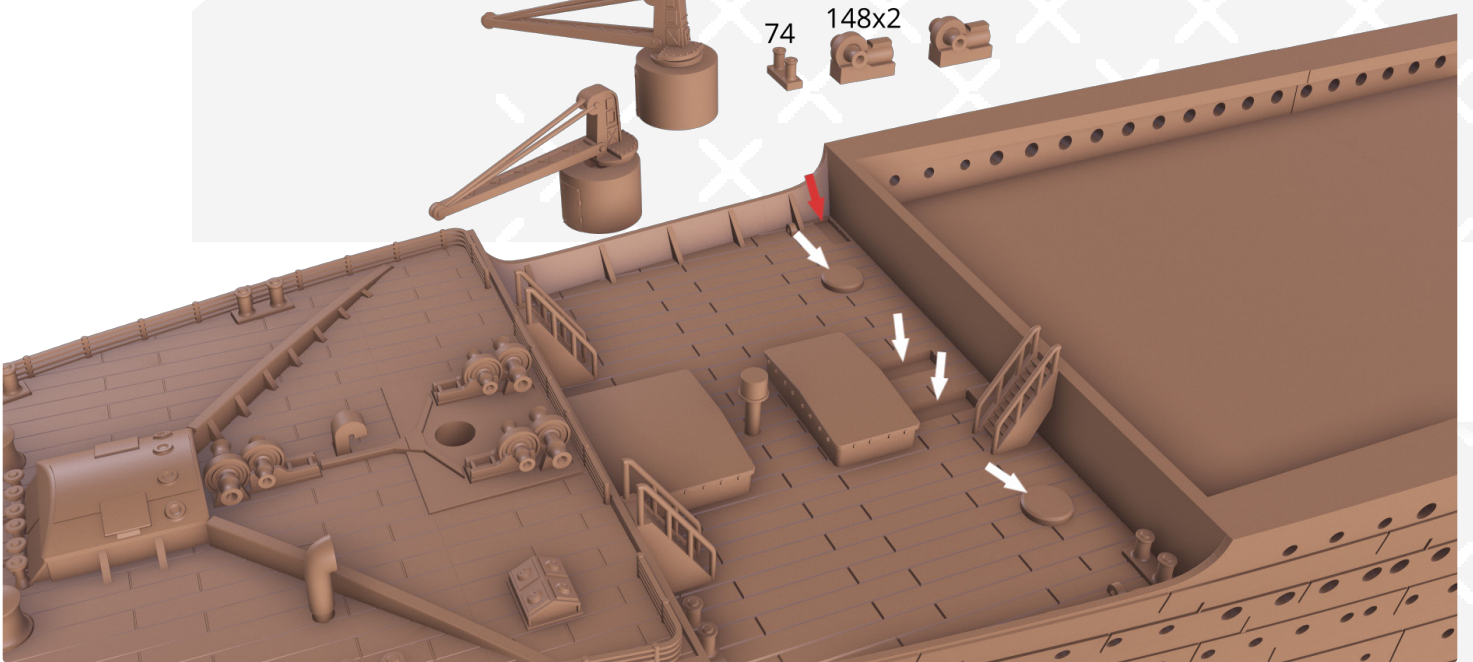

31

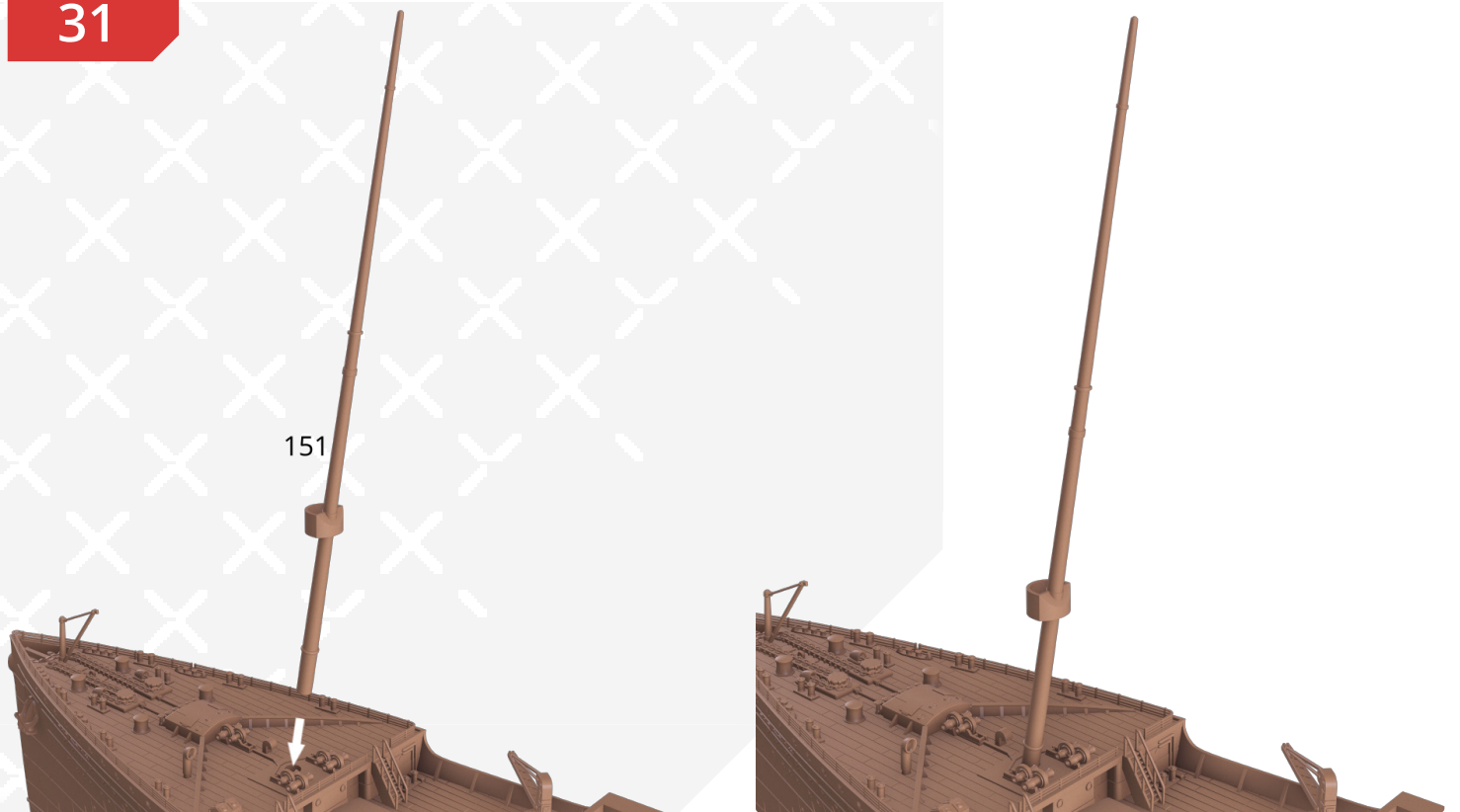

32

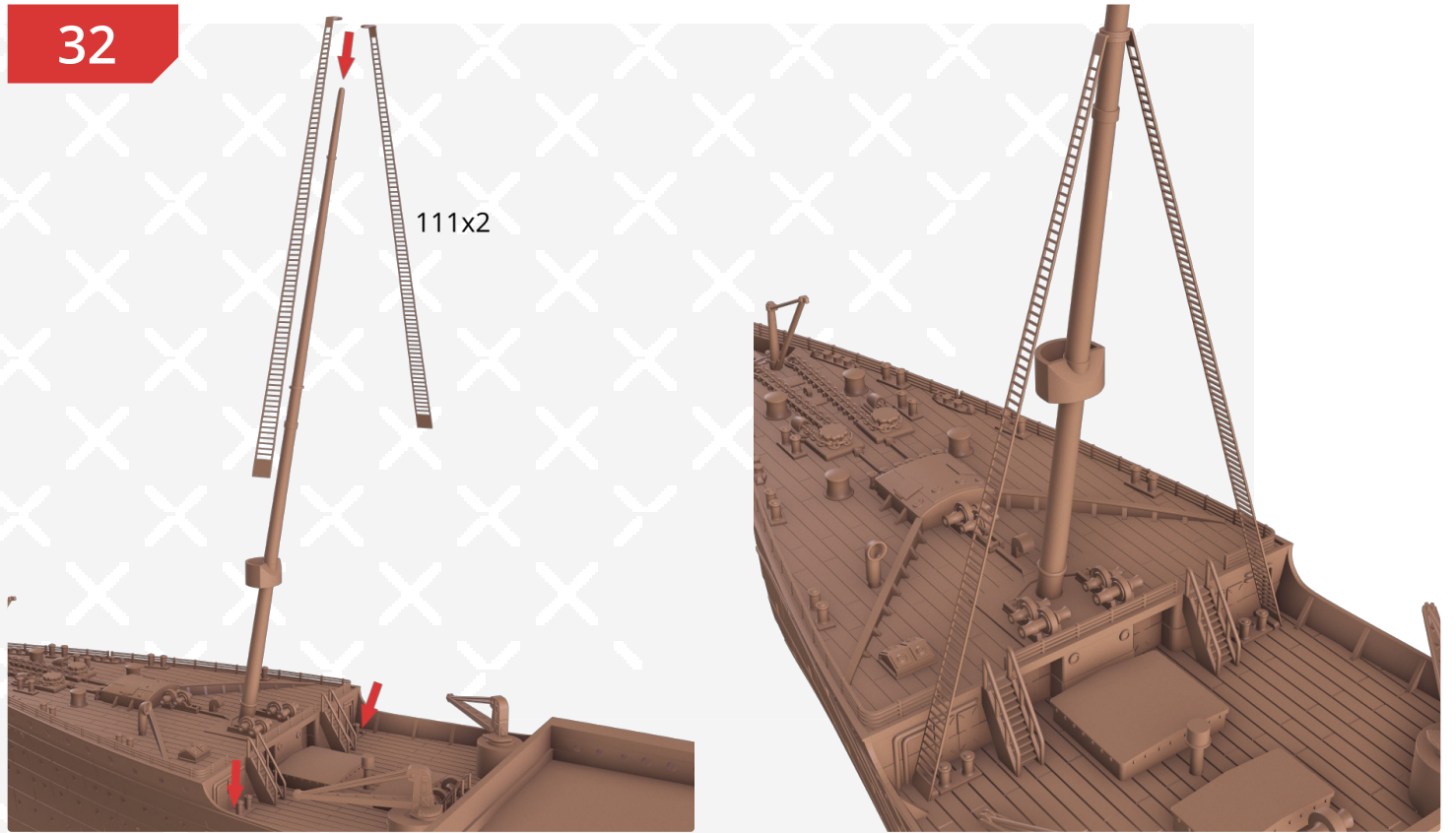

33

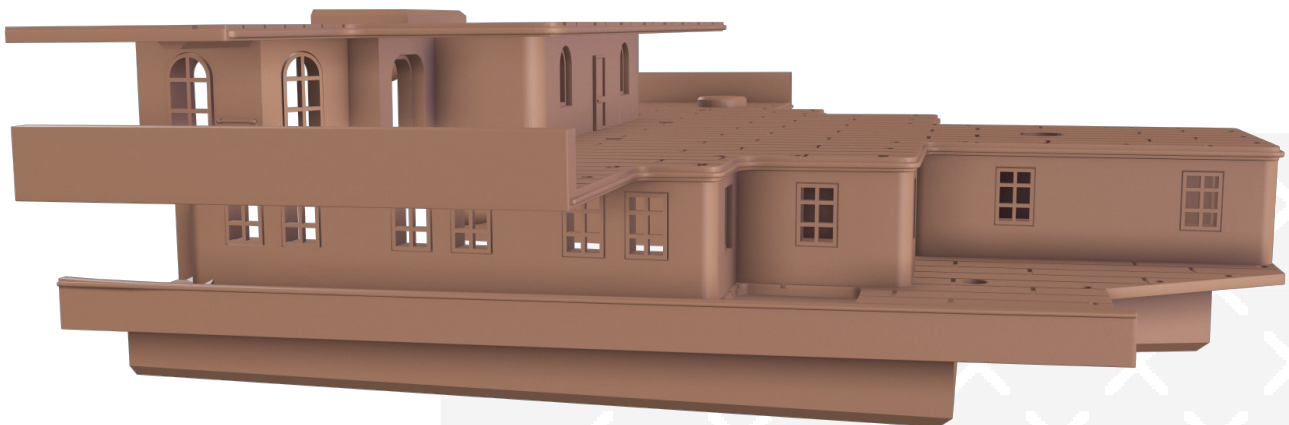
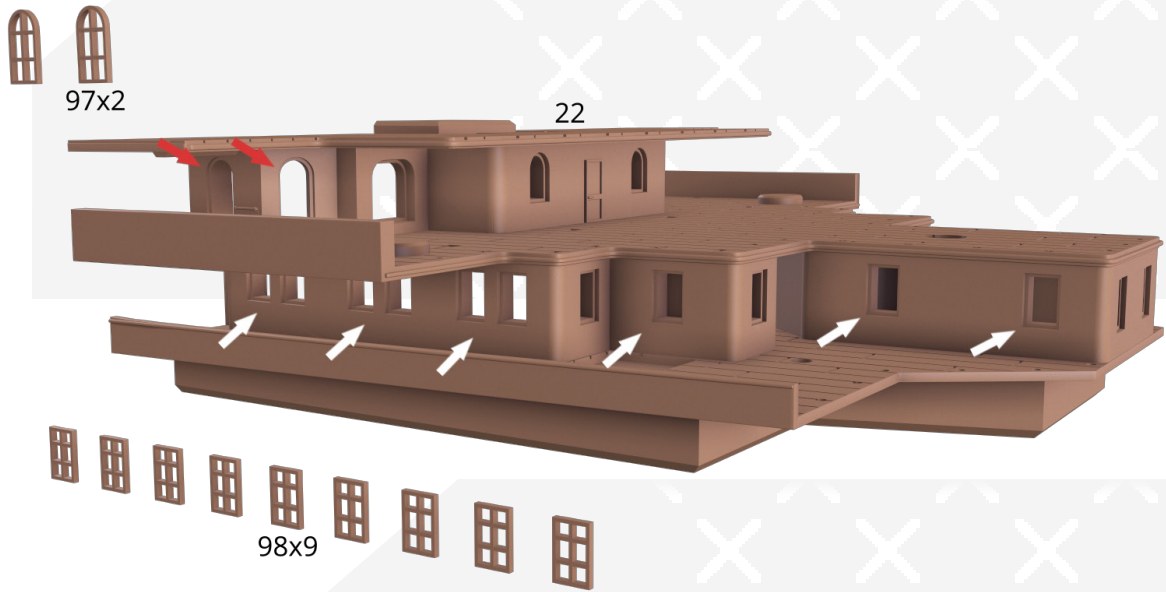

34

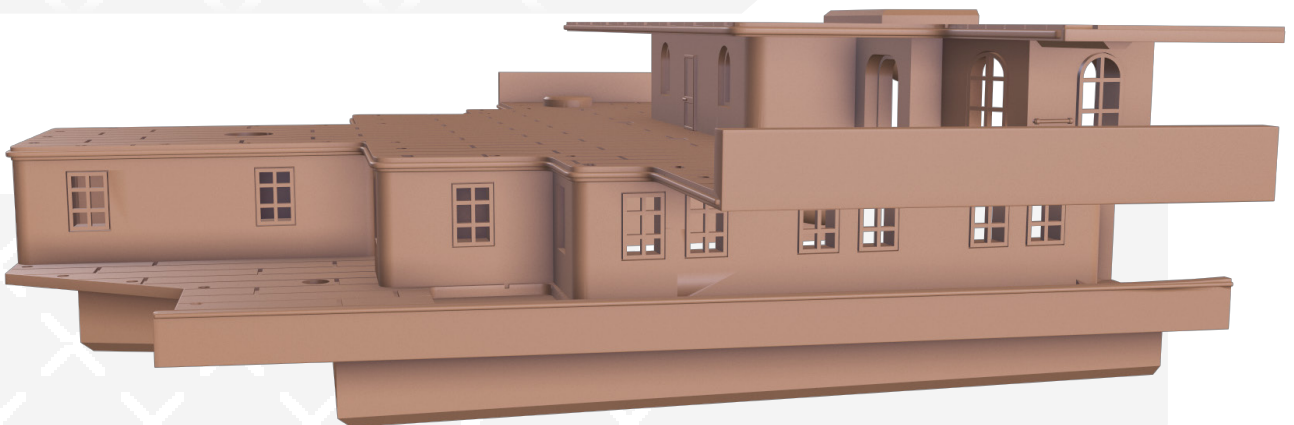
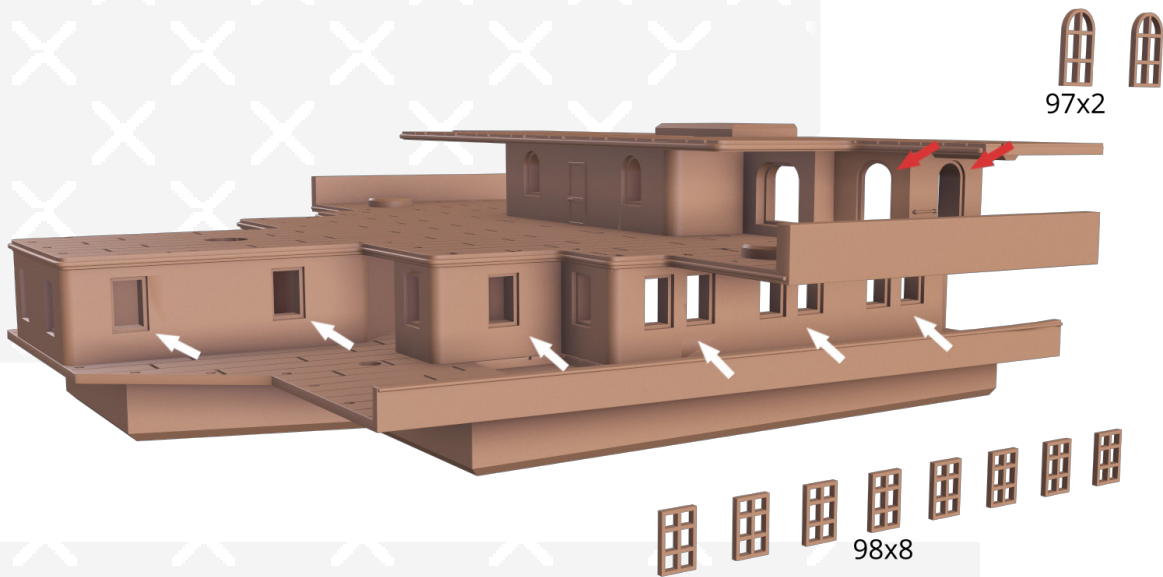

35

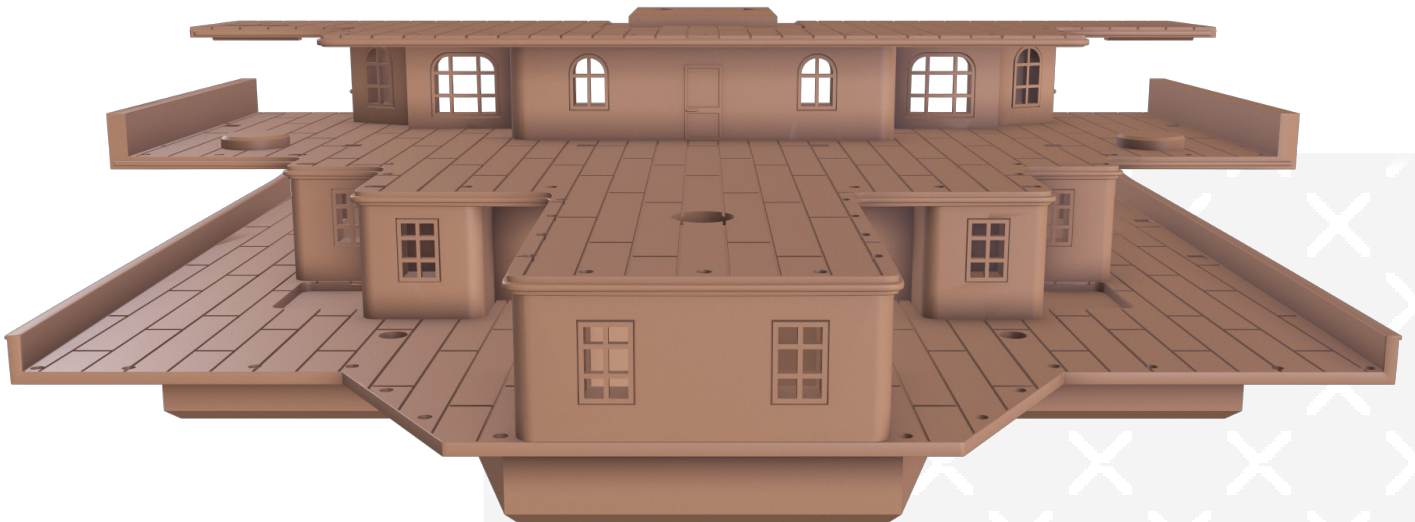
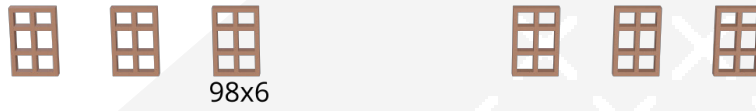
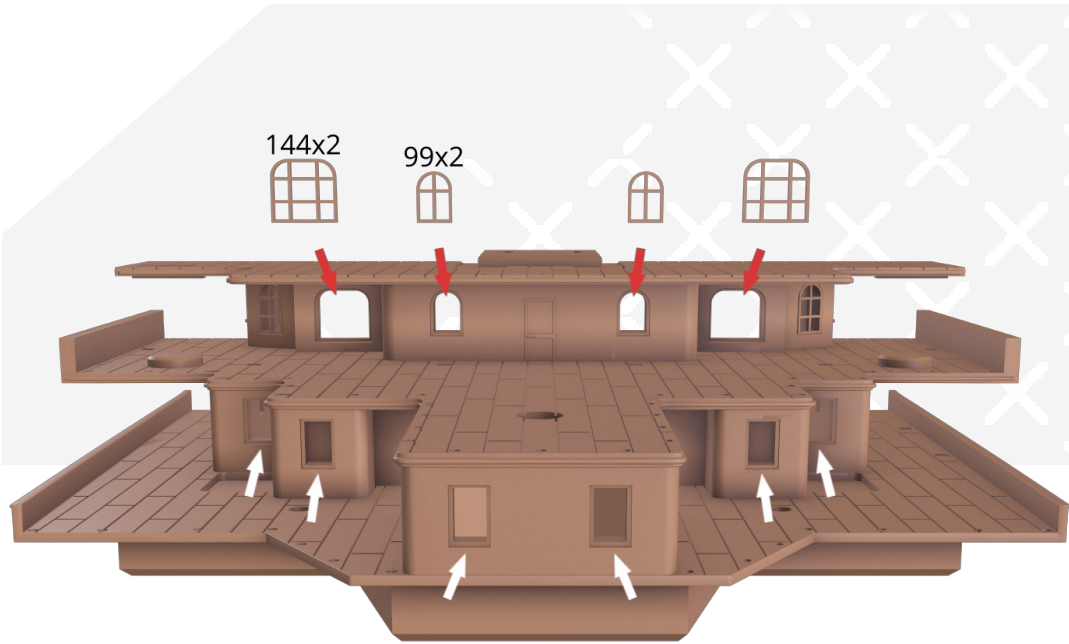

36

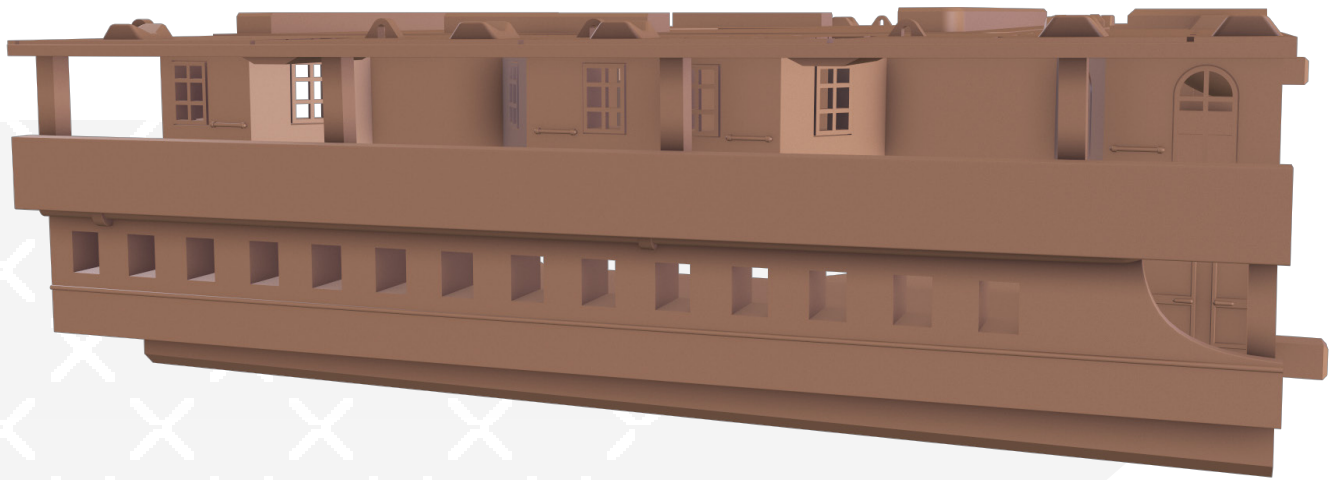
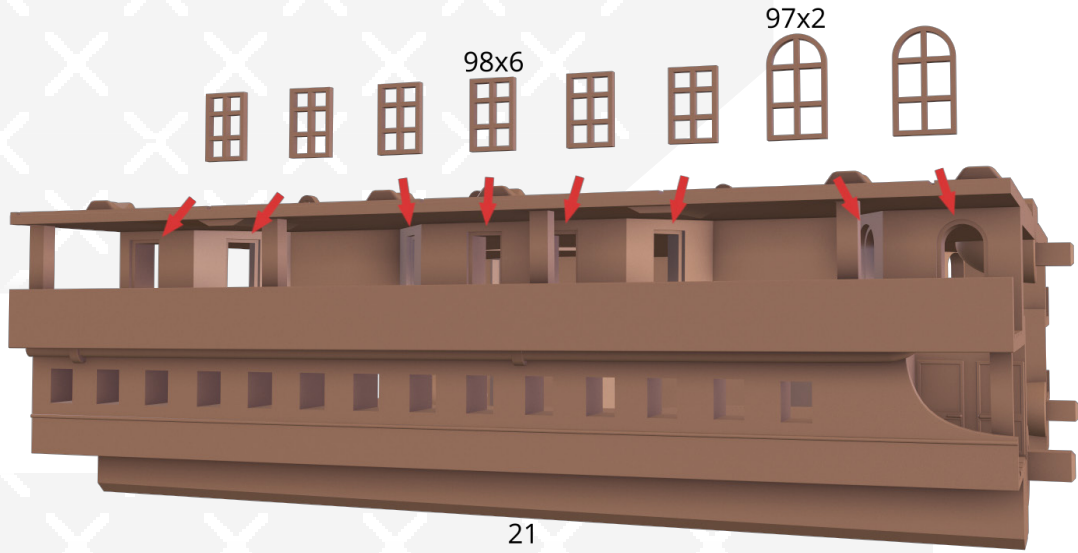

37

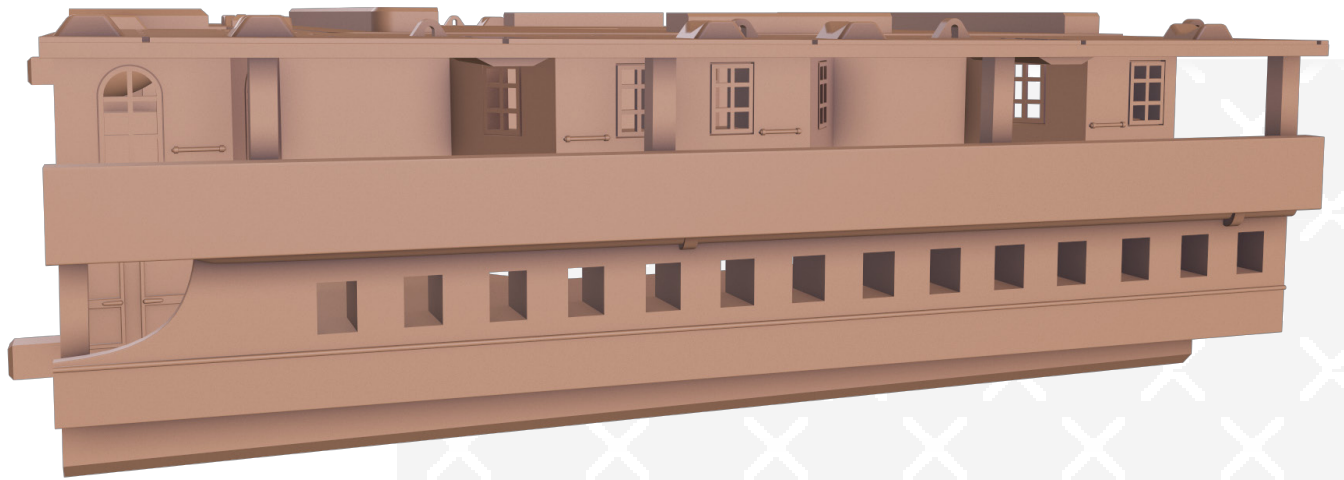
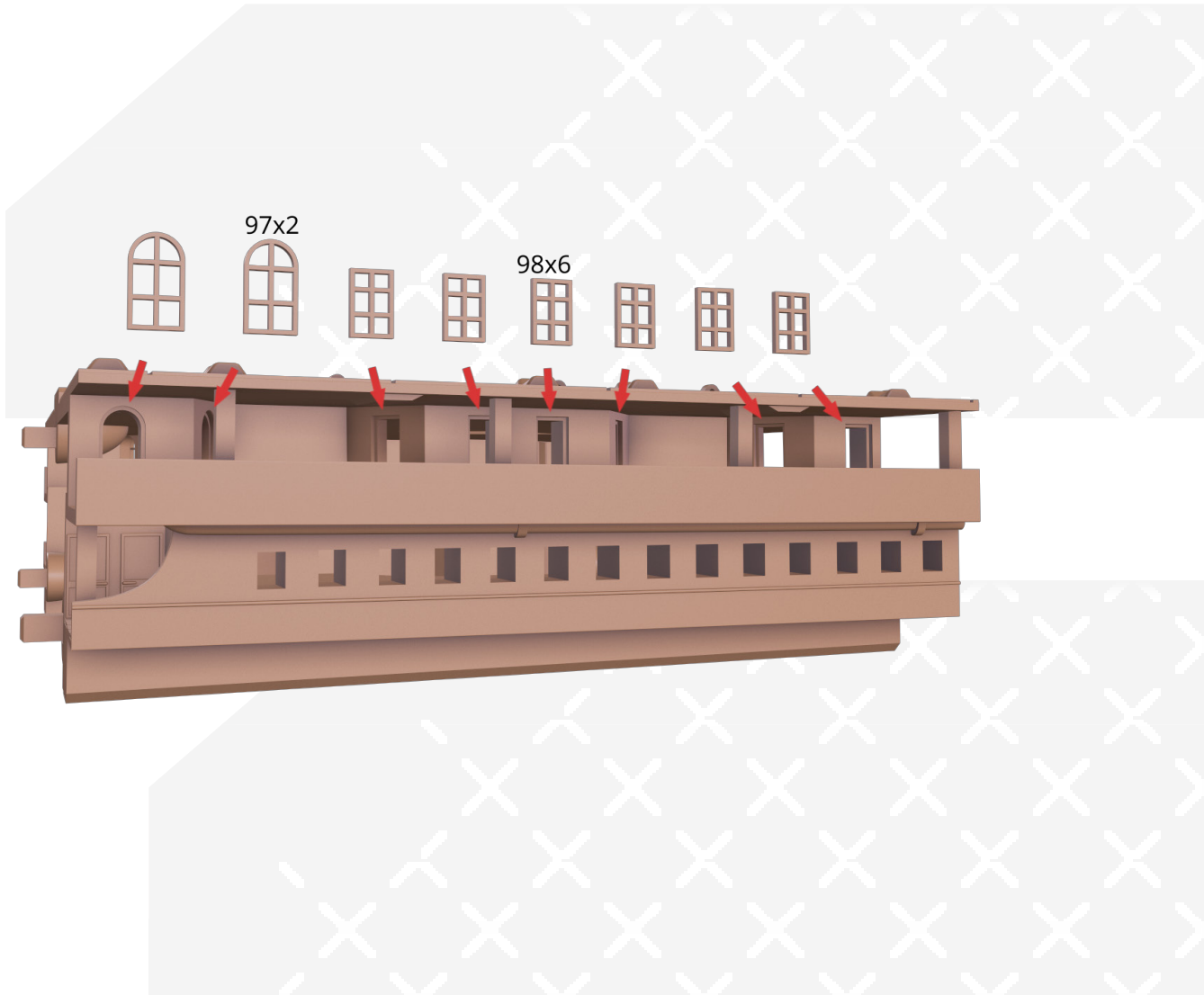

38

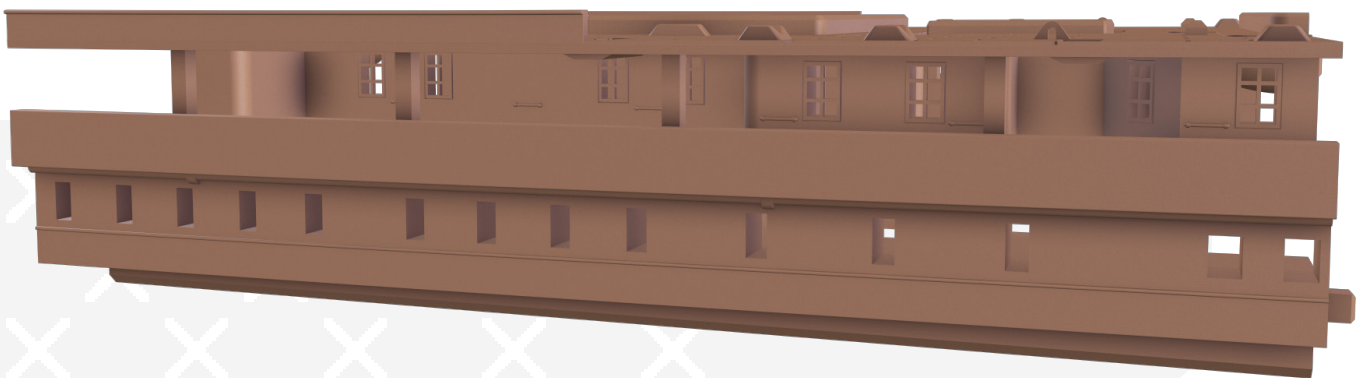
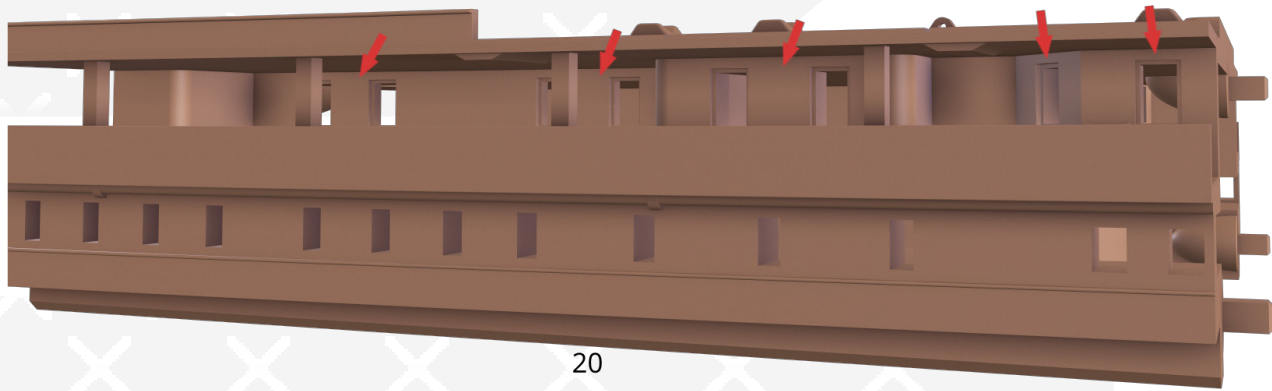

39

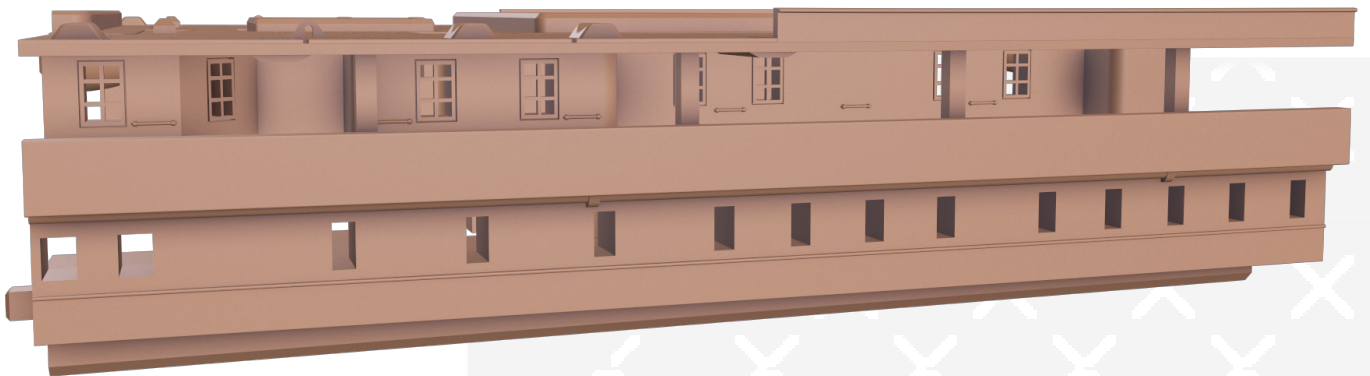
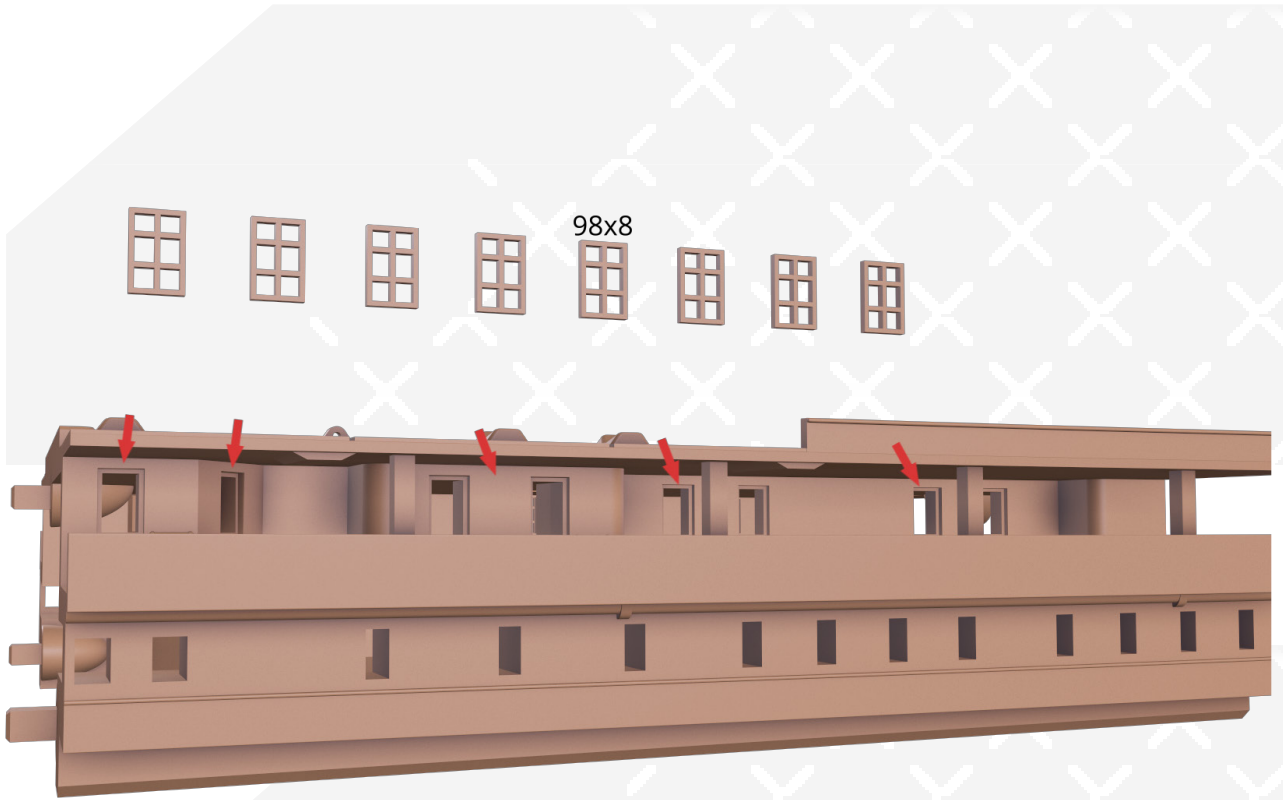

40

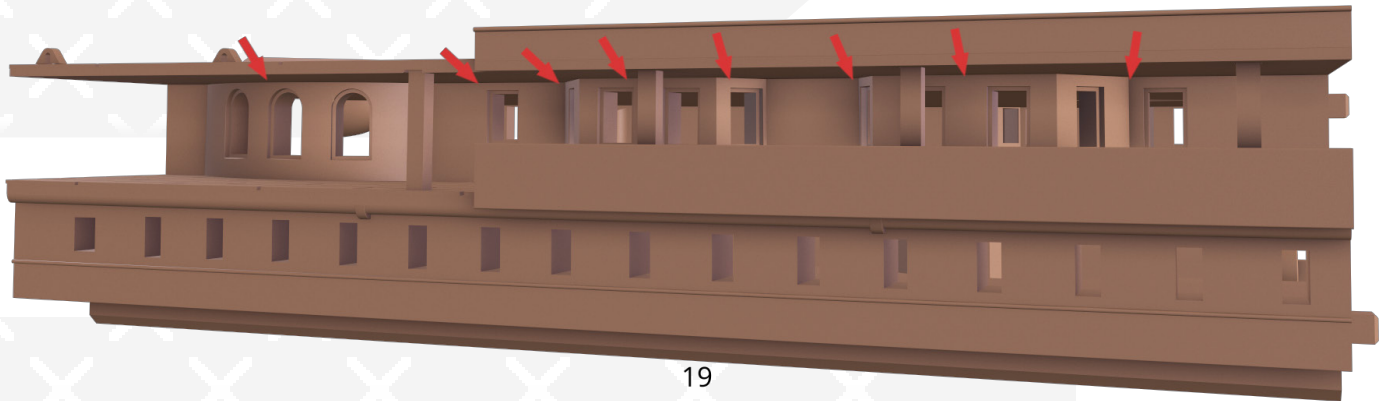

19

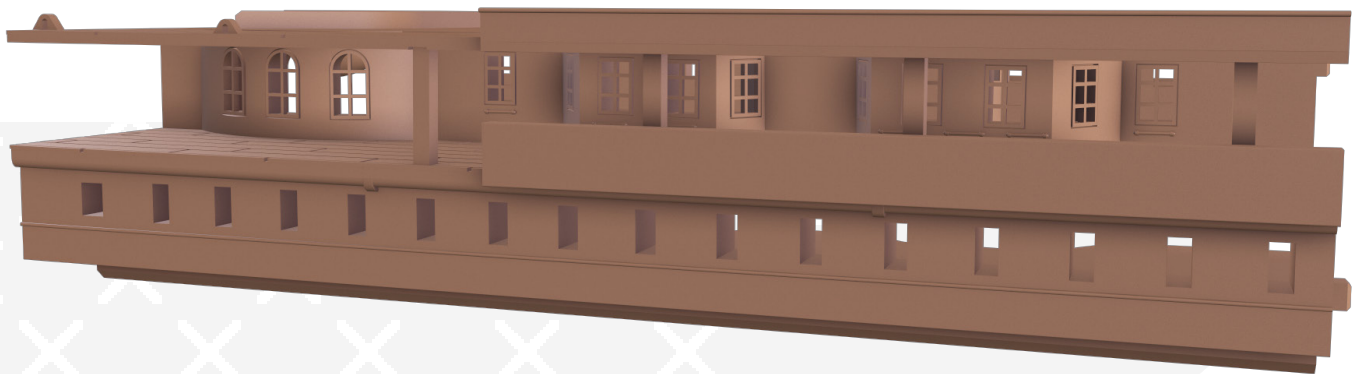

41

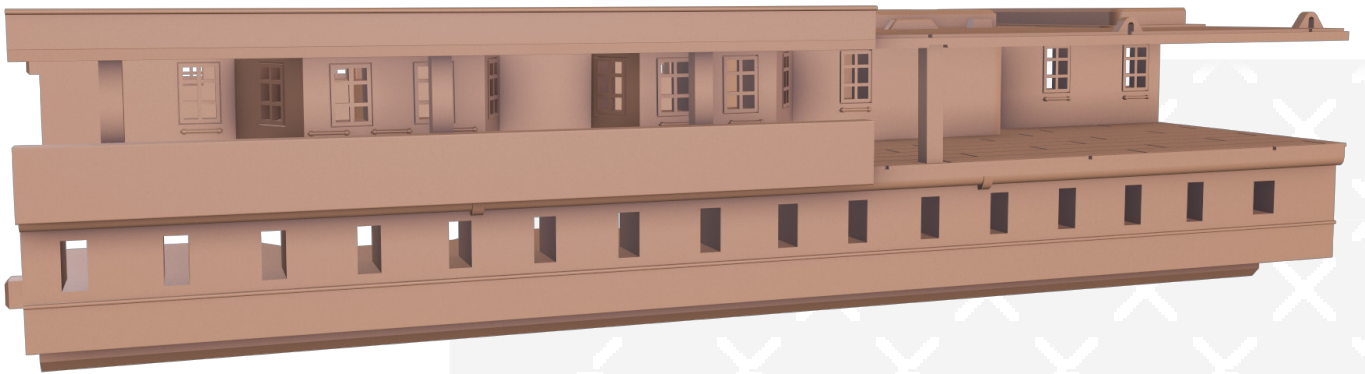
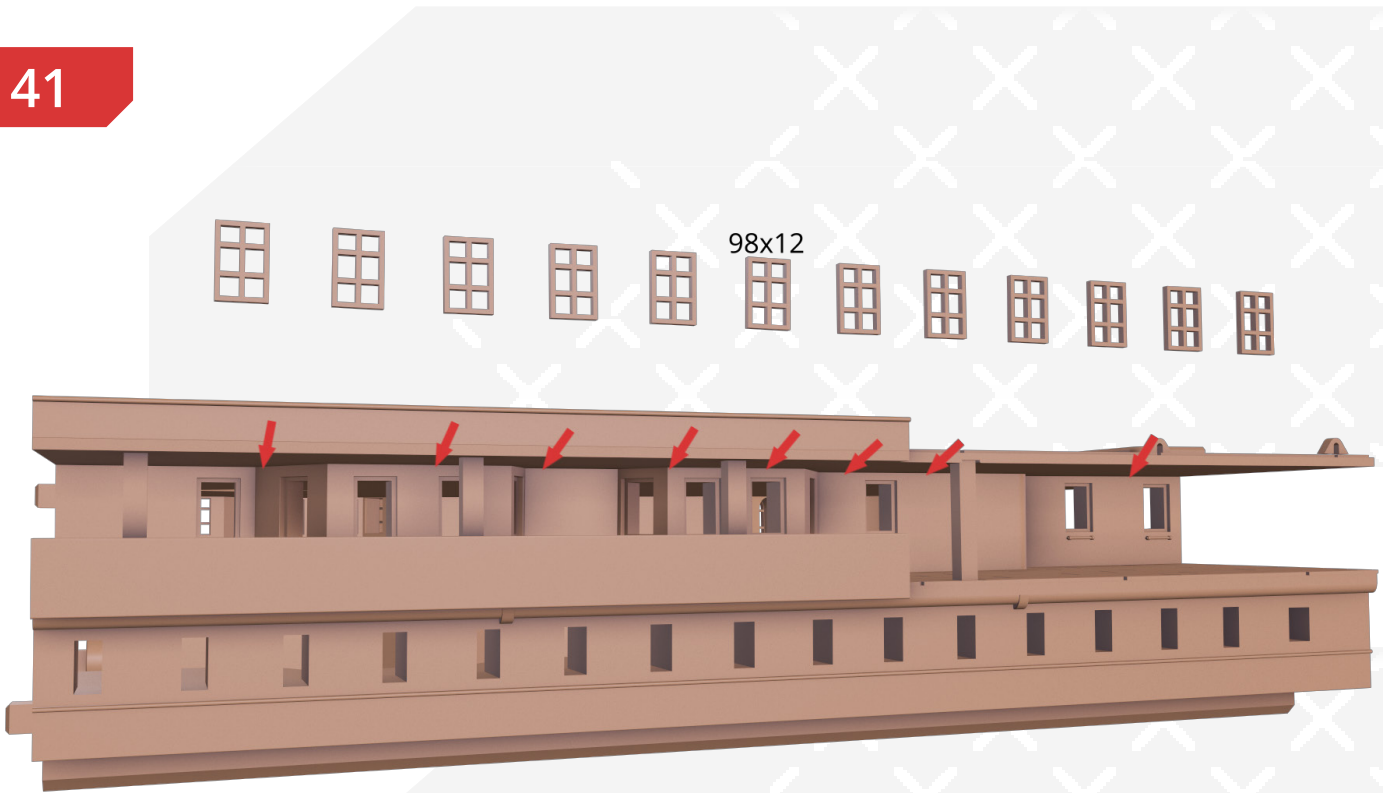

42

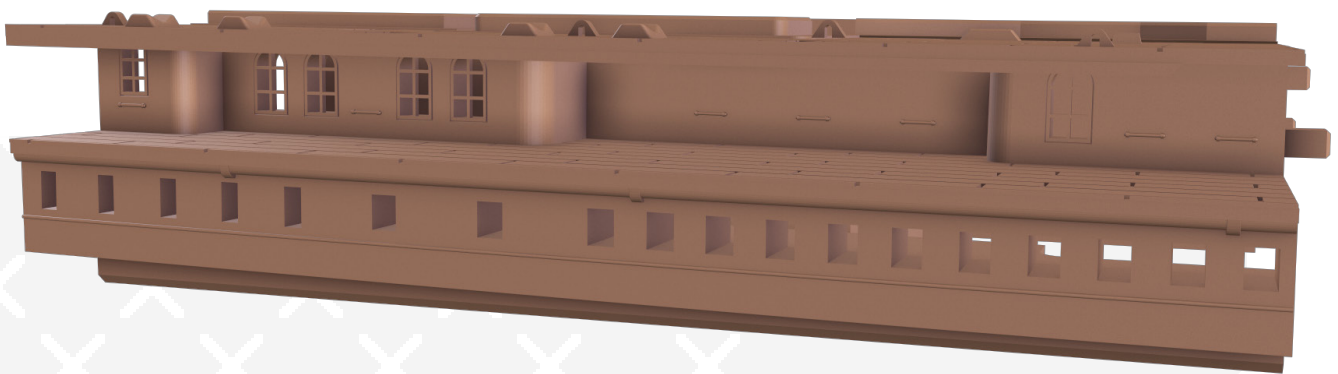
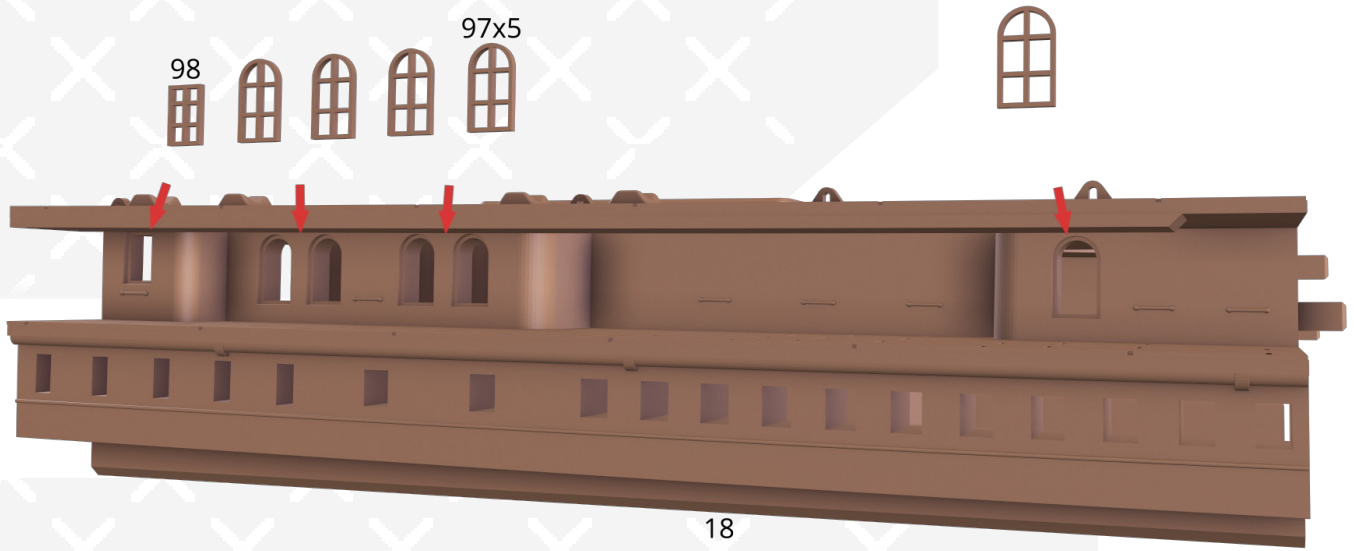

43

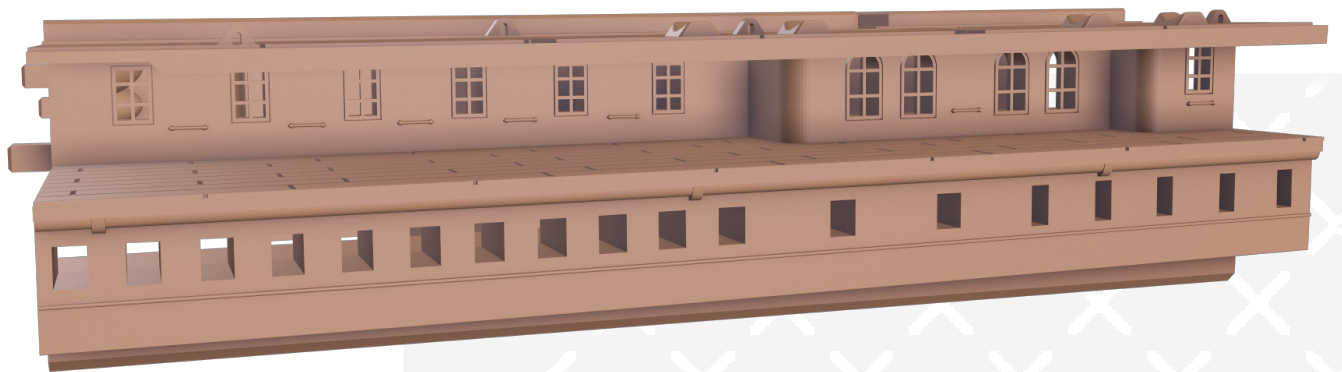
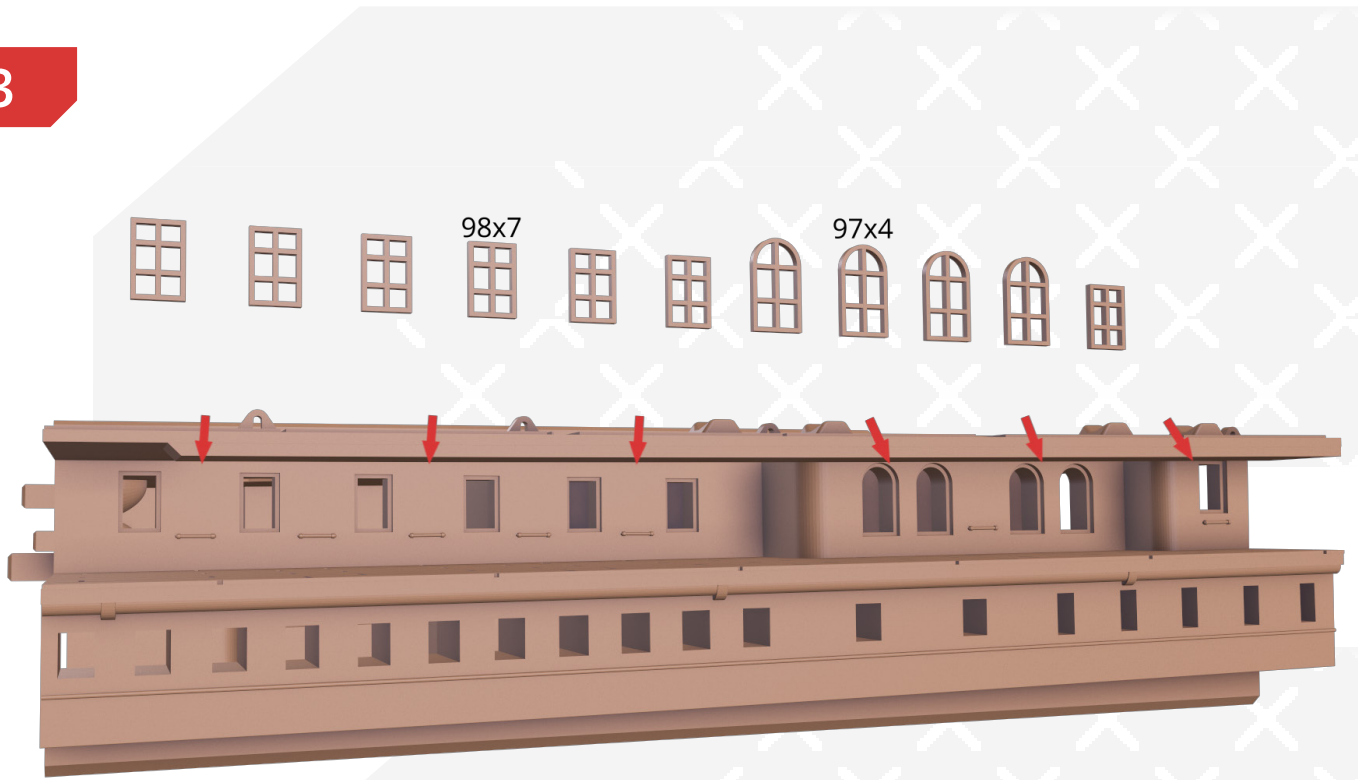

44

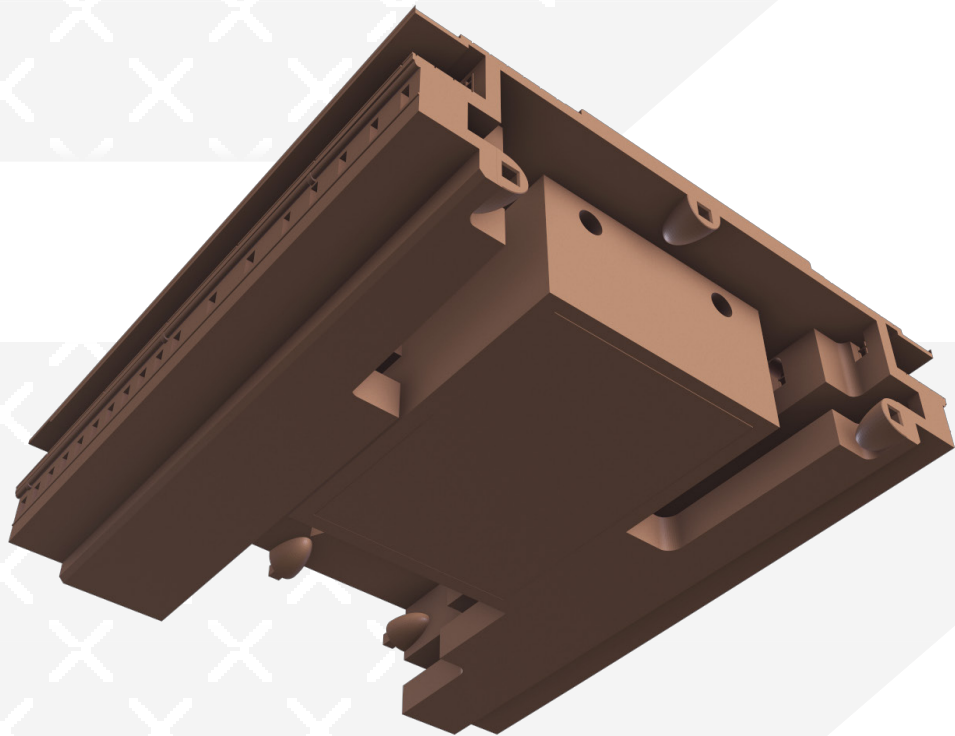
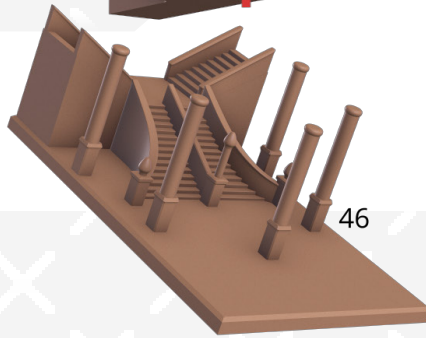
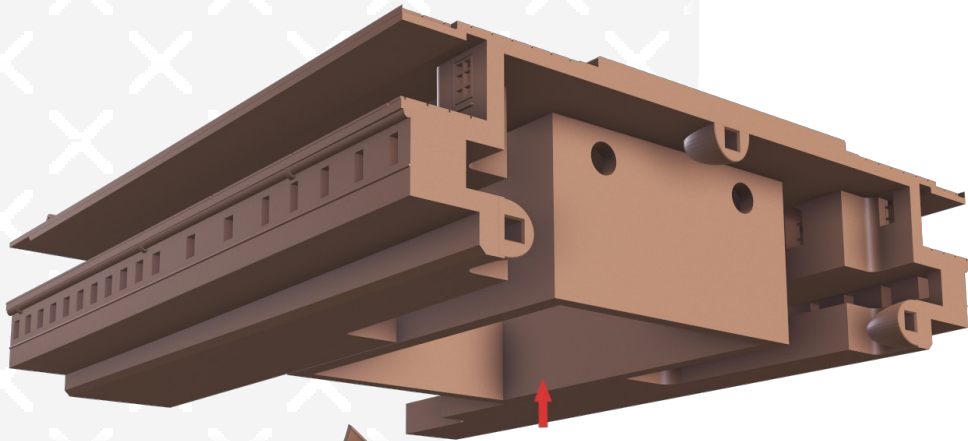

45

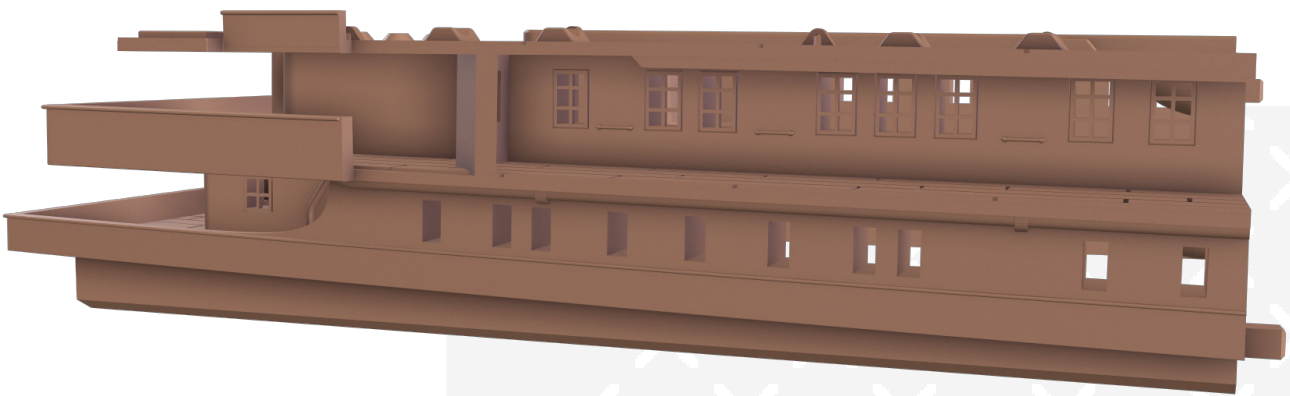
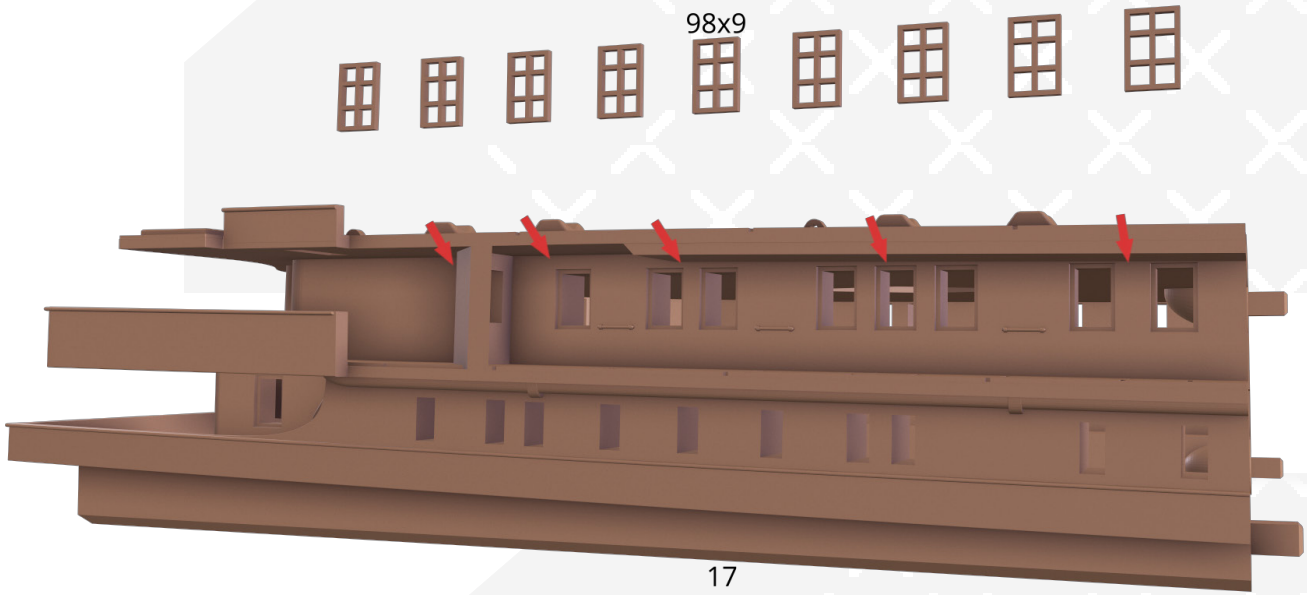

46

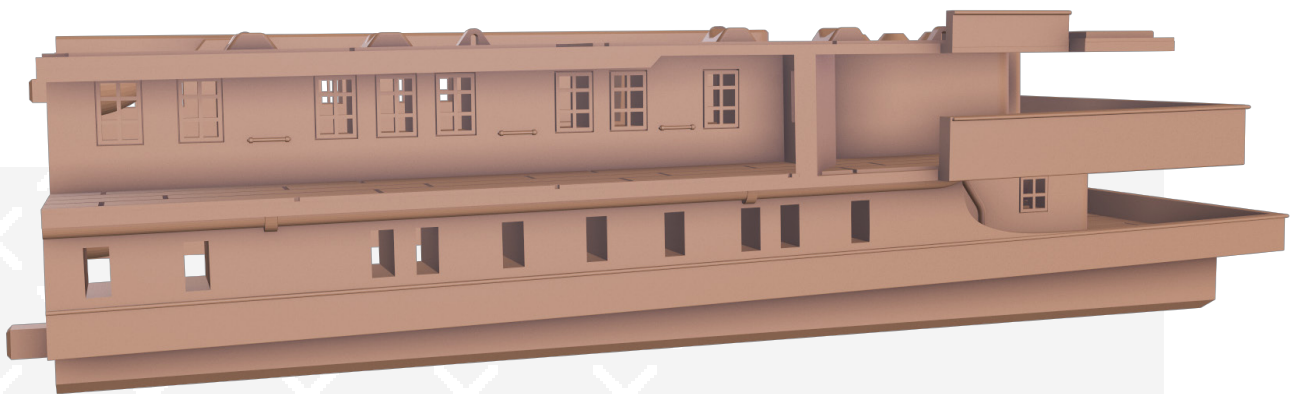
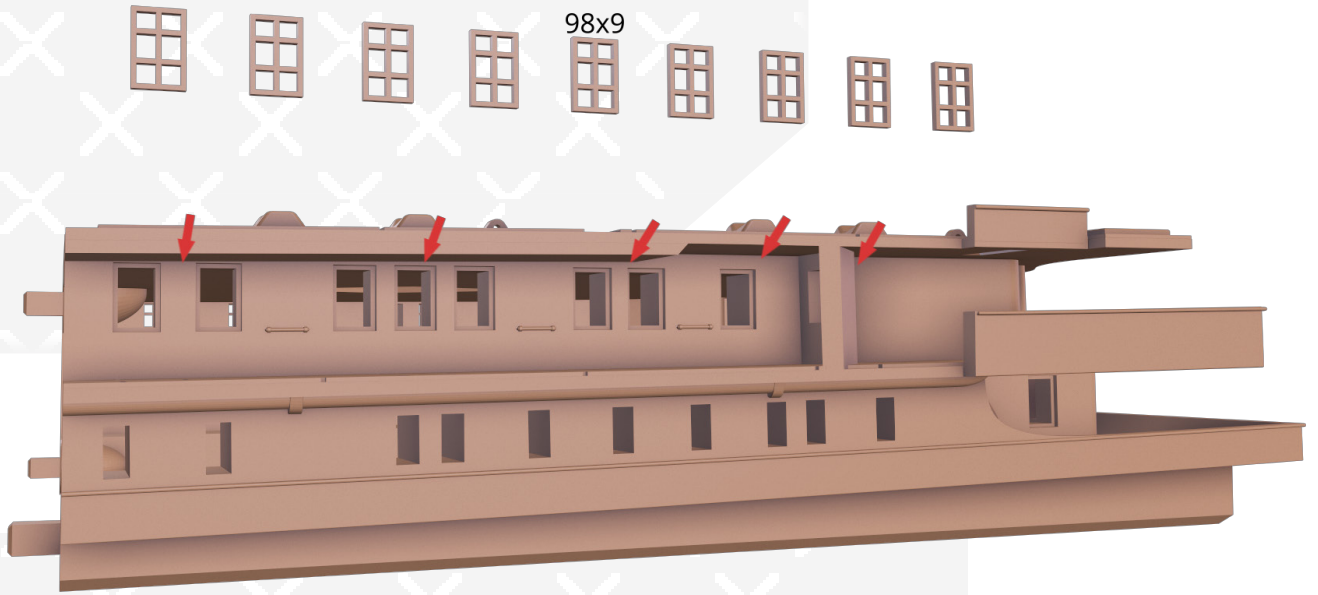

47

98x18

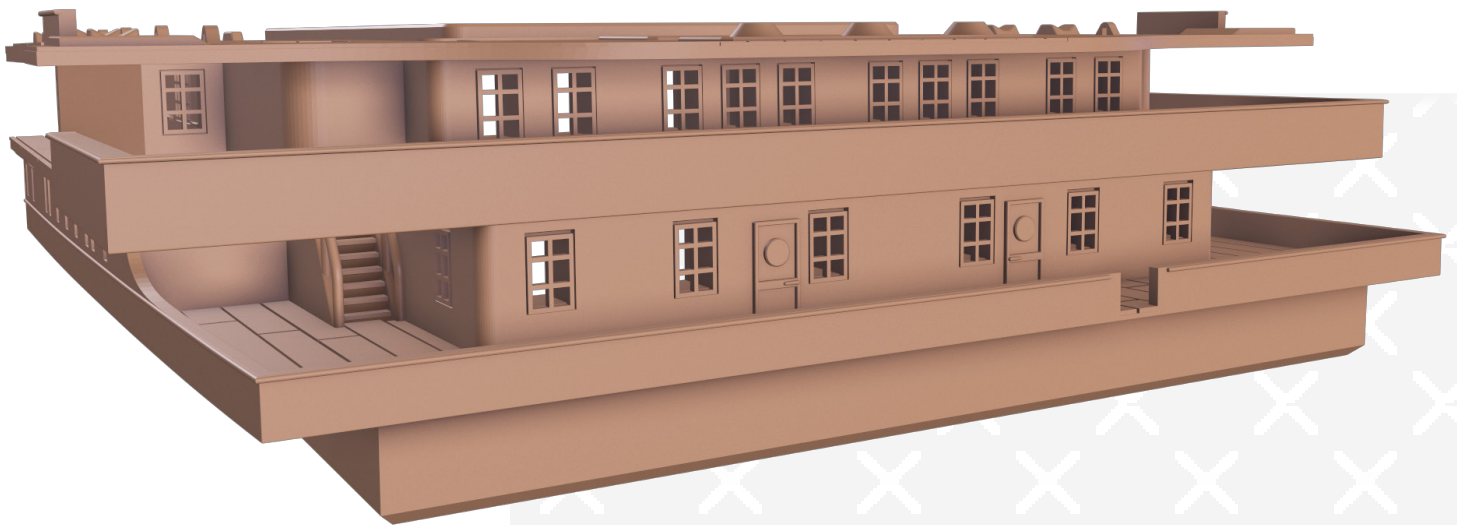
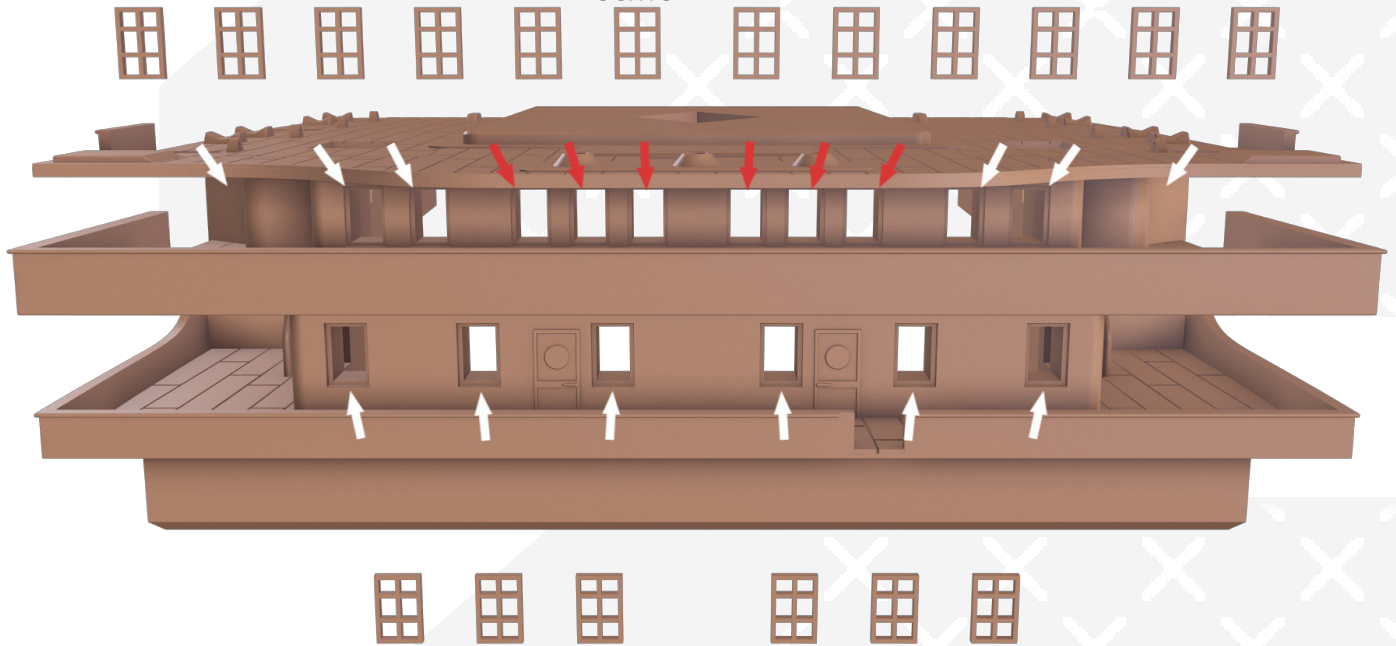

48

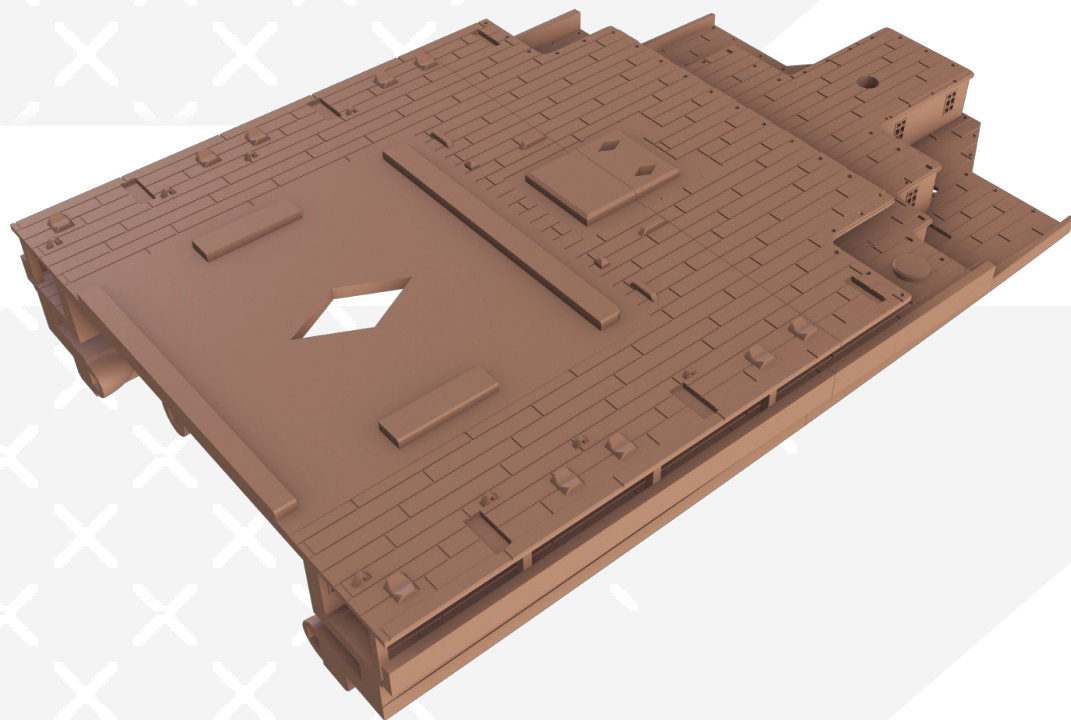
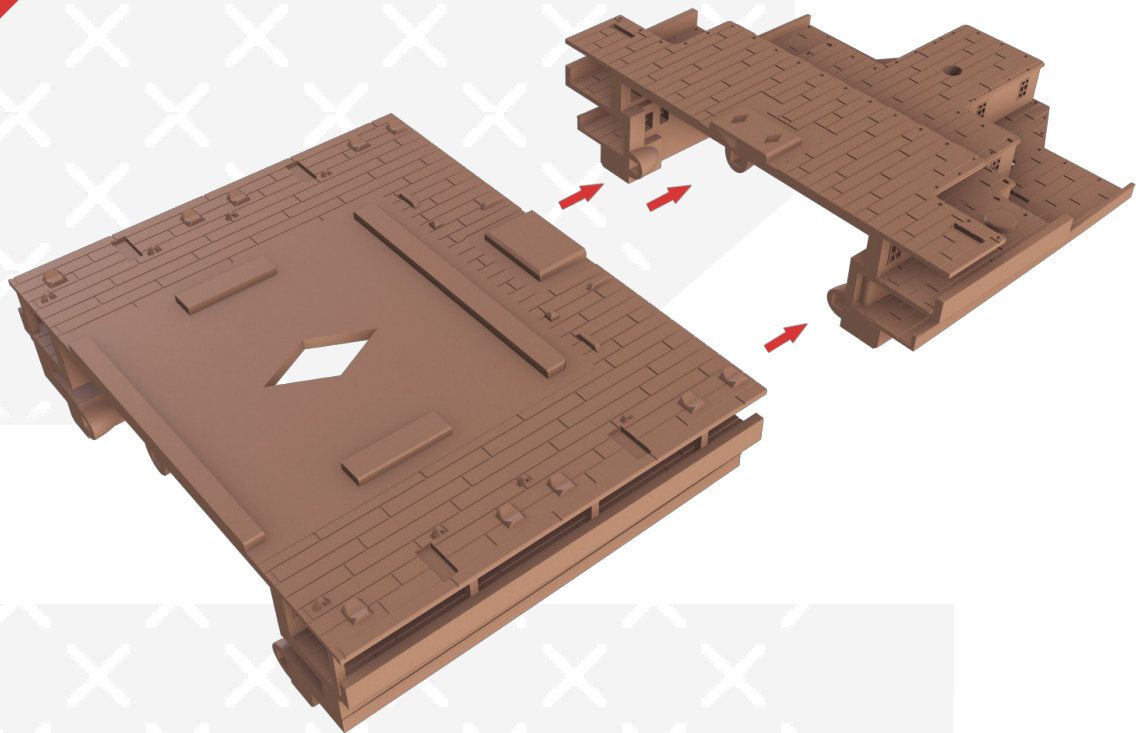

49

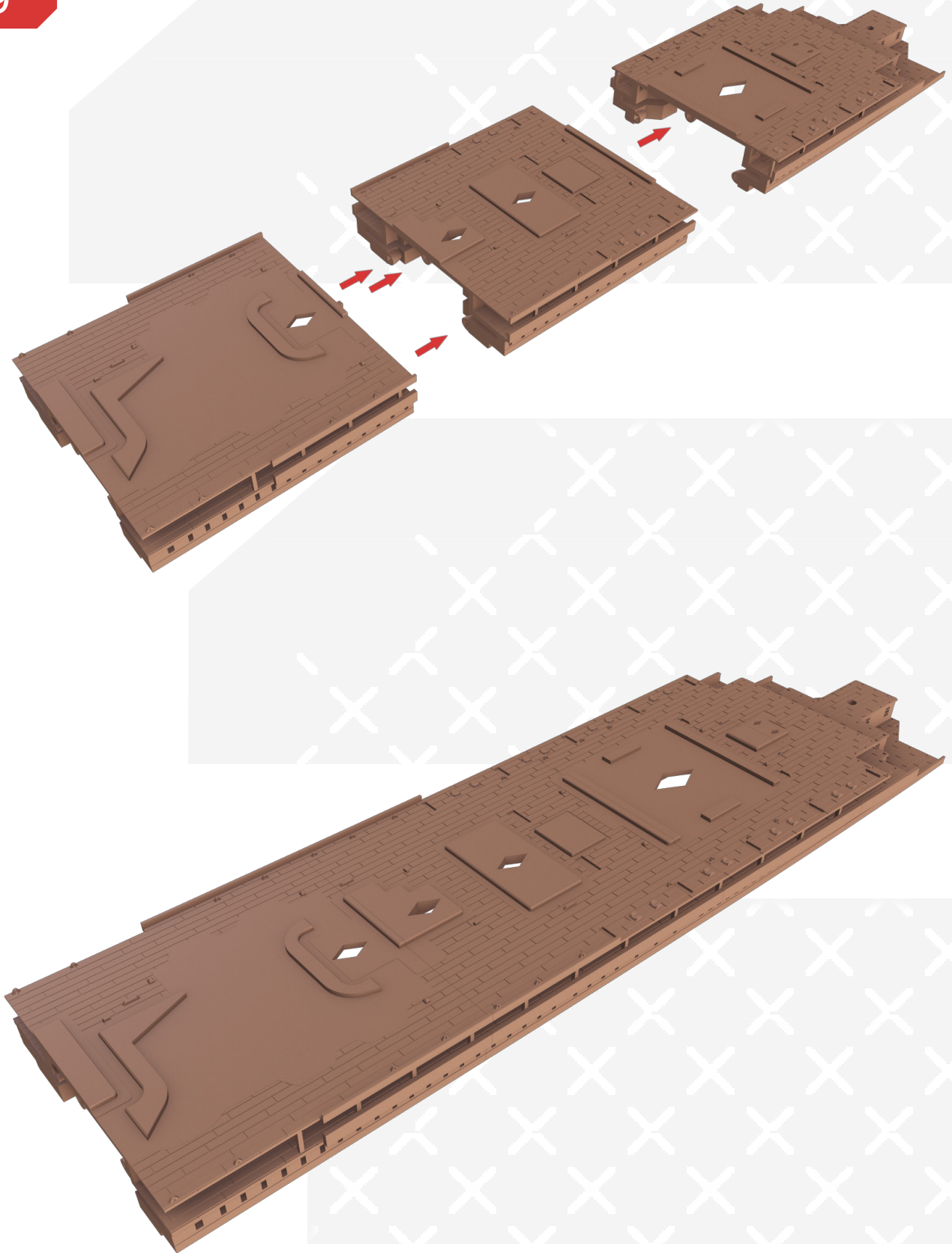

50

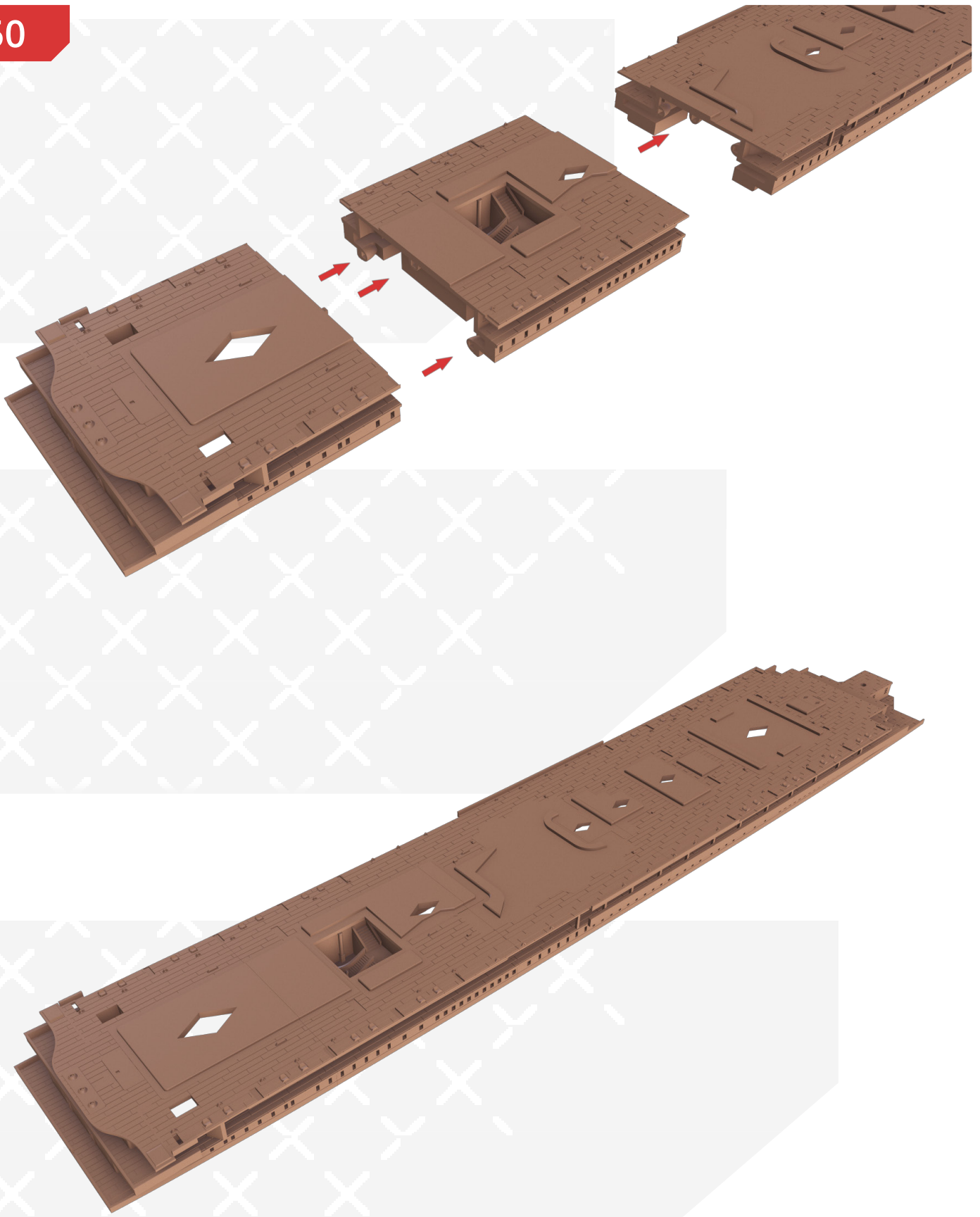

51

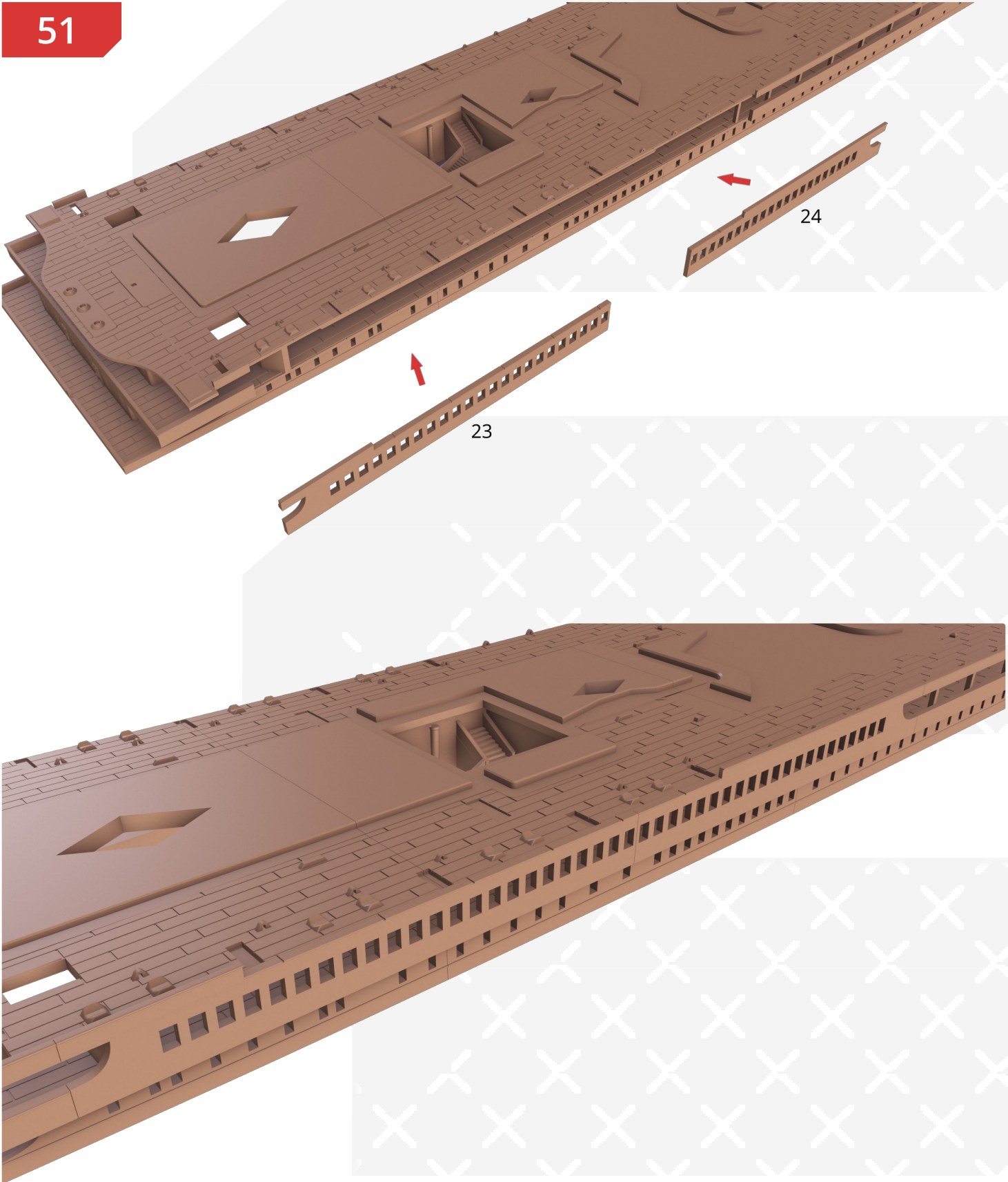

52

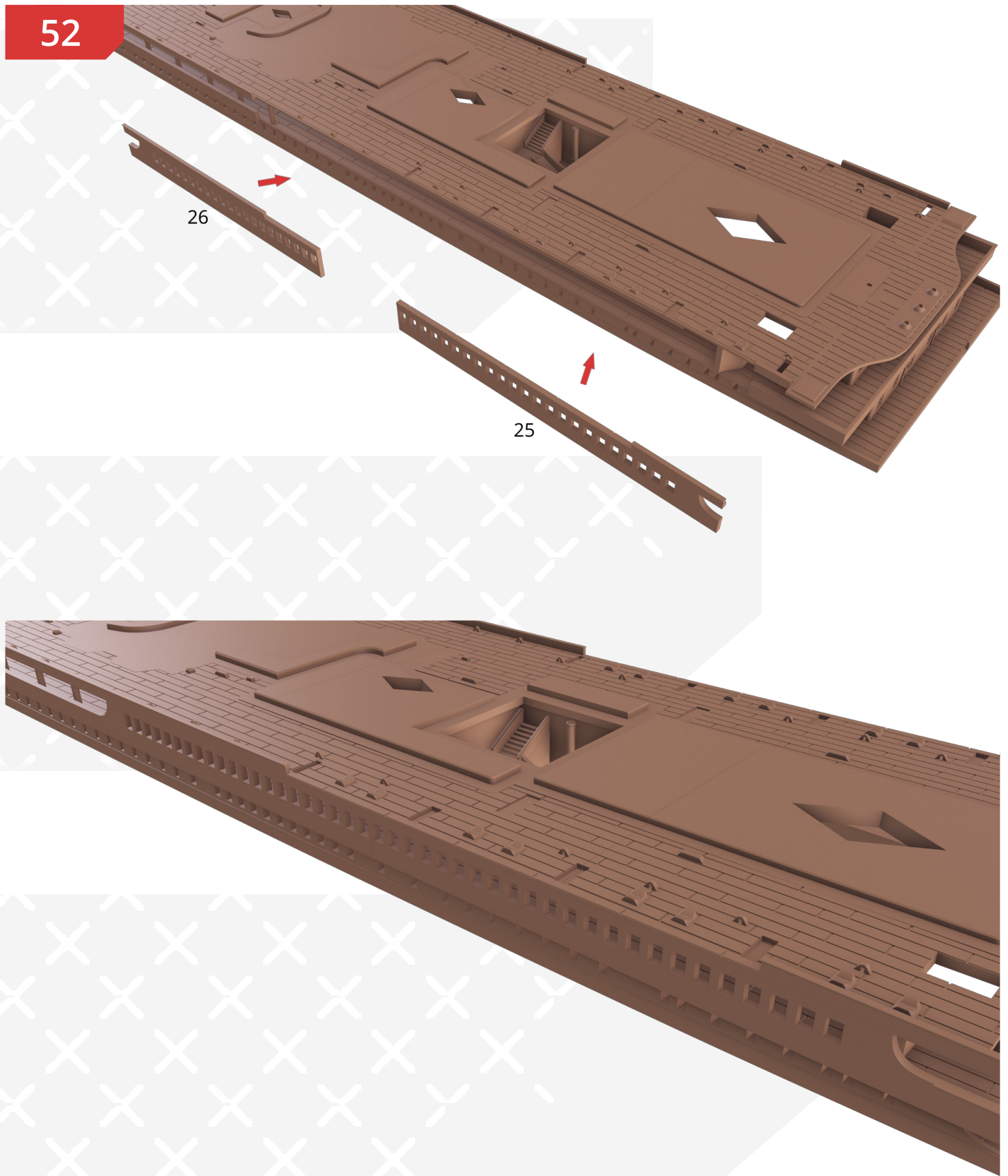

53

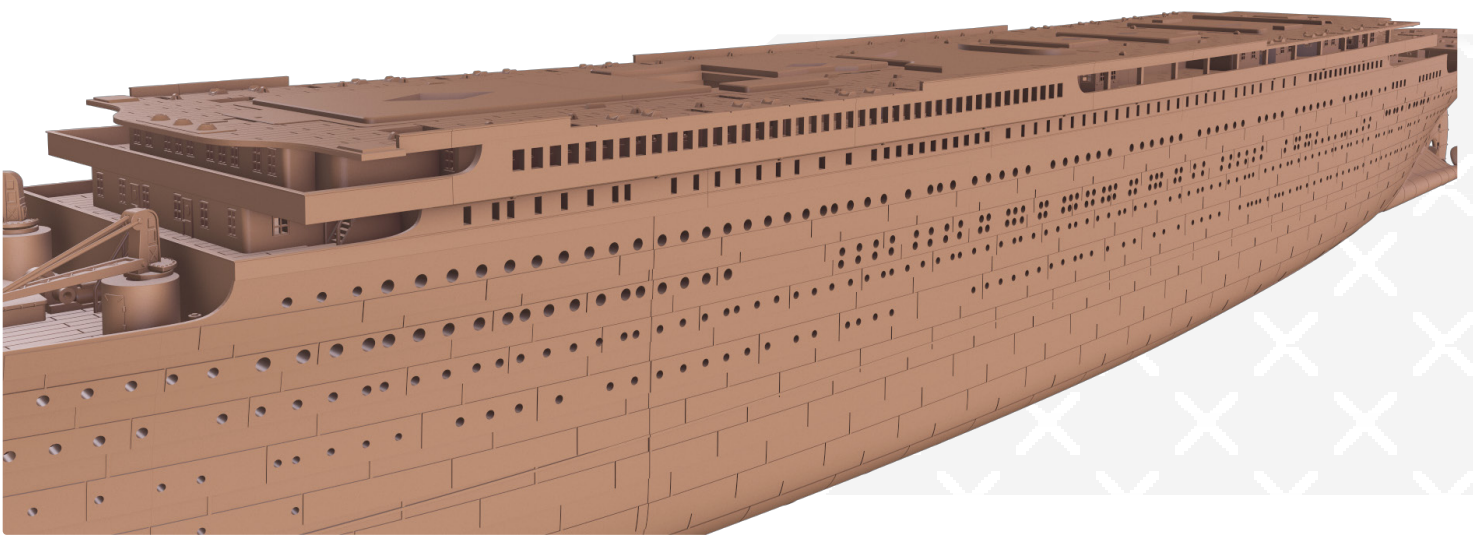
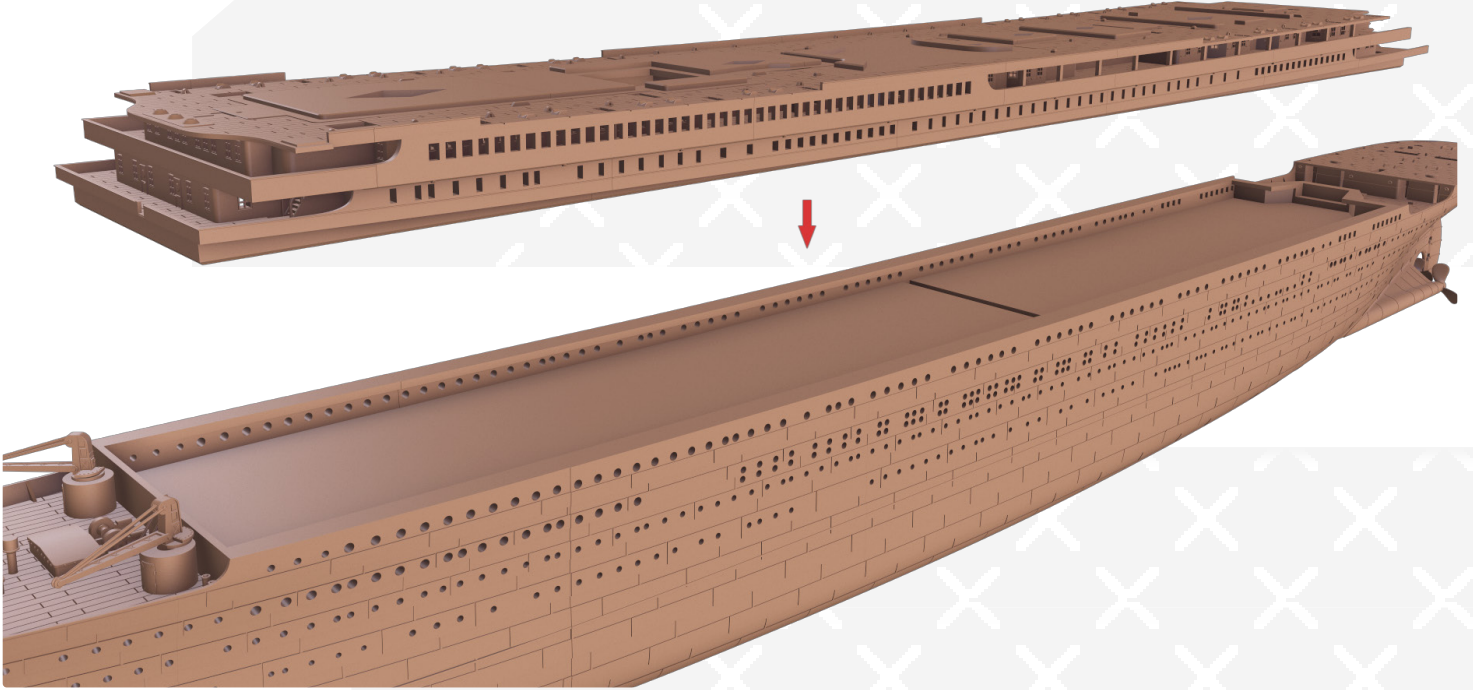

54

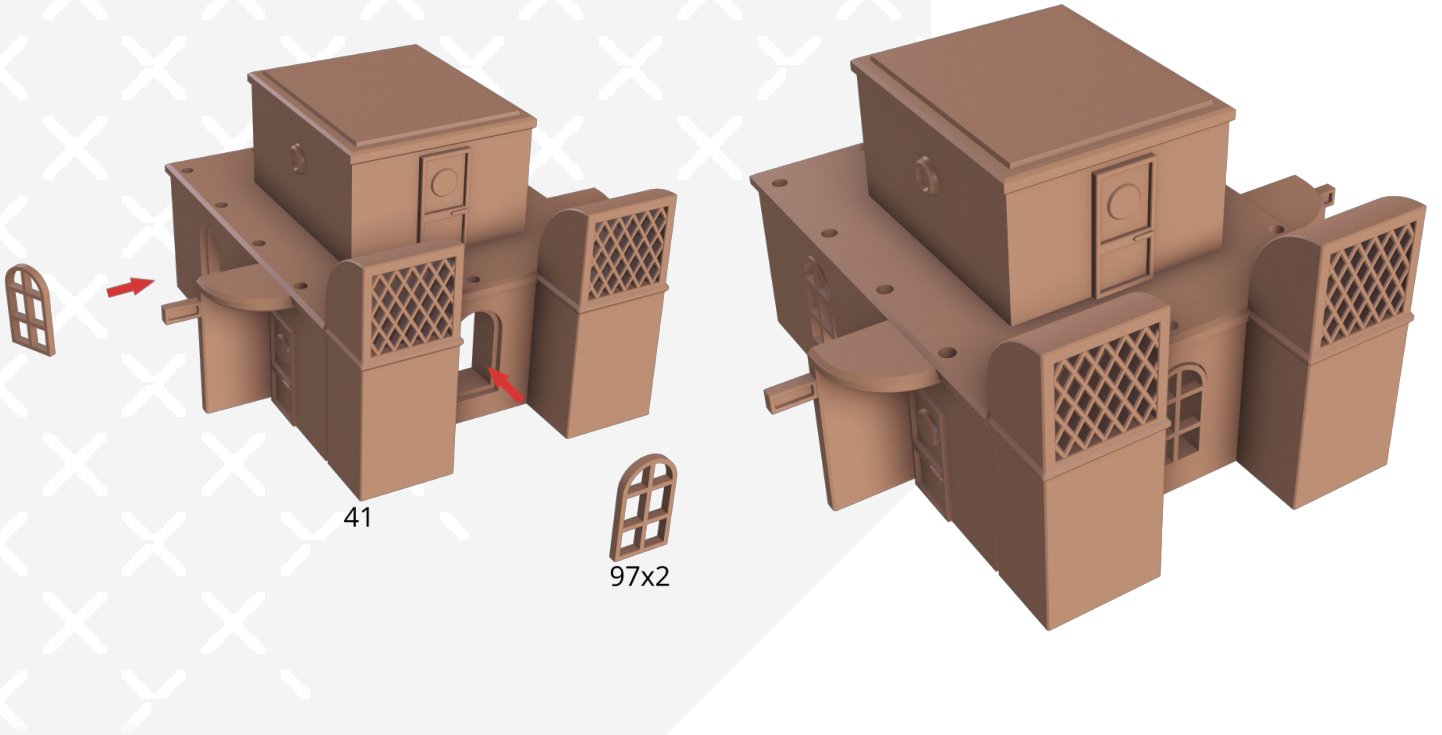

55

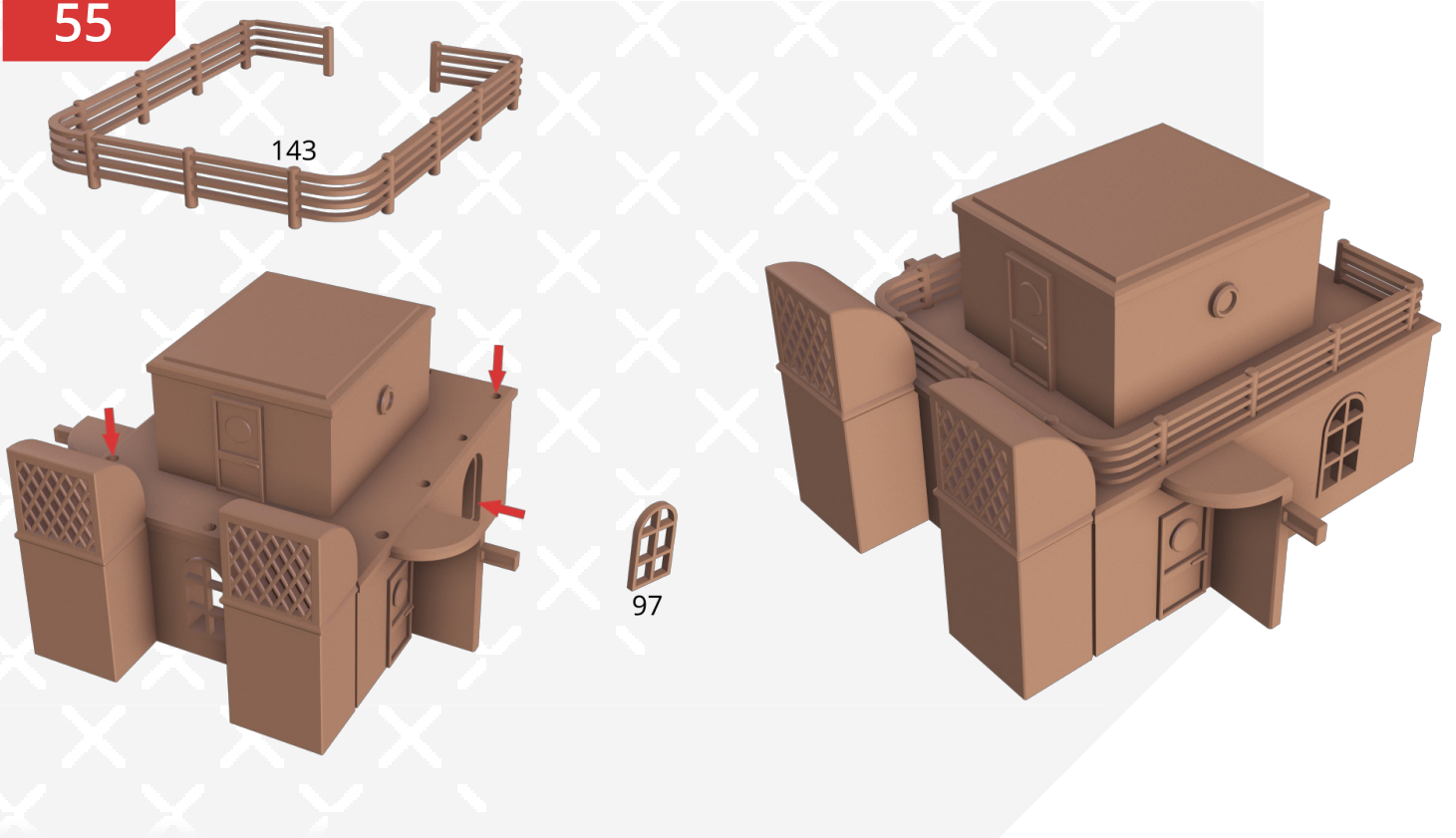

56

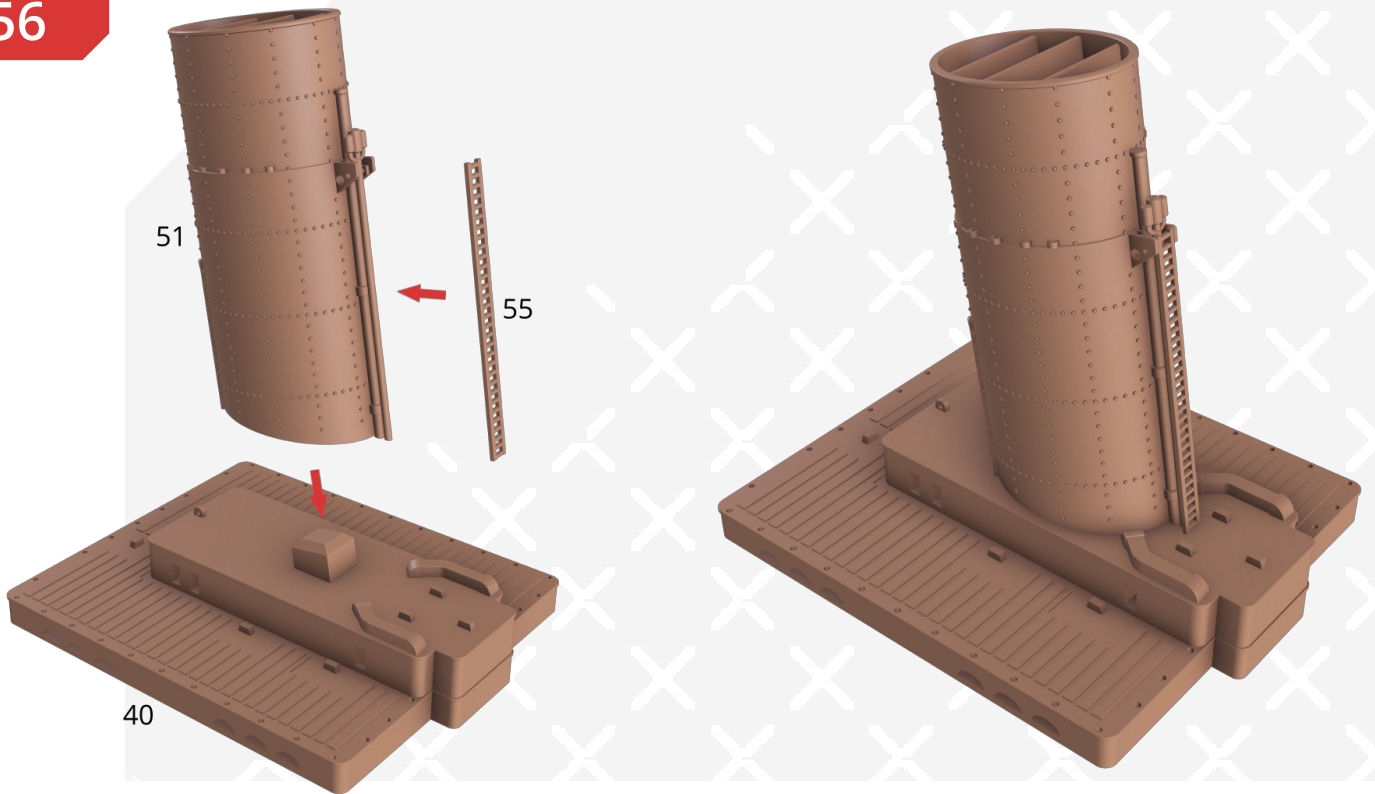

57

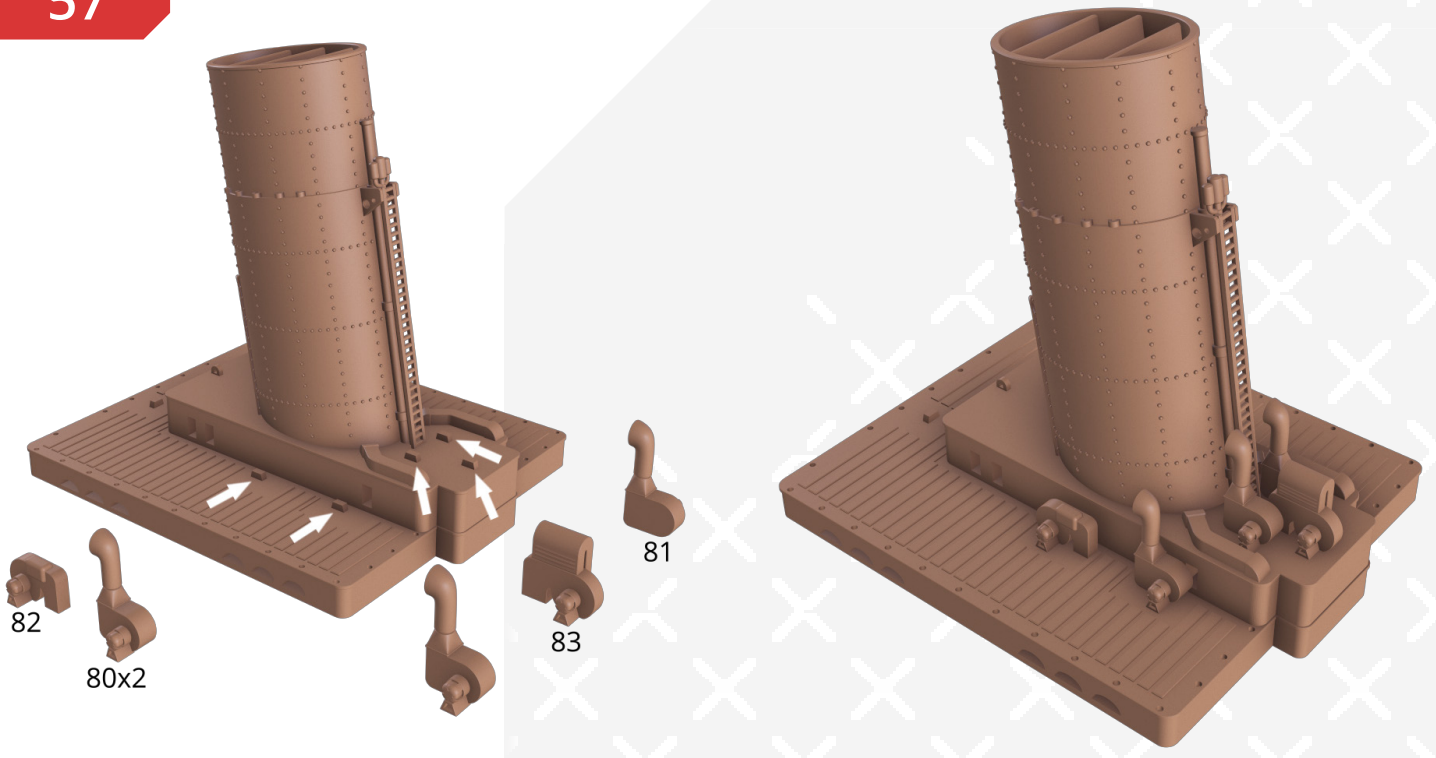

58

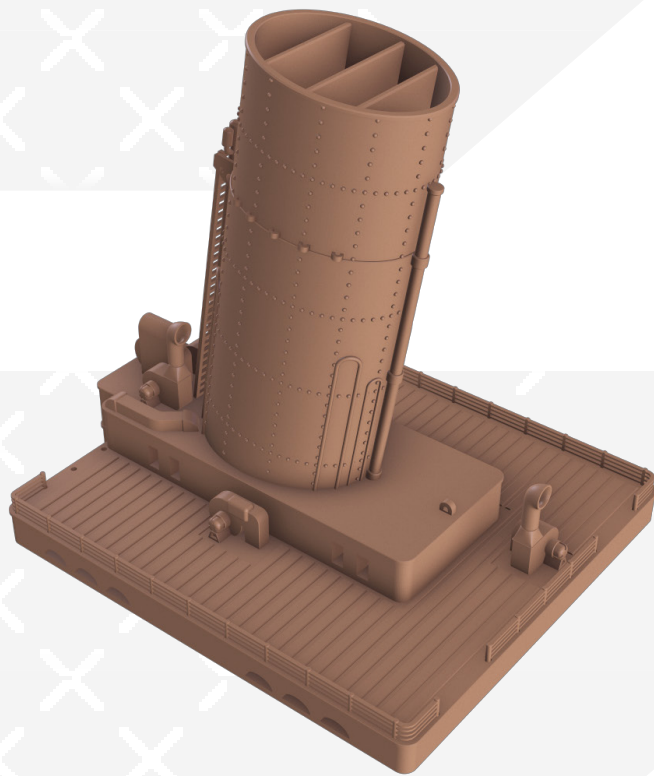
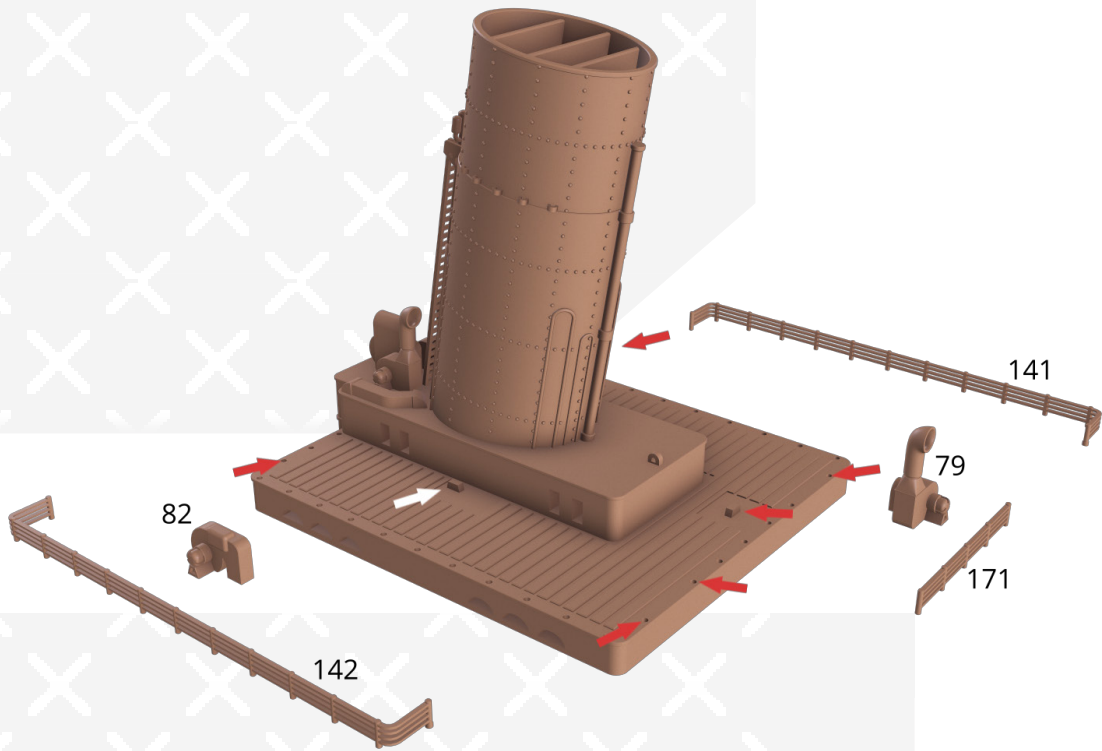

59

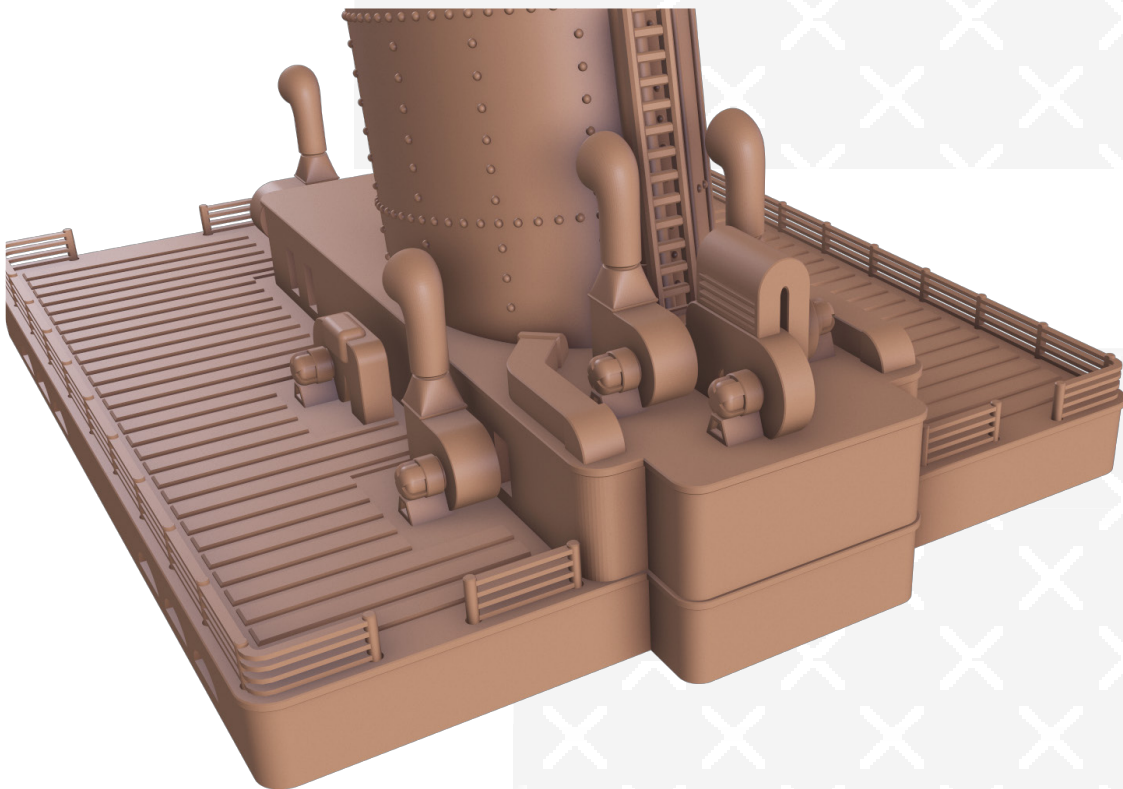
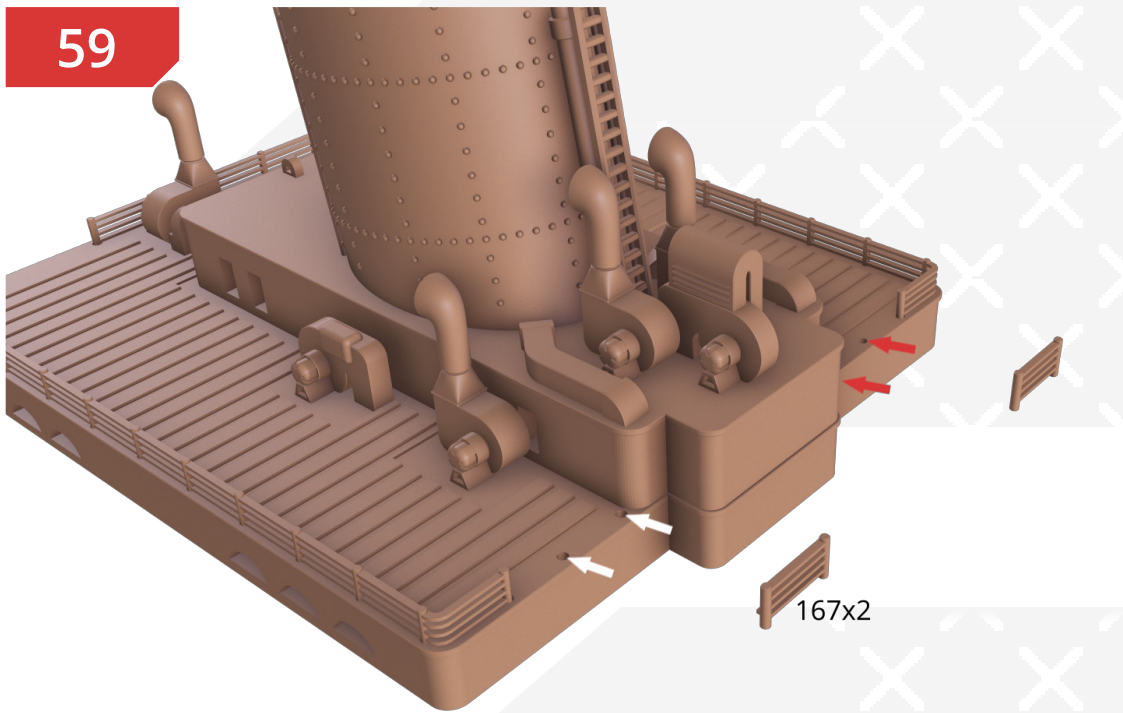

60

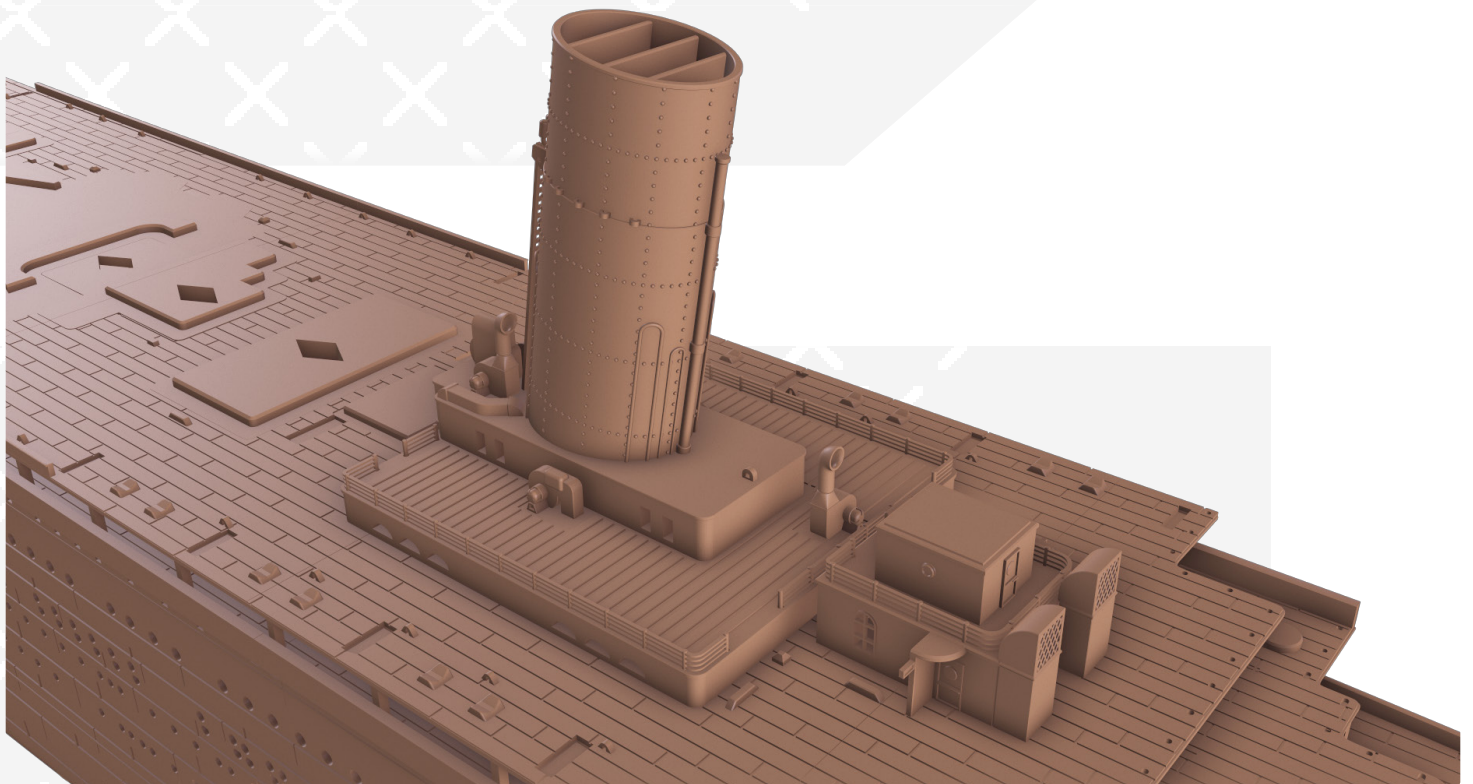
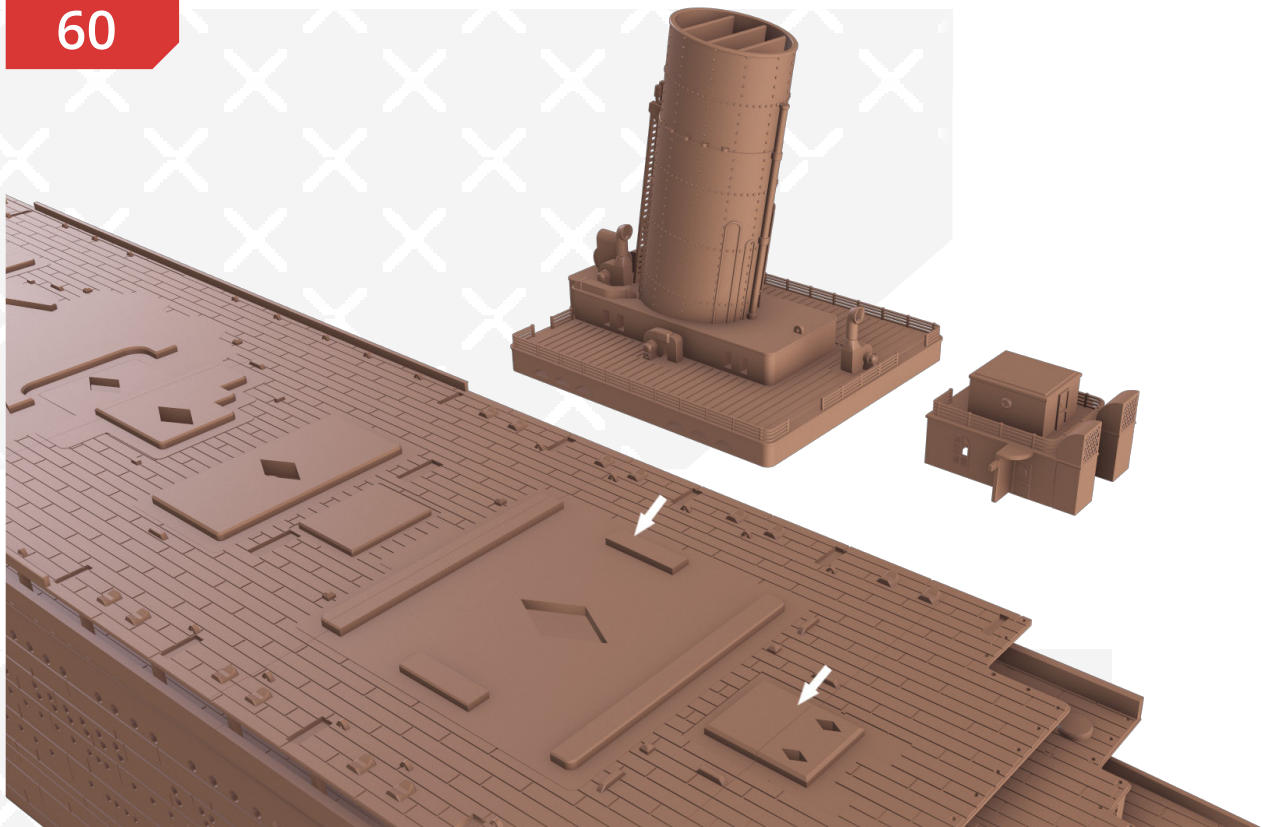

61

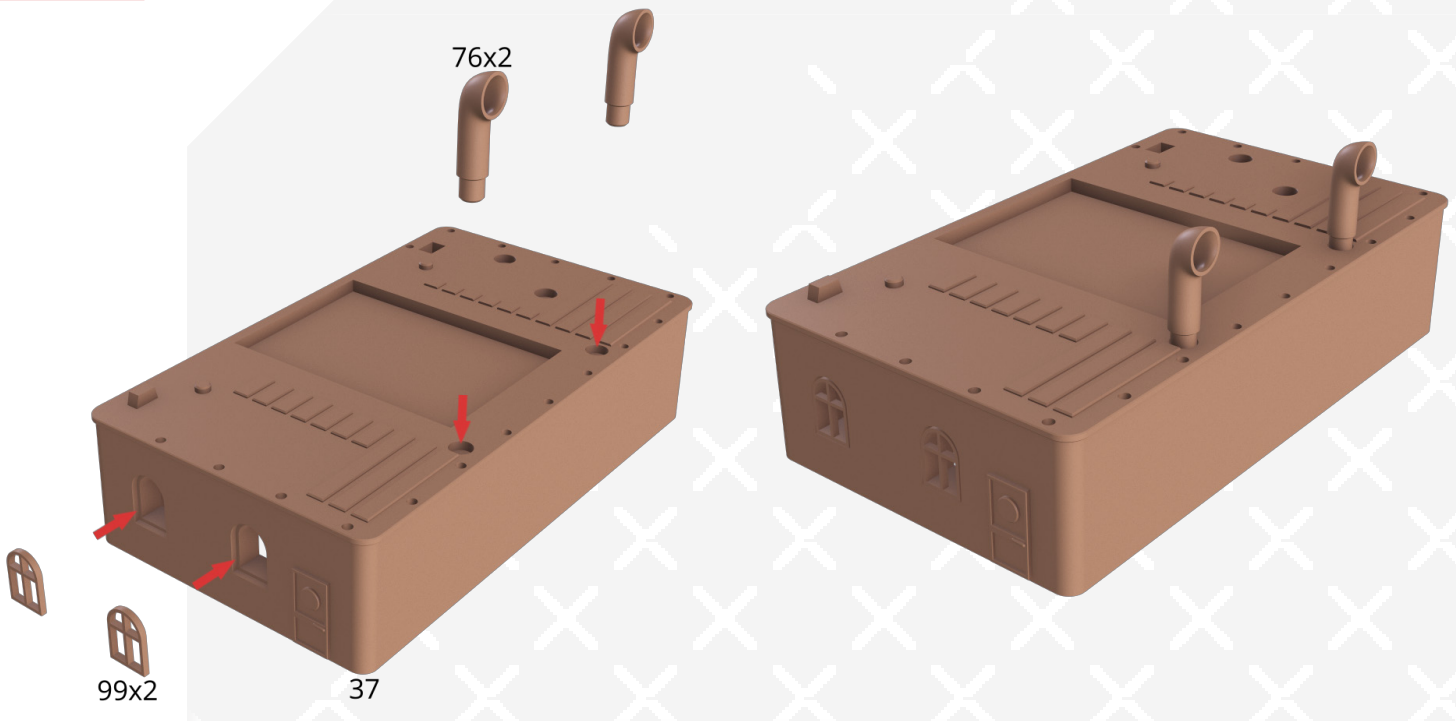

62

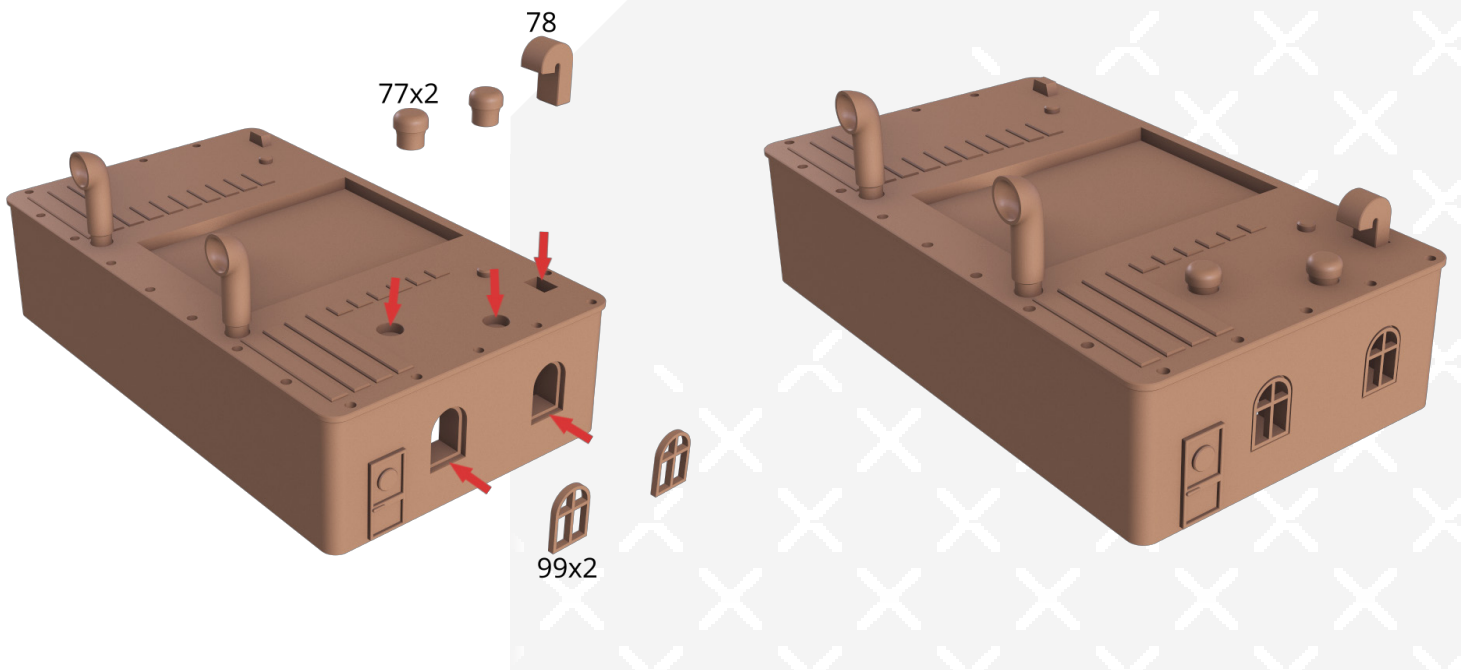

63

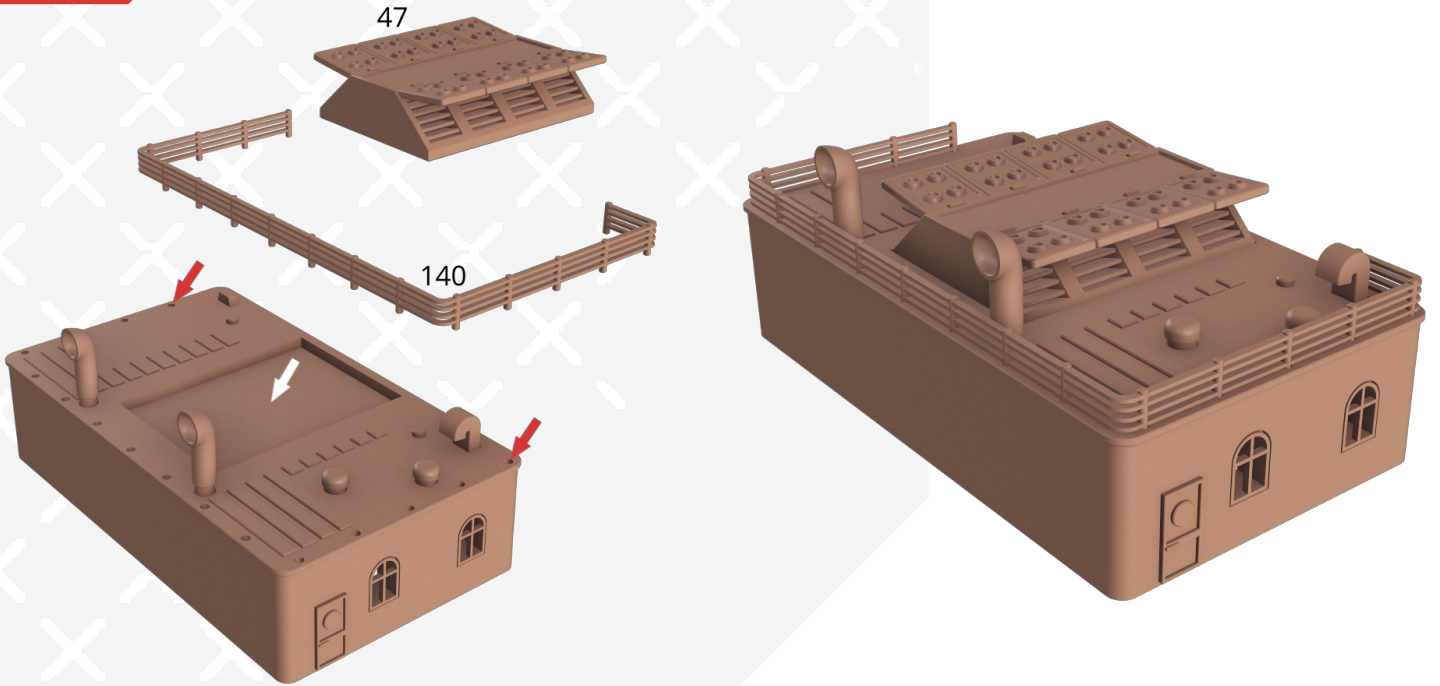

64

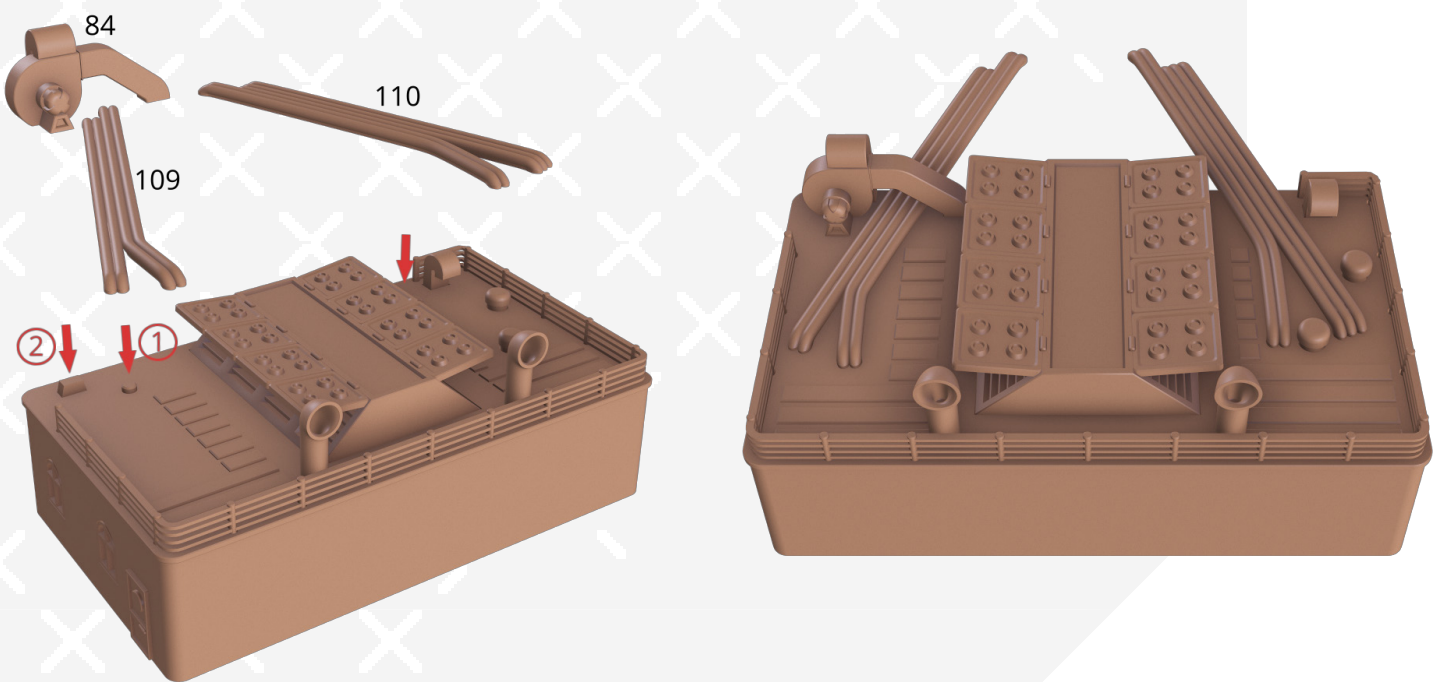

65

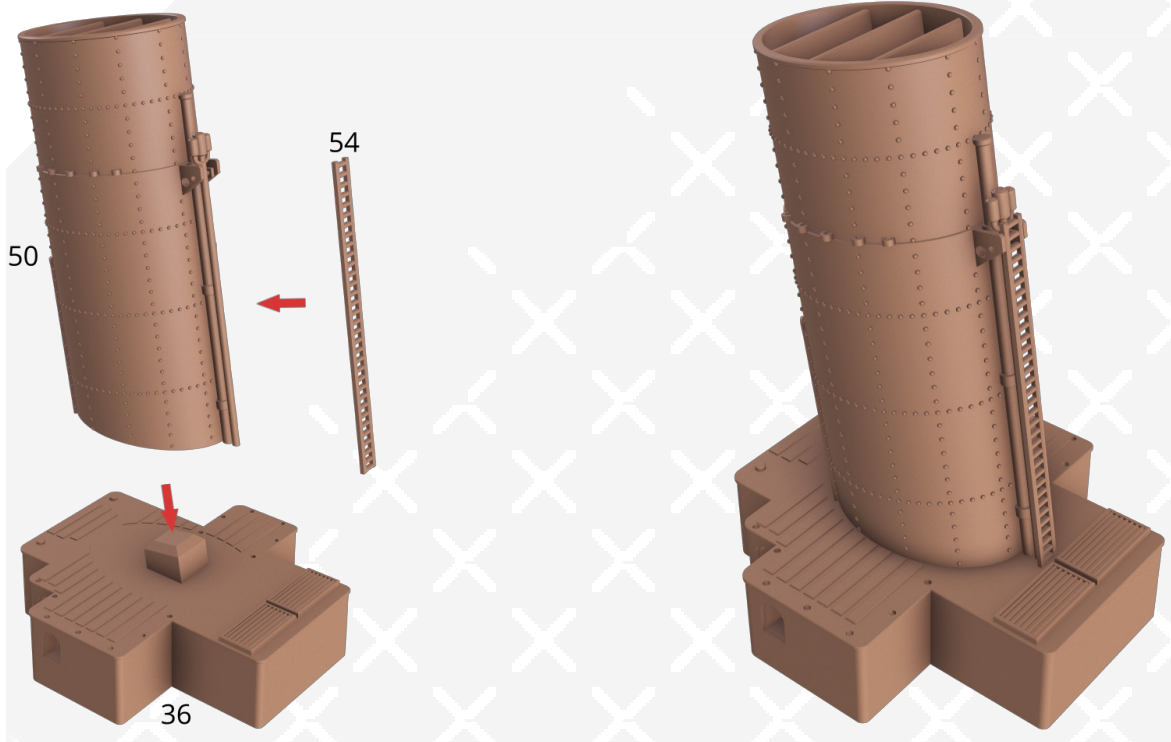

66

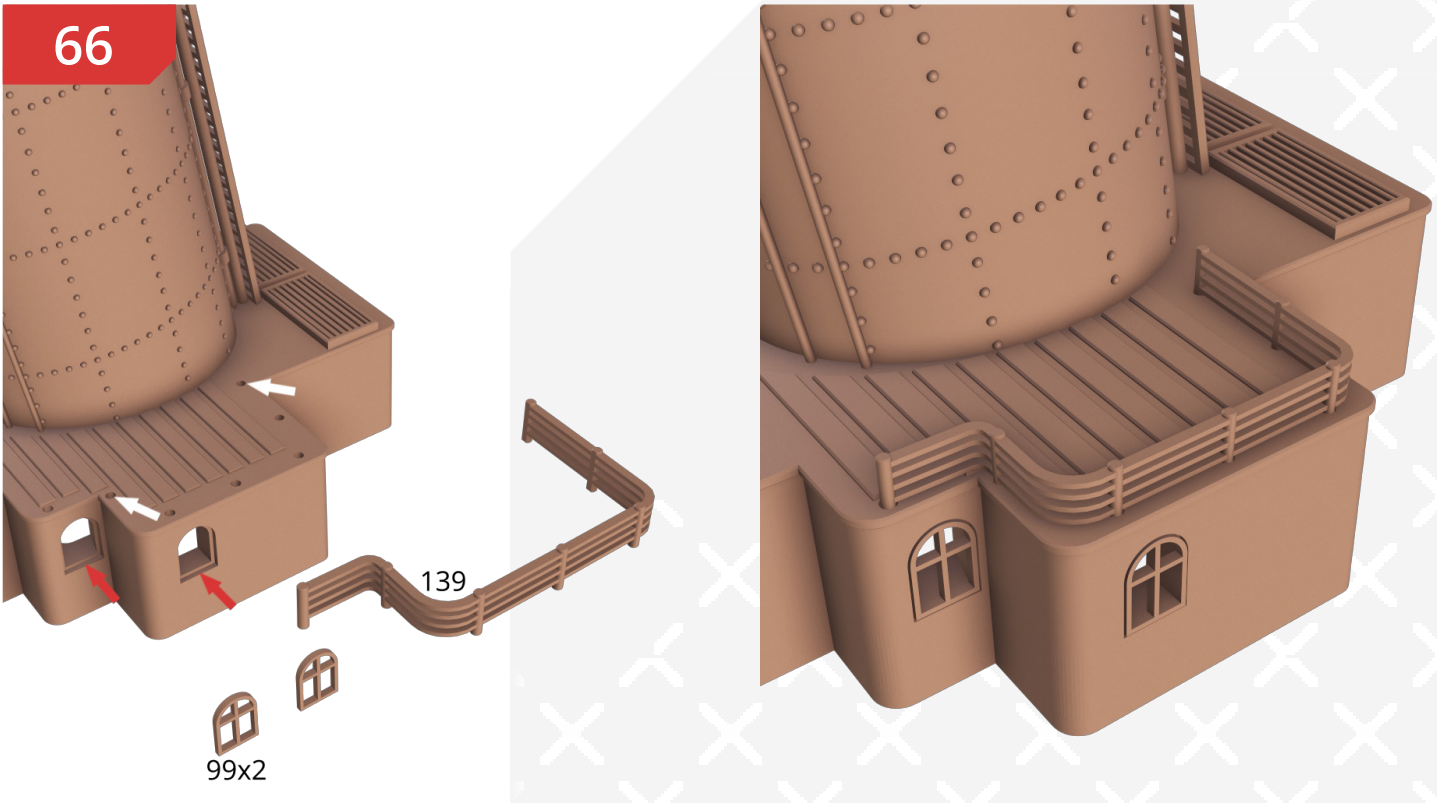

67

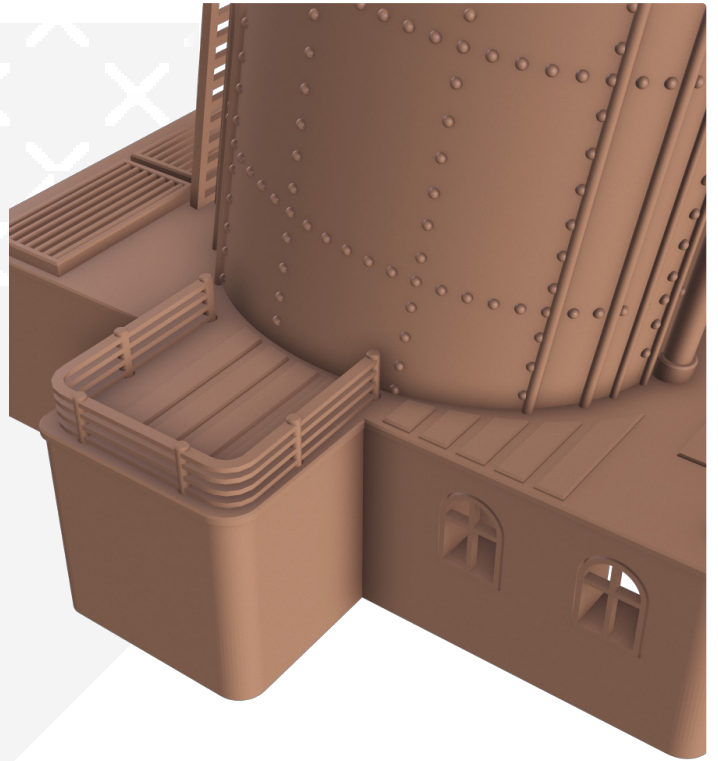
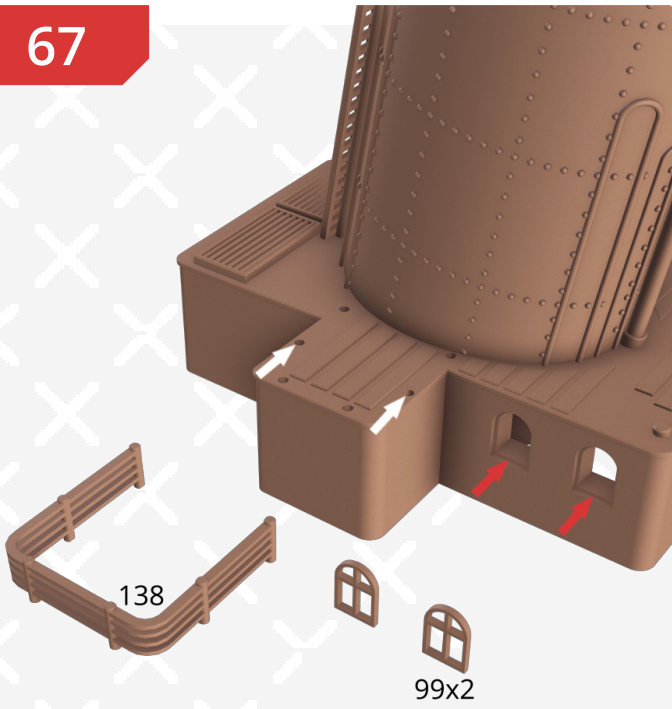

68

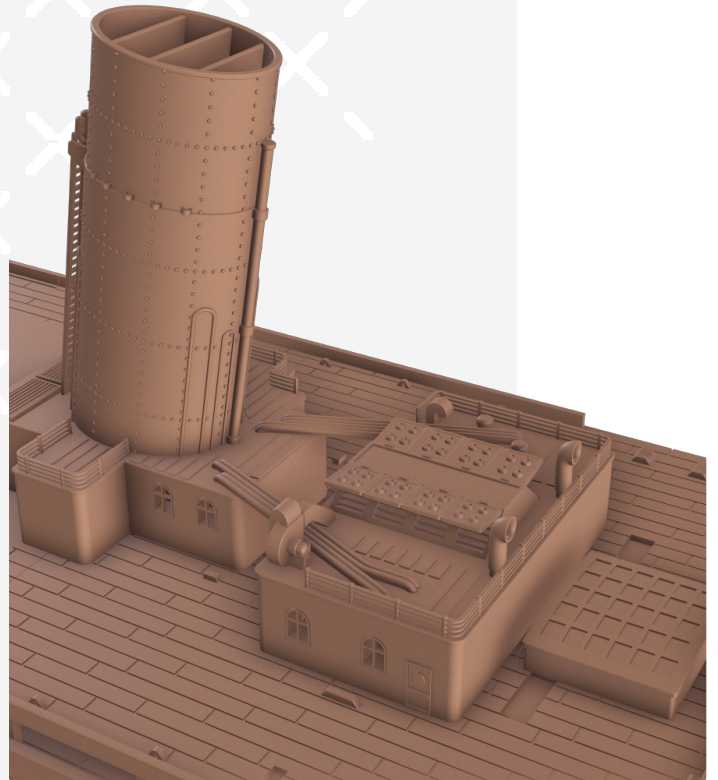
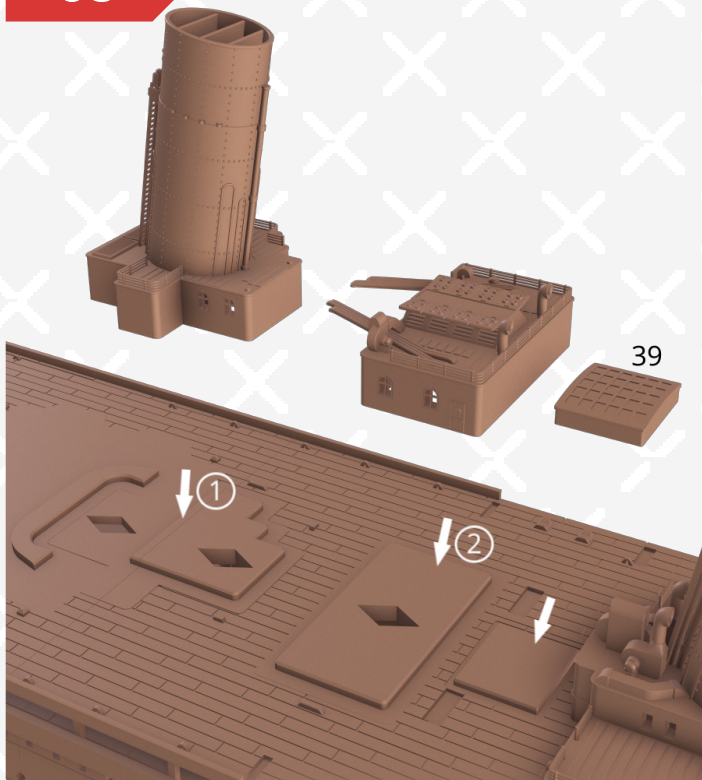

69

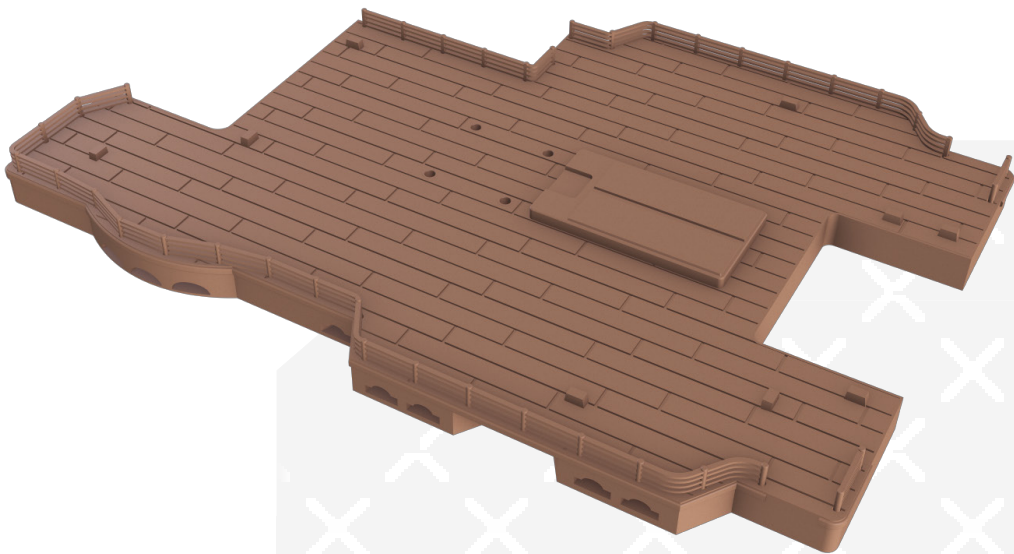
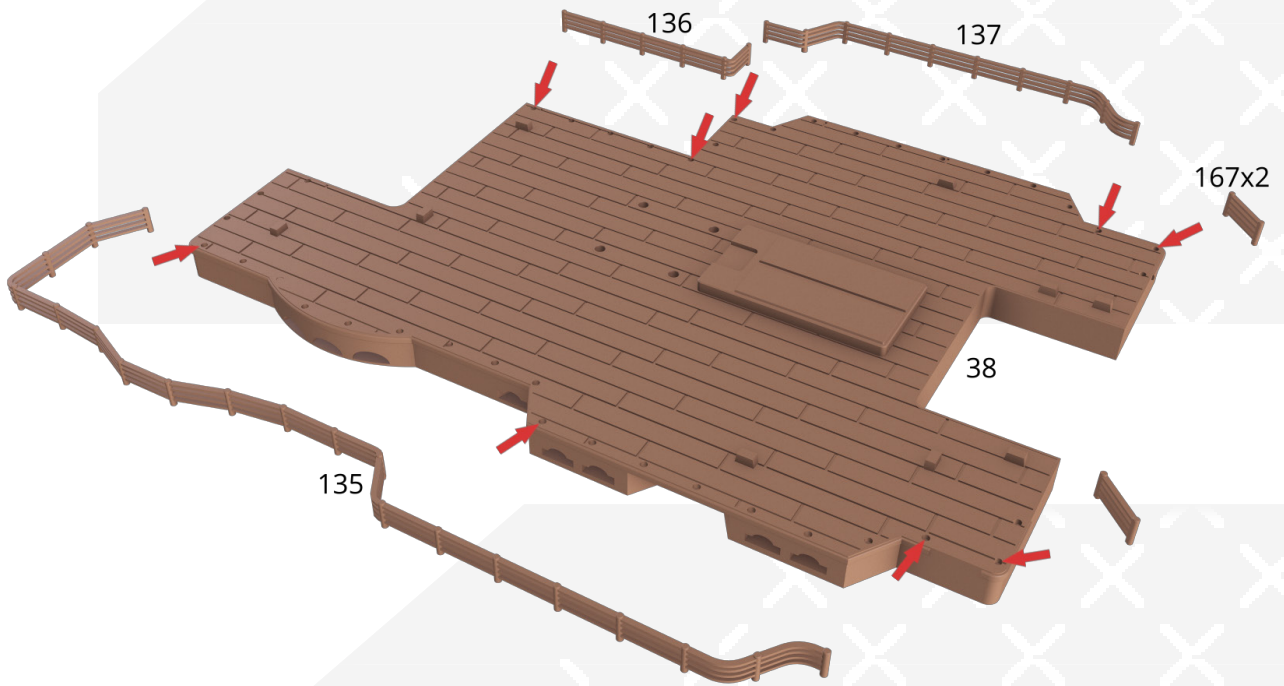

70

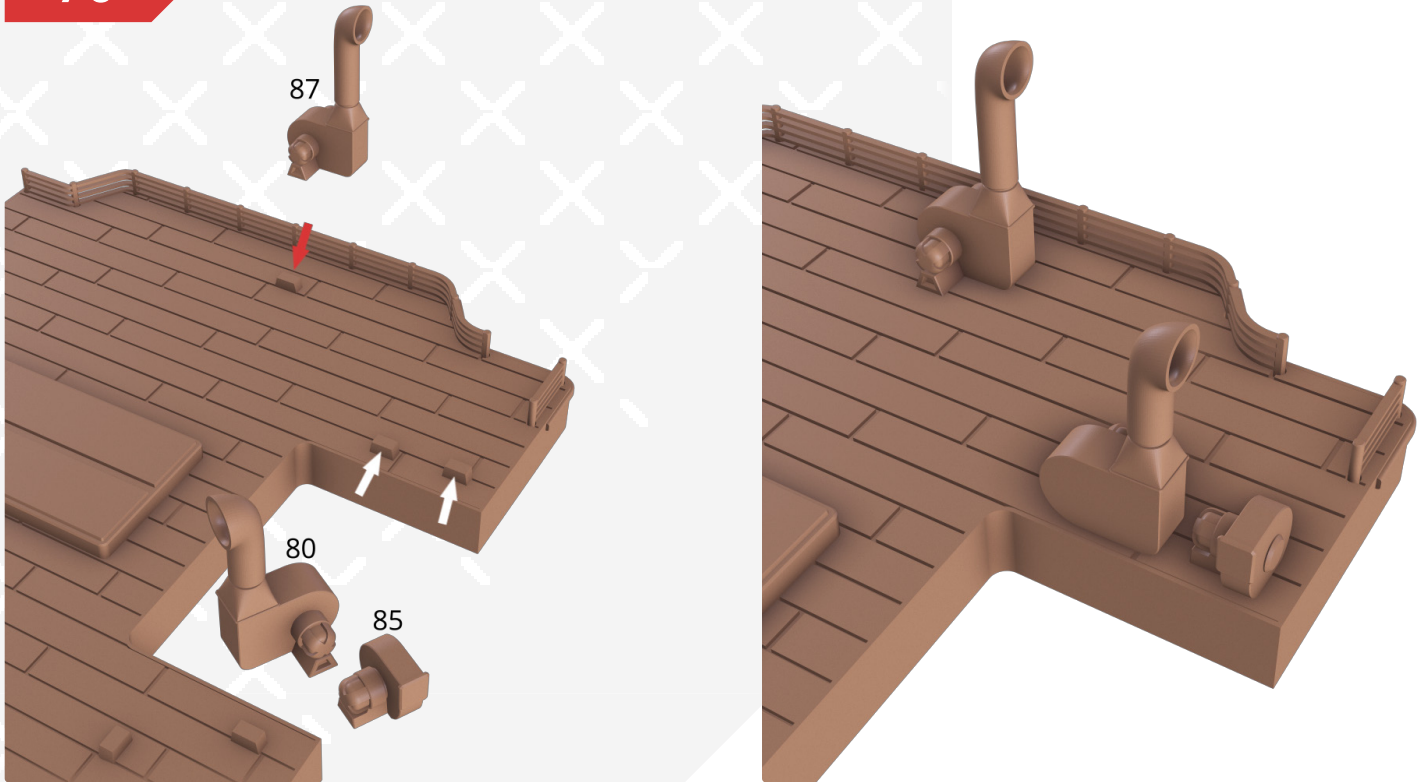

71

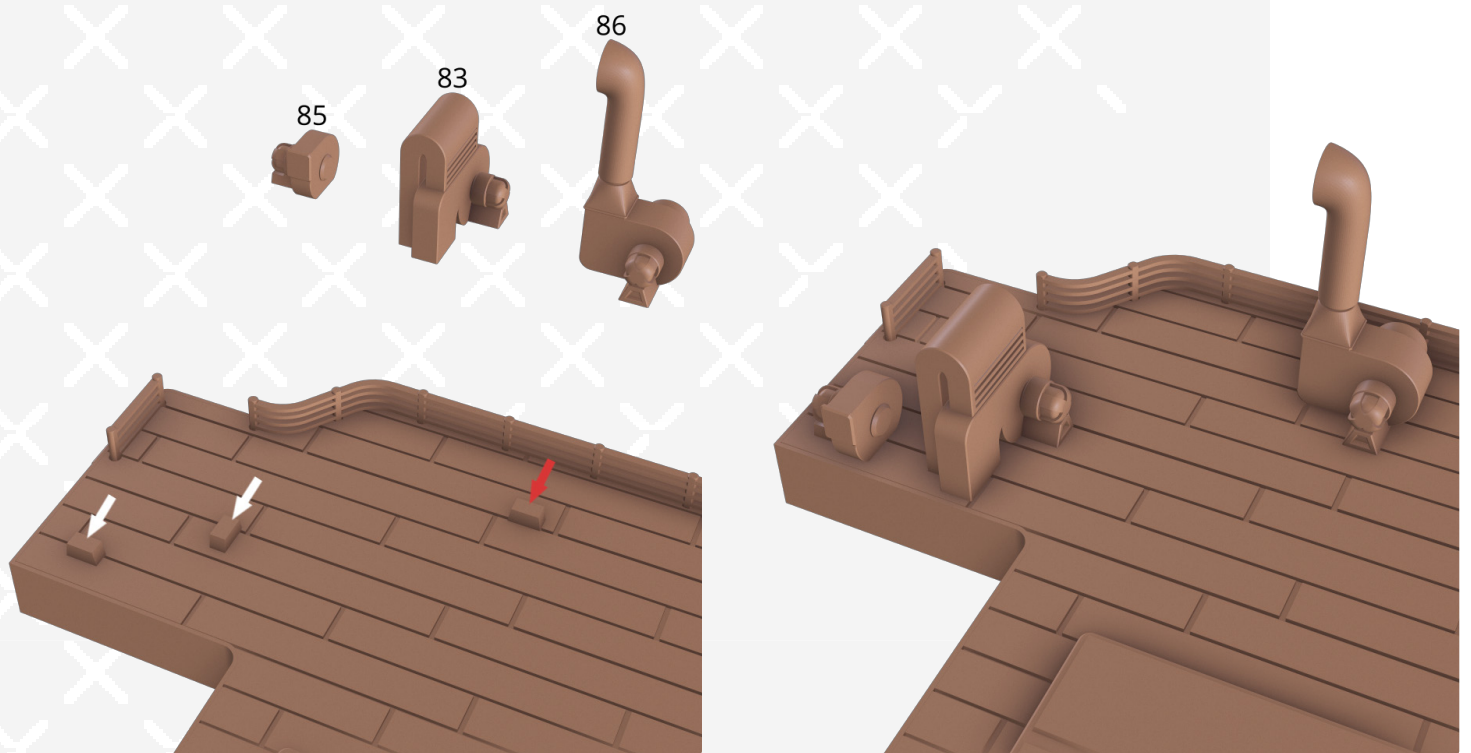

72

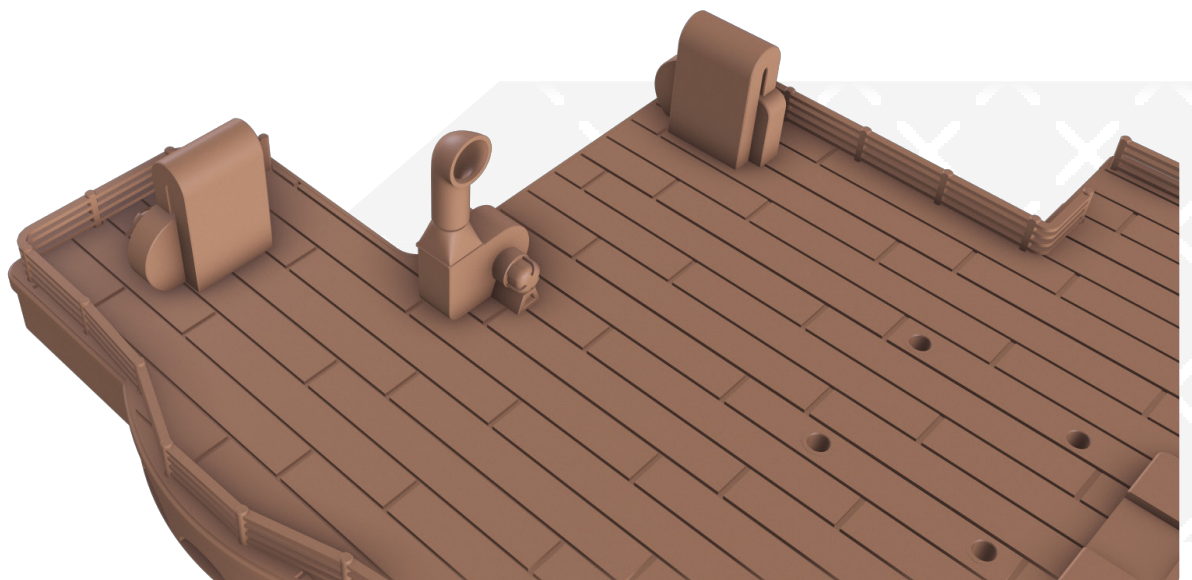
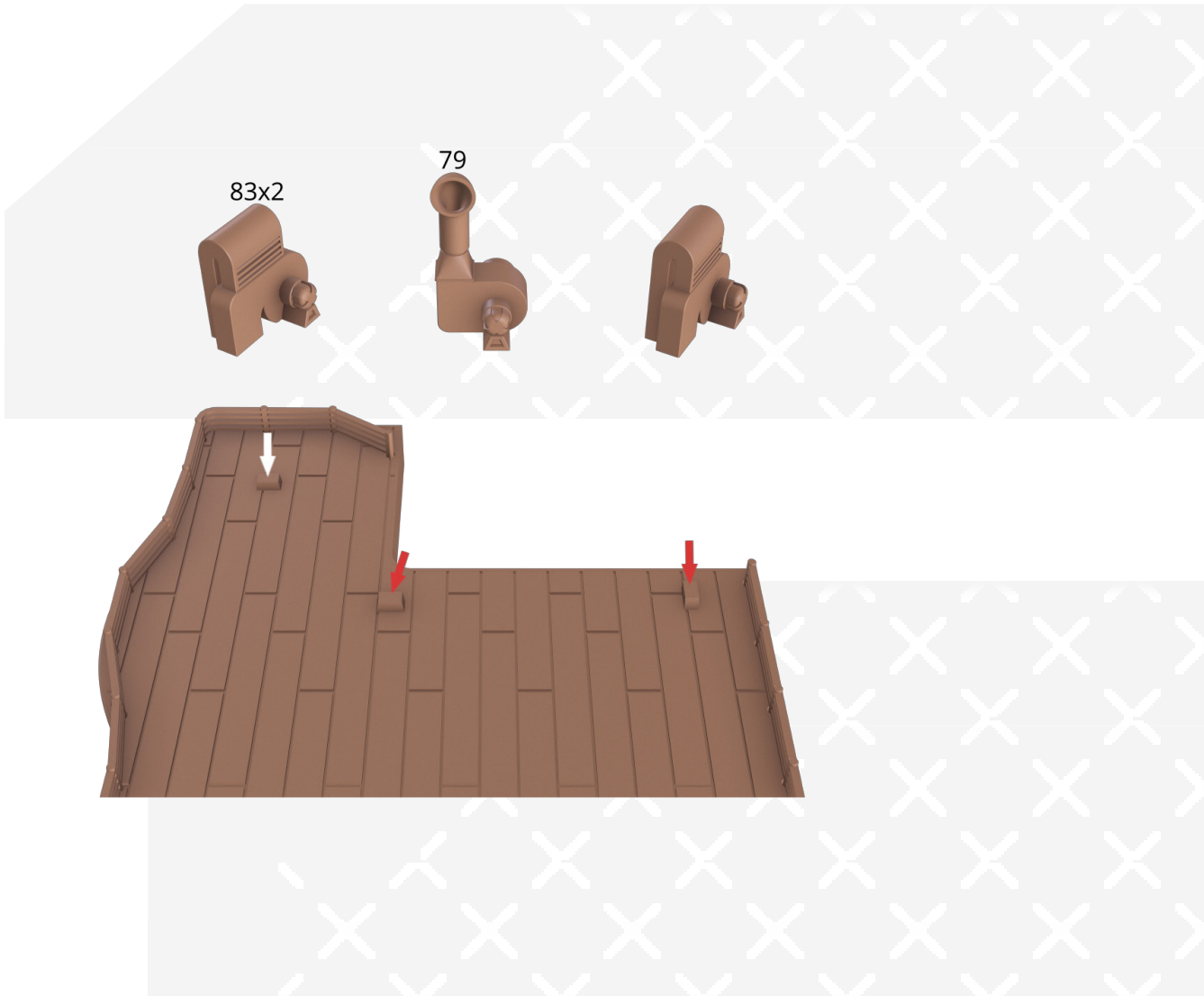

73

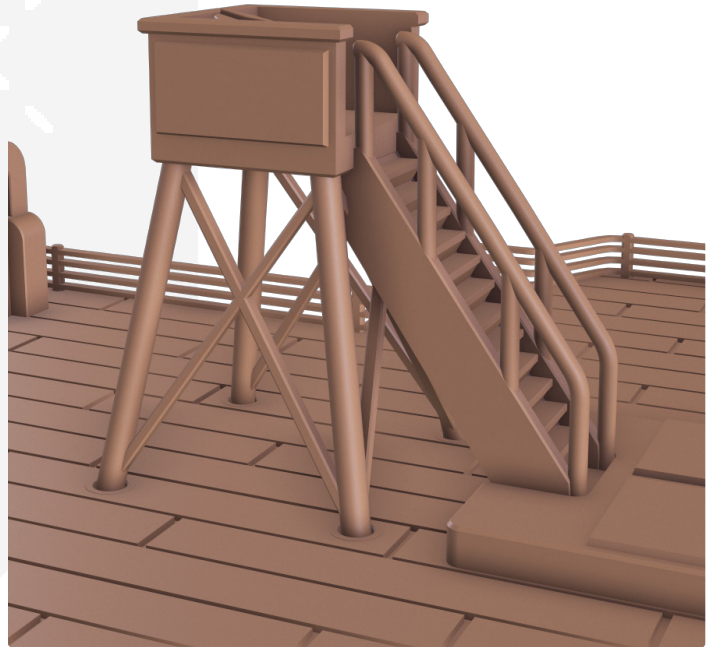

74

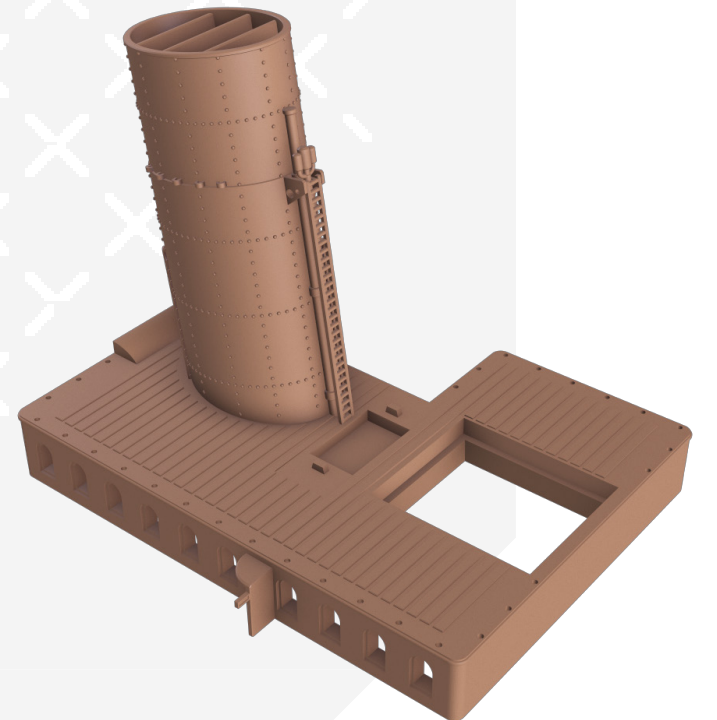
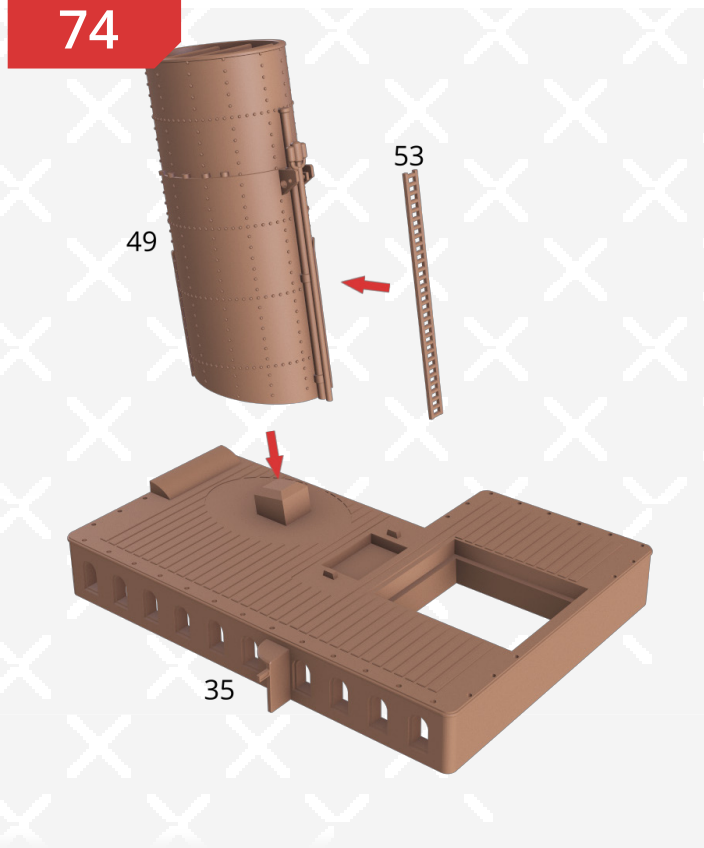

75

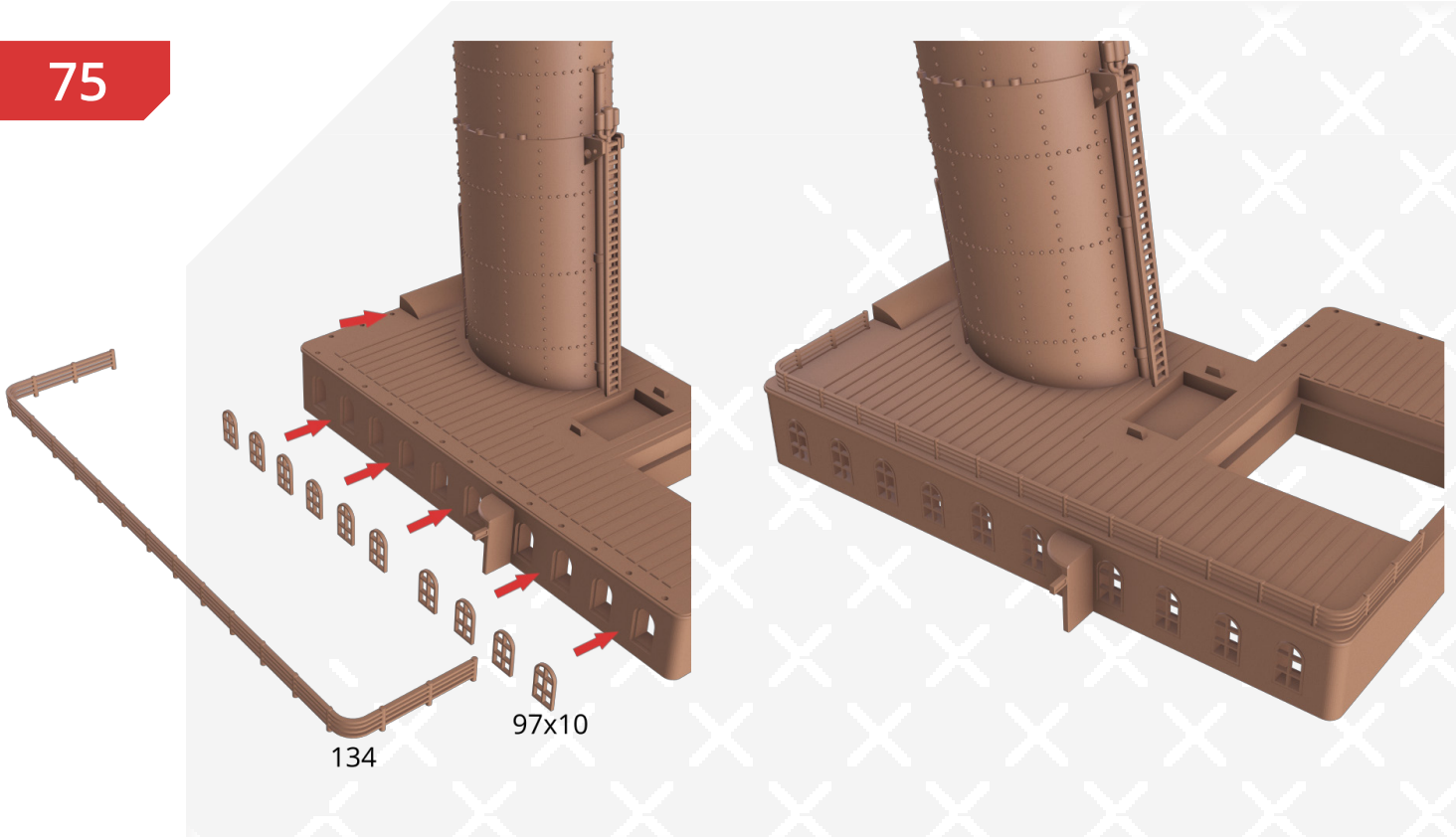

76

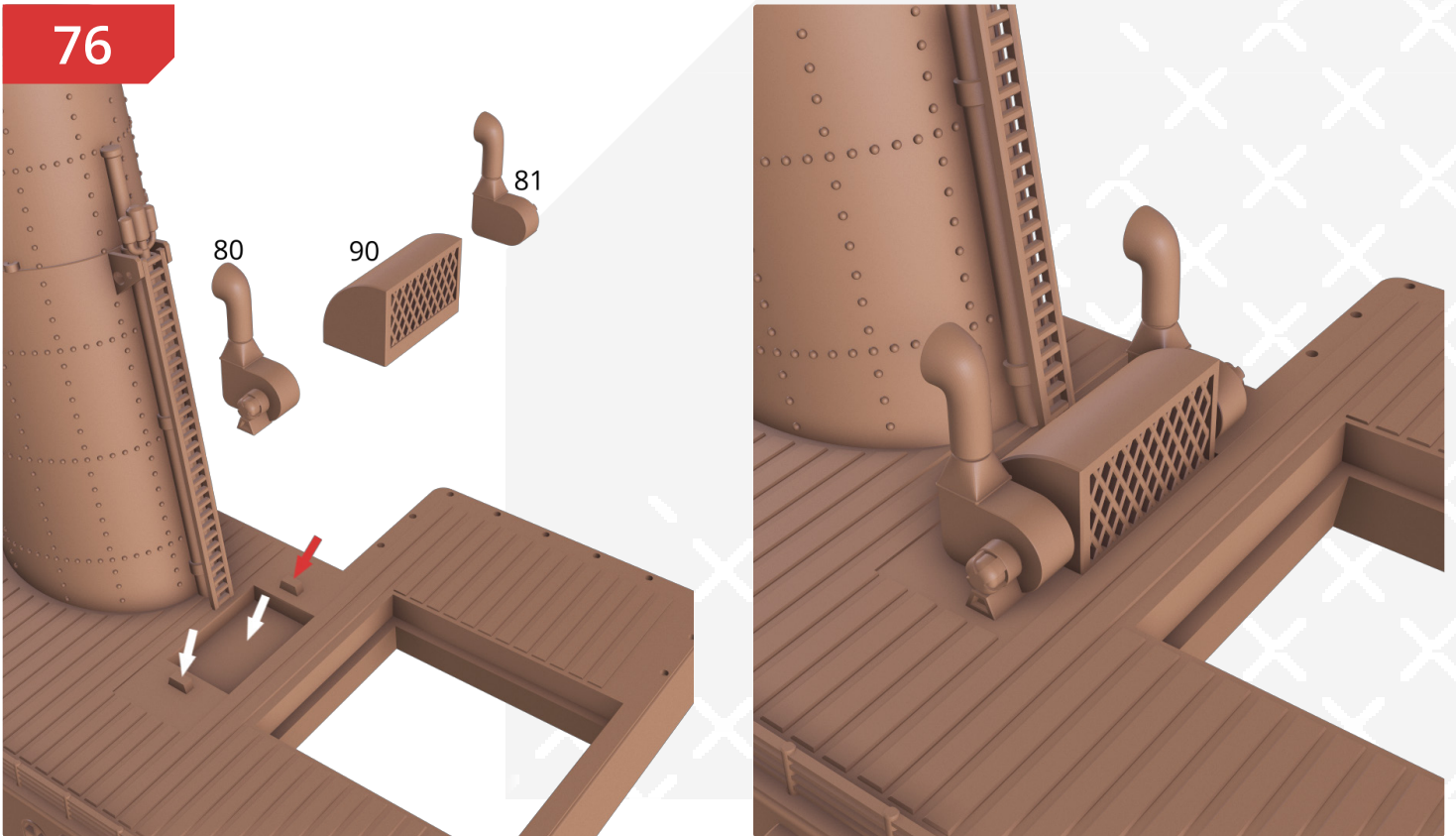

77

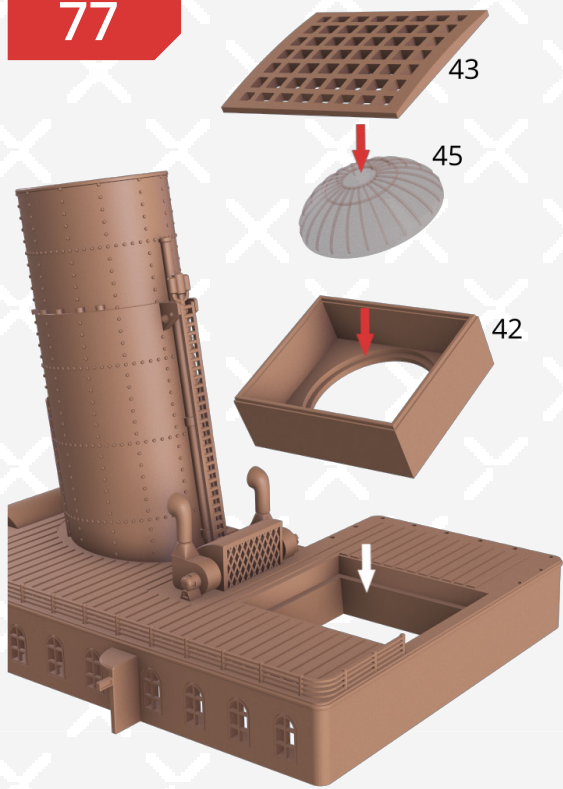

78

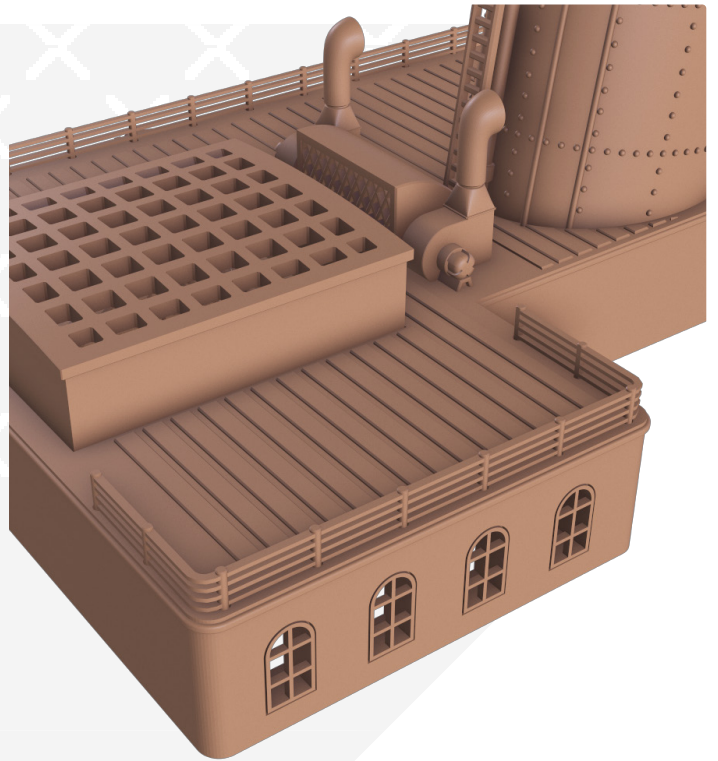
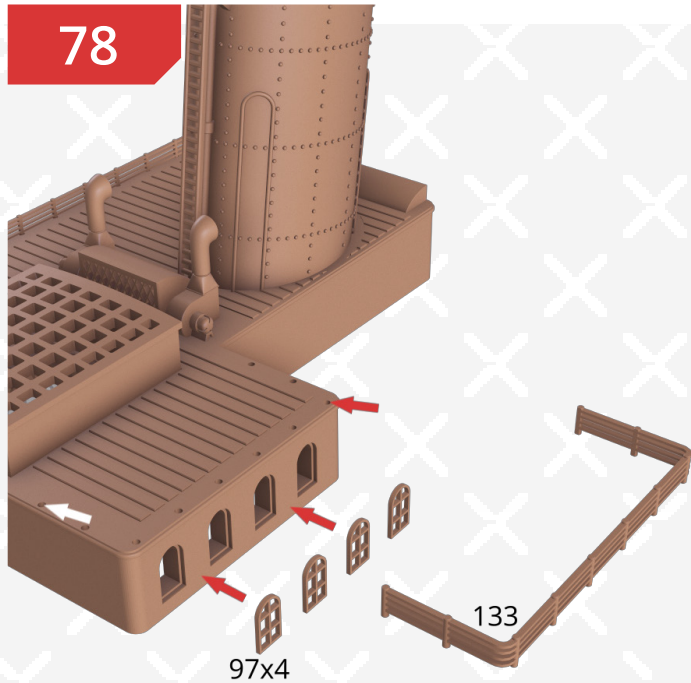

79

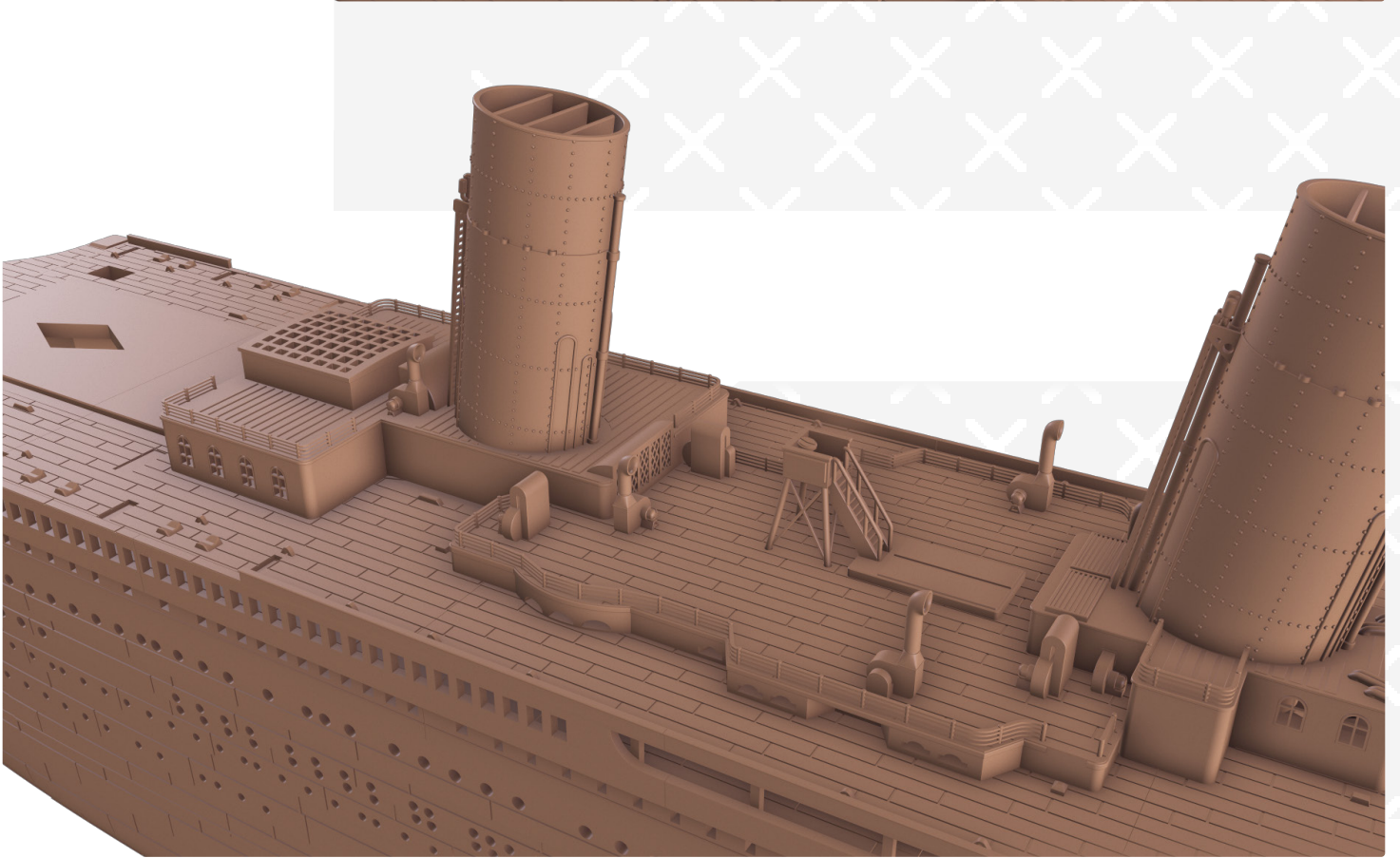
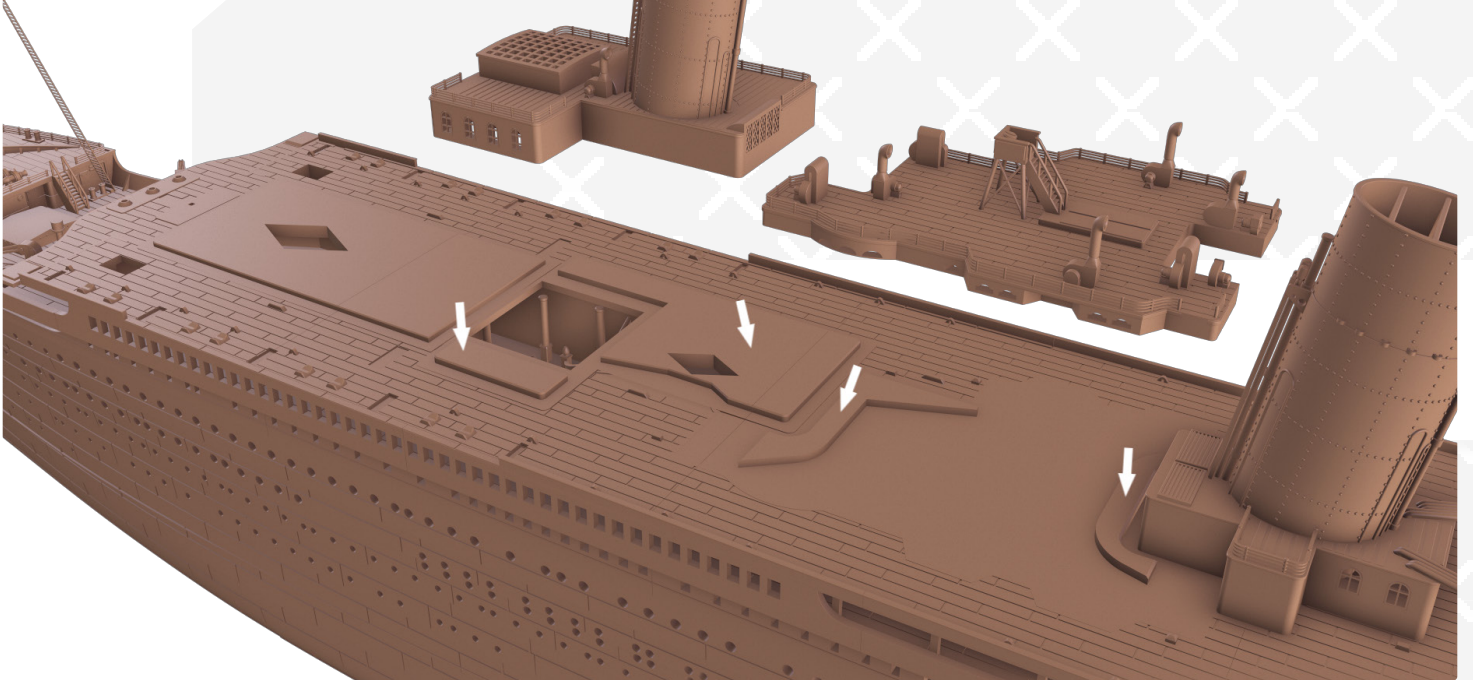

80

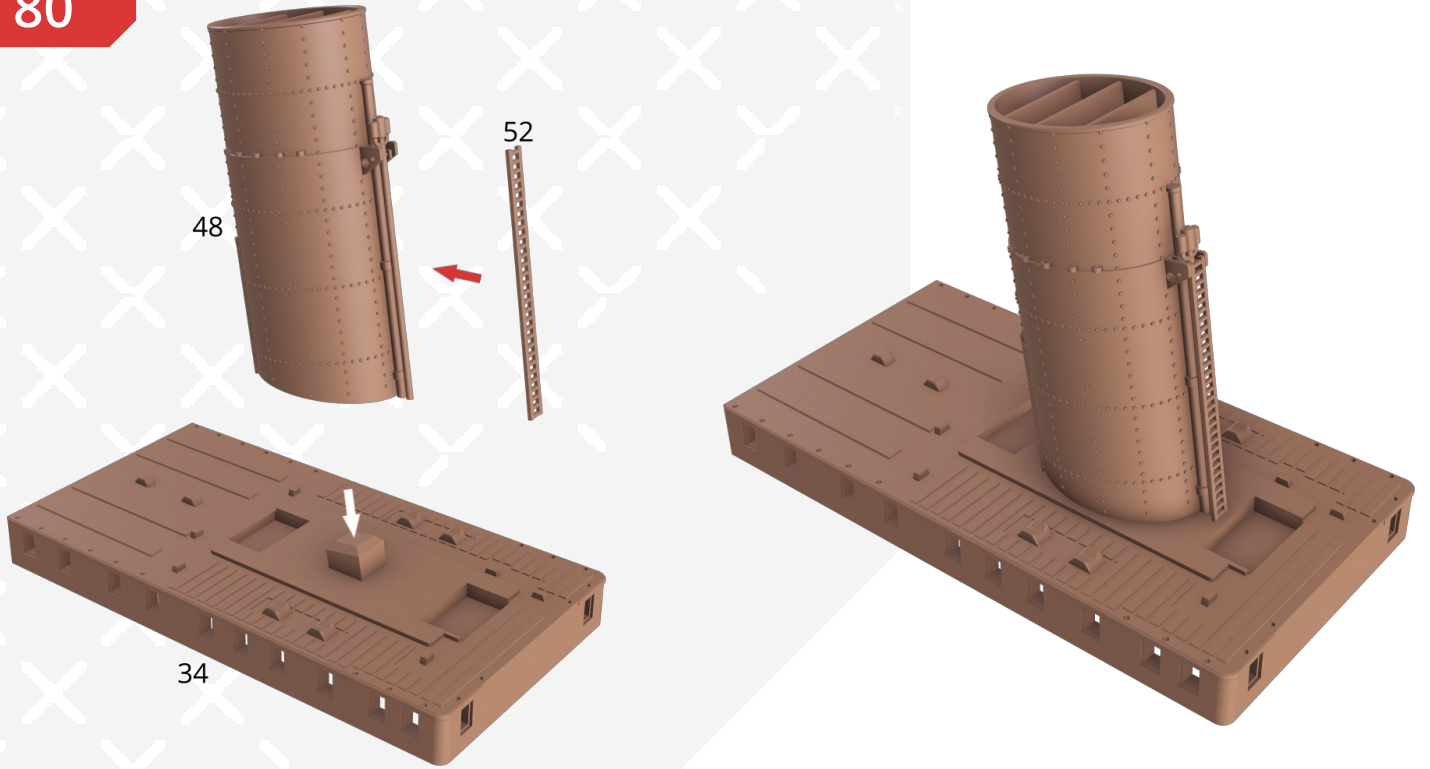

81

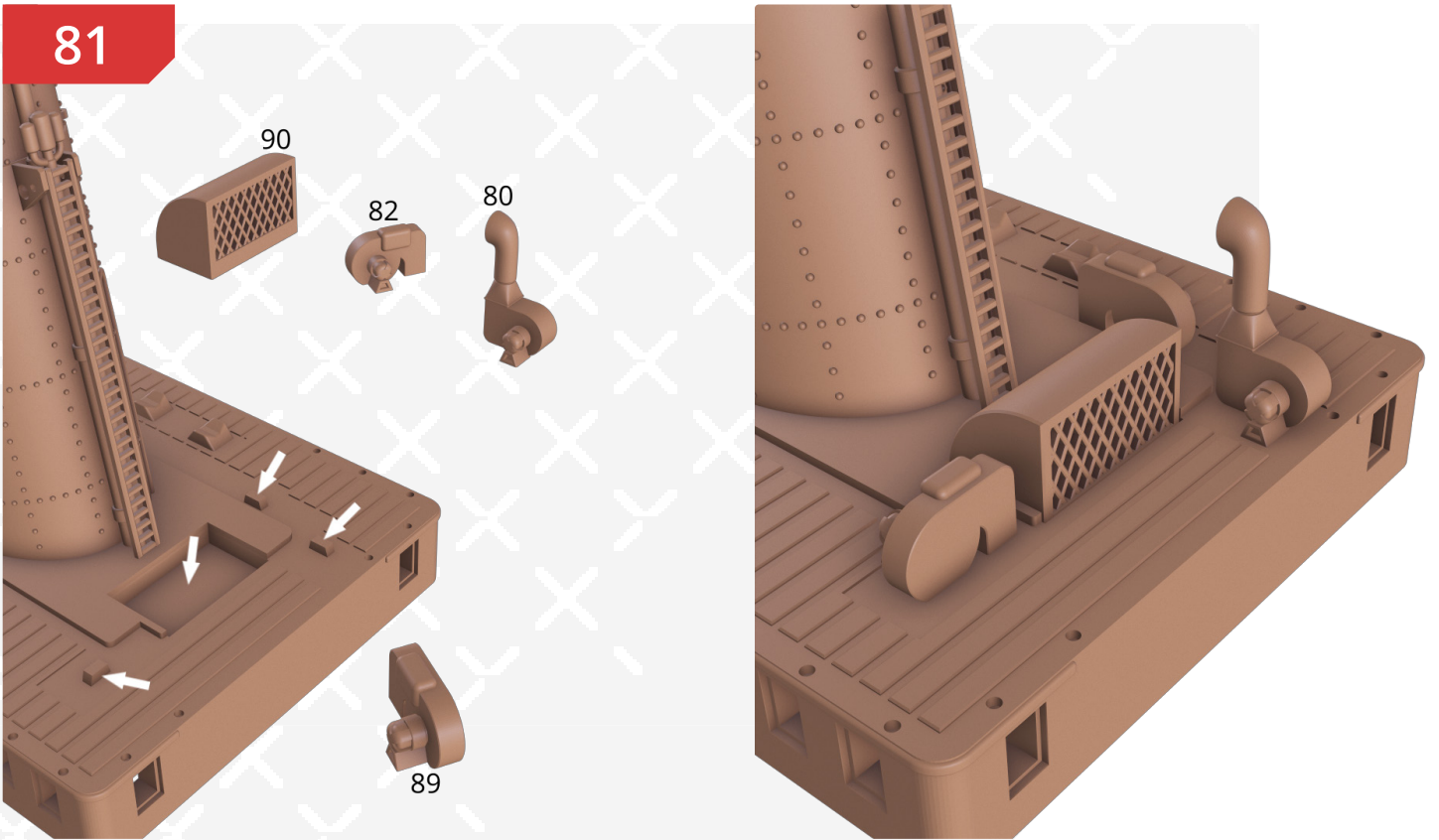

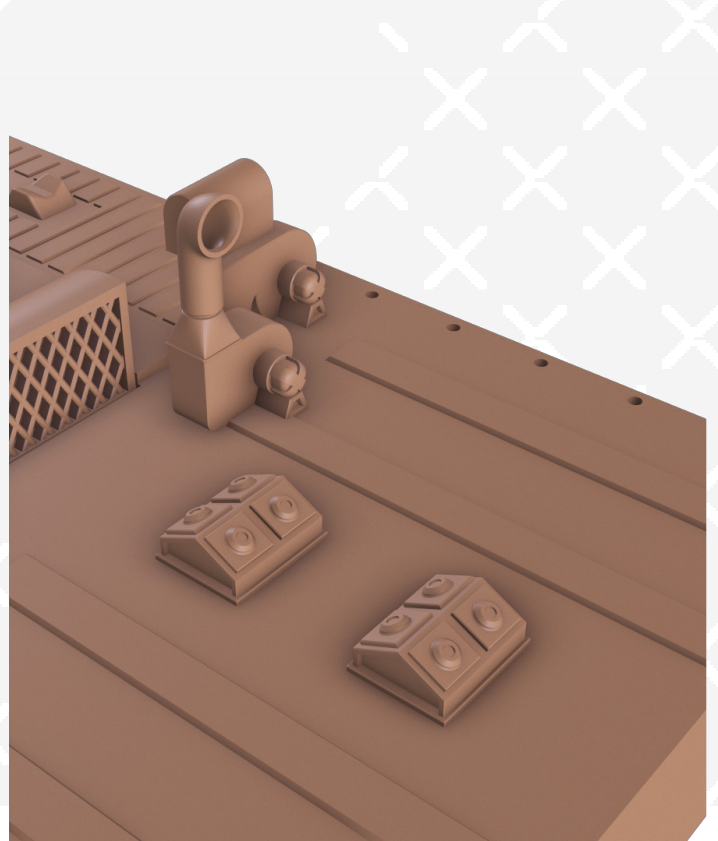
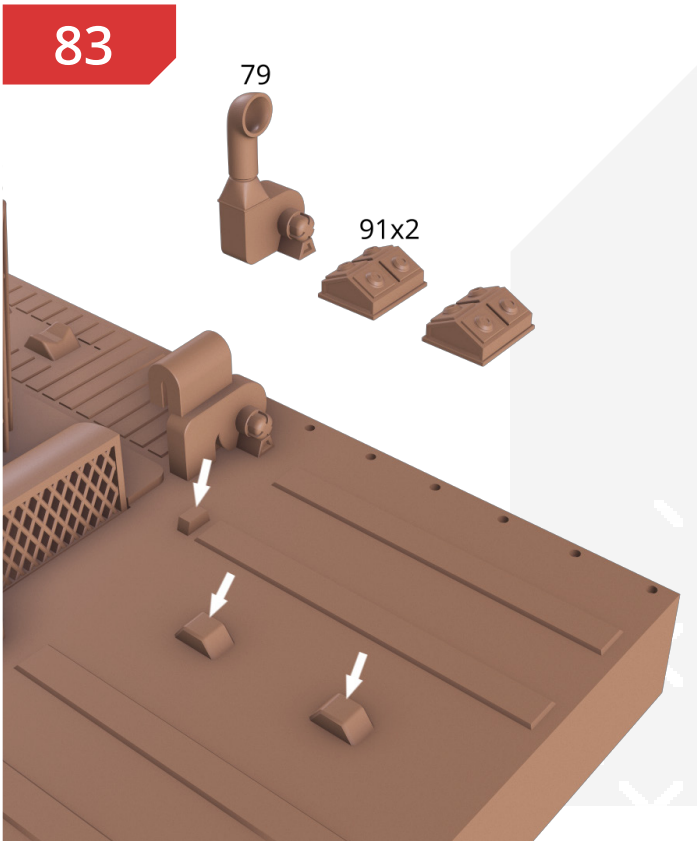
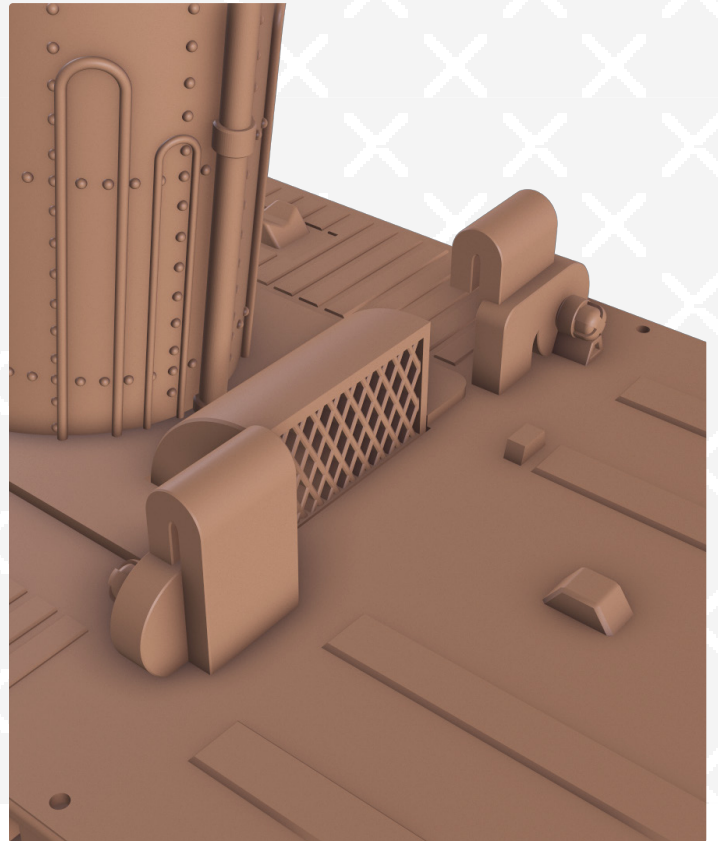
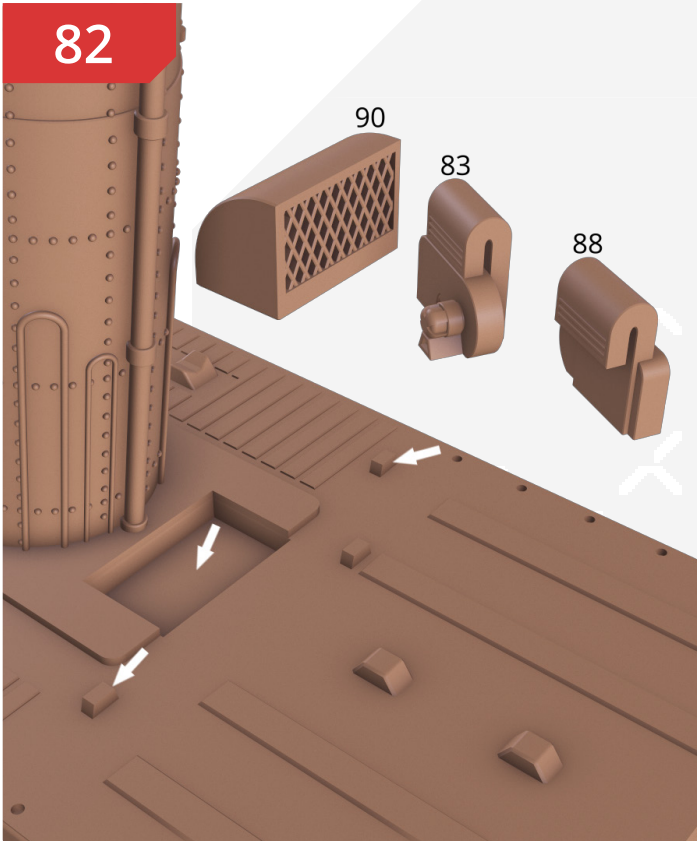

84

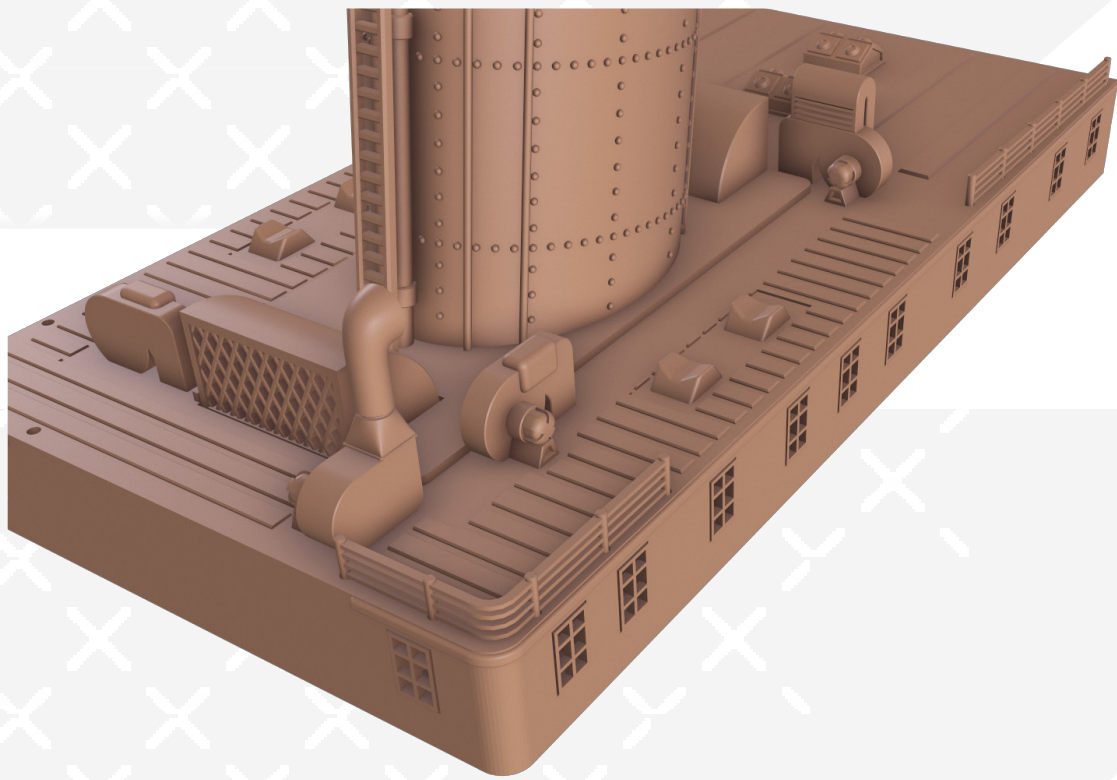
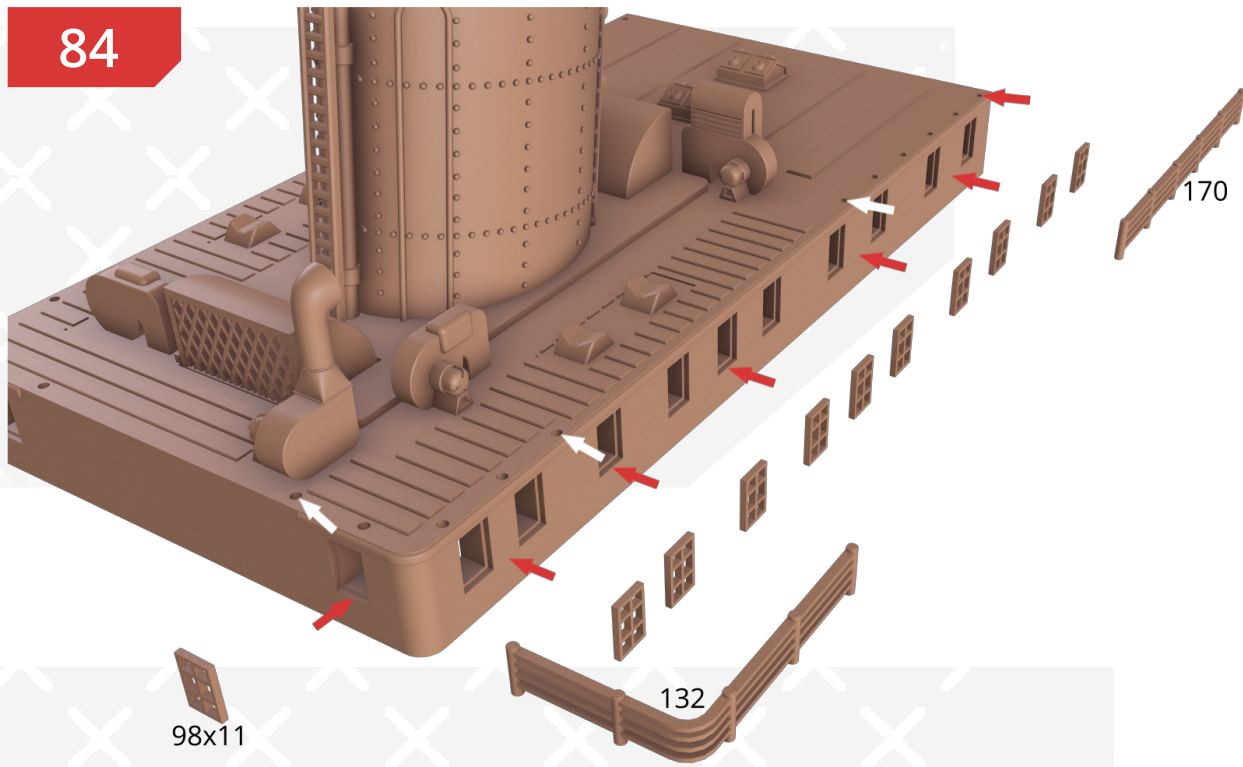

85

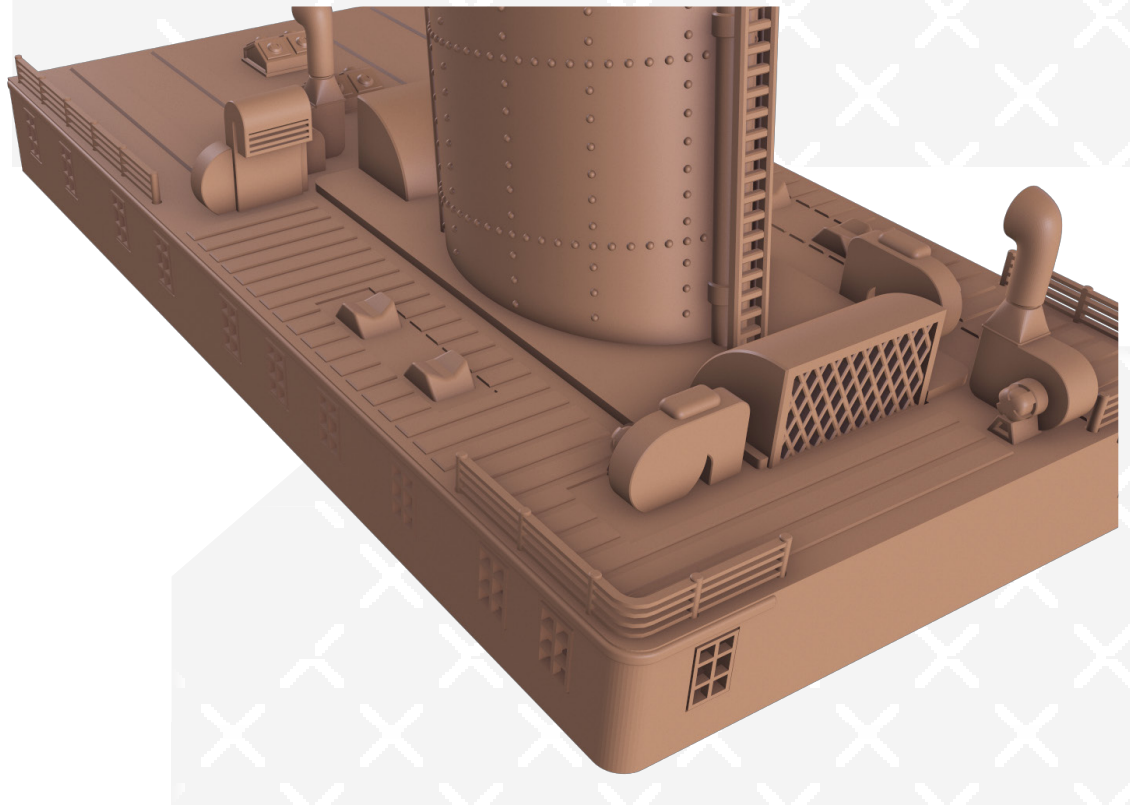
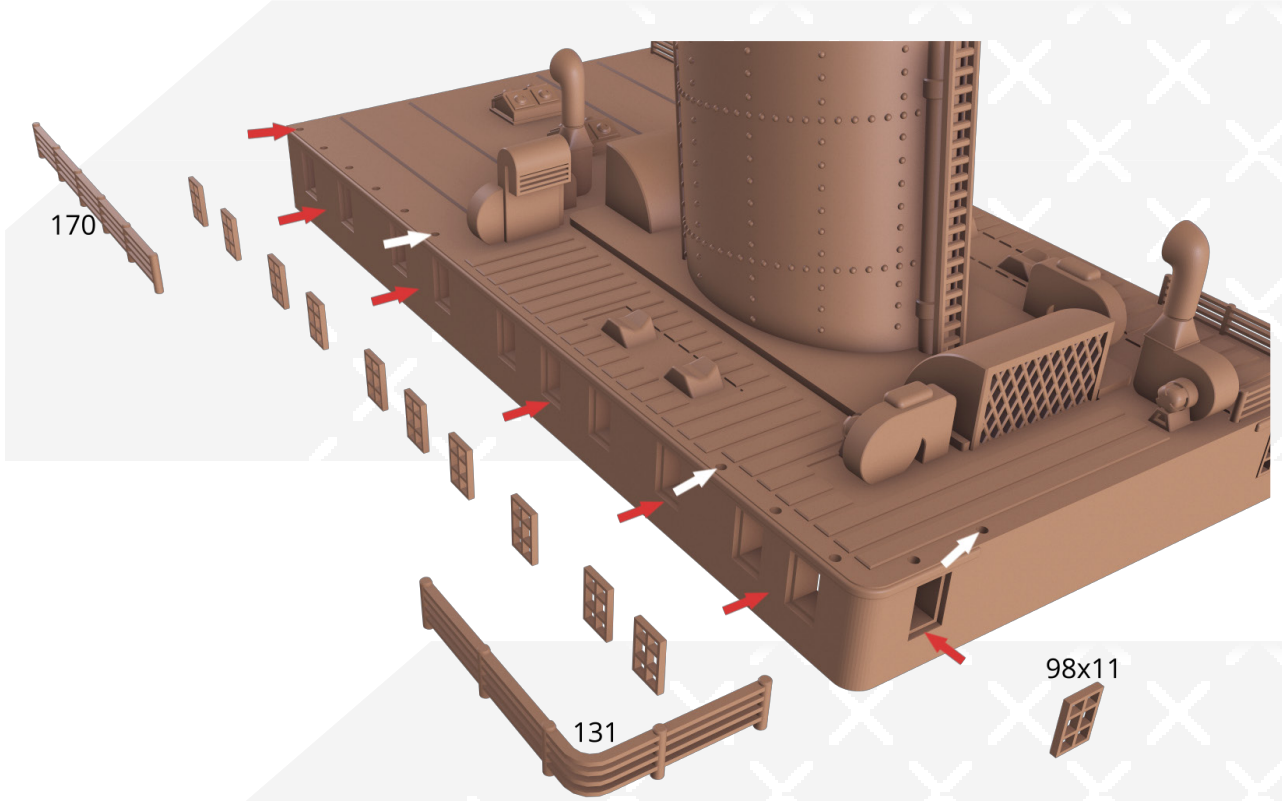

86

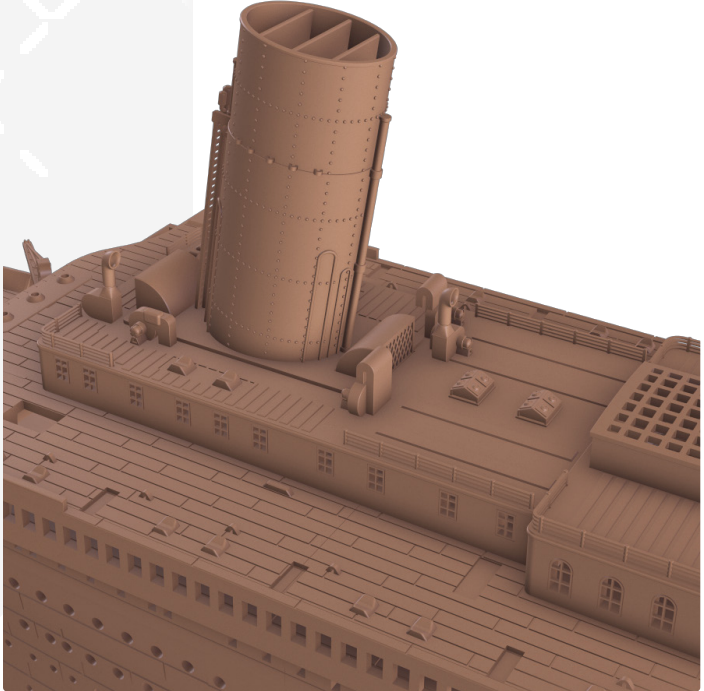
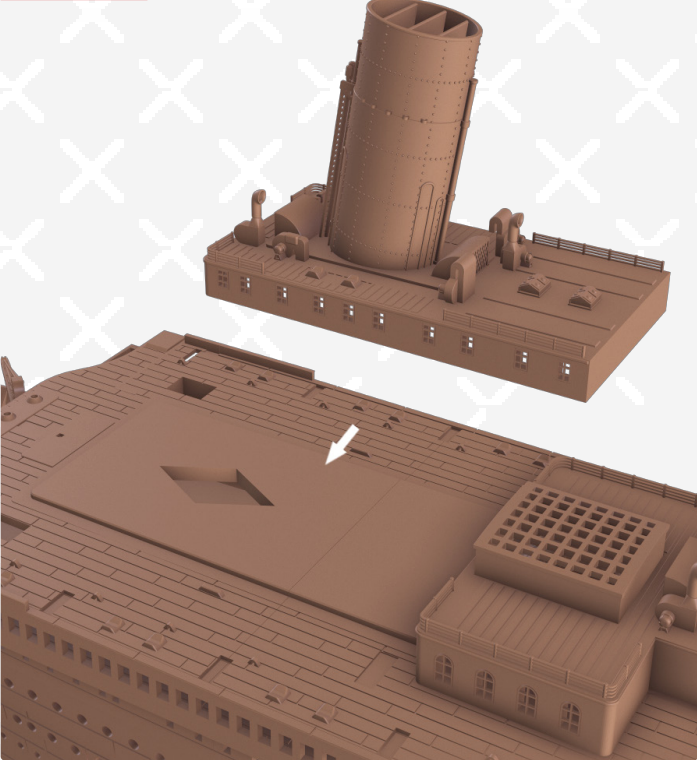

87

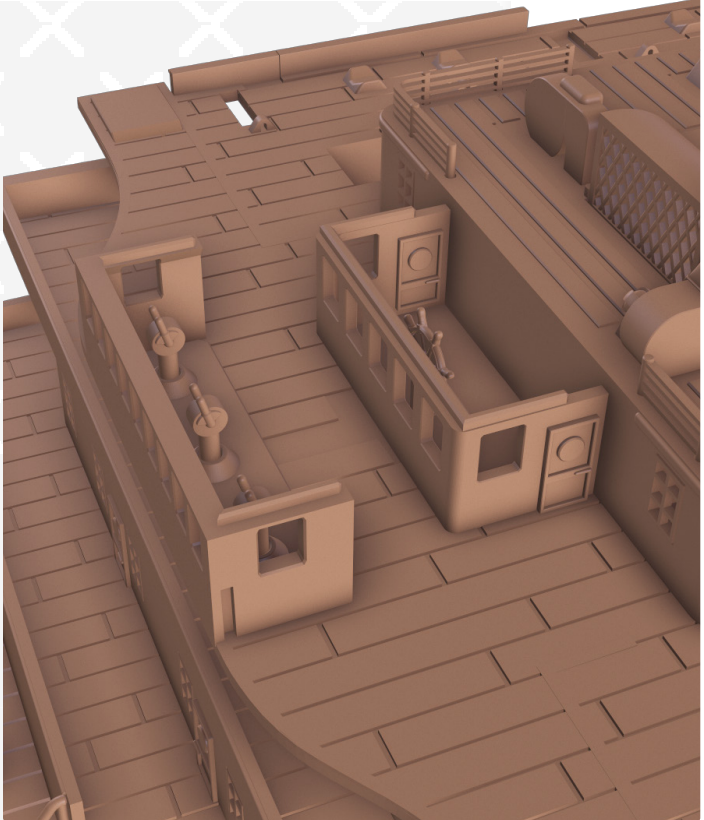
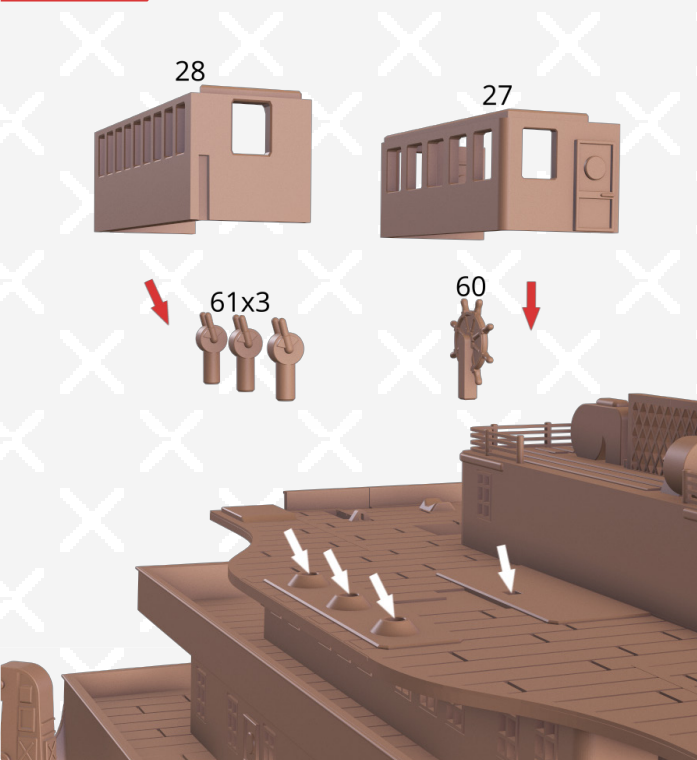

88

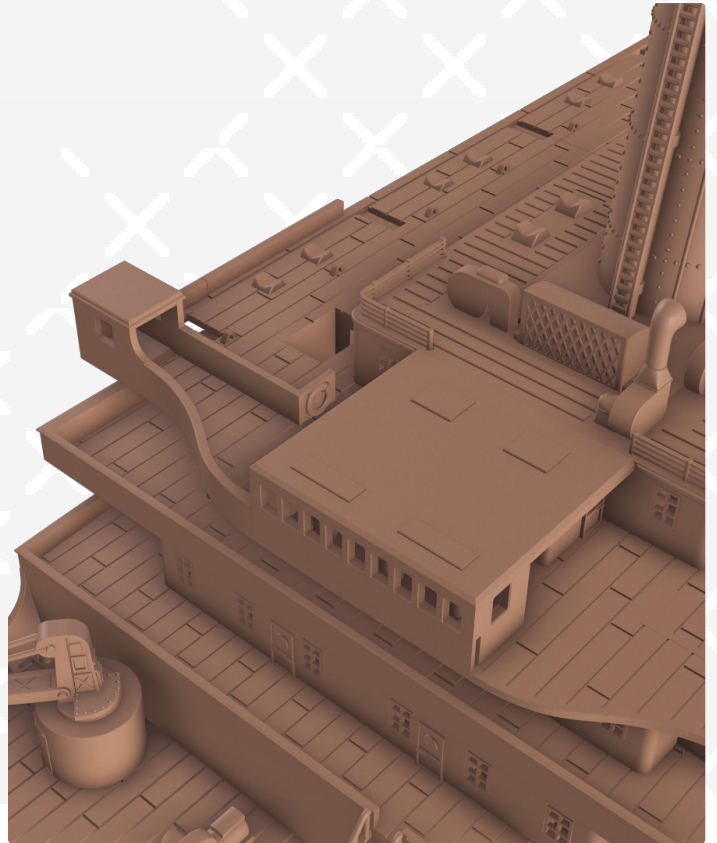
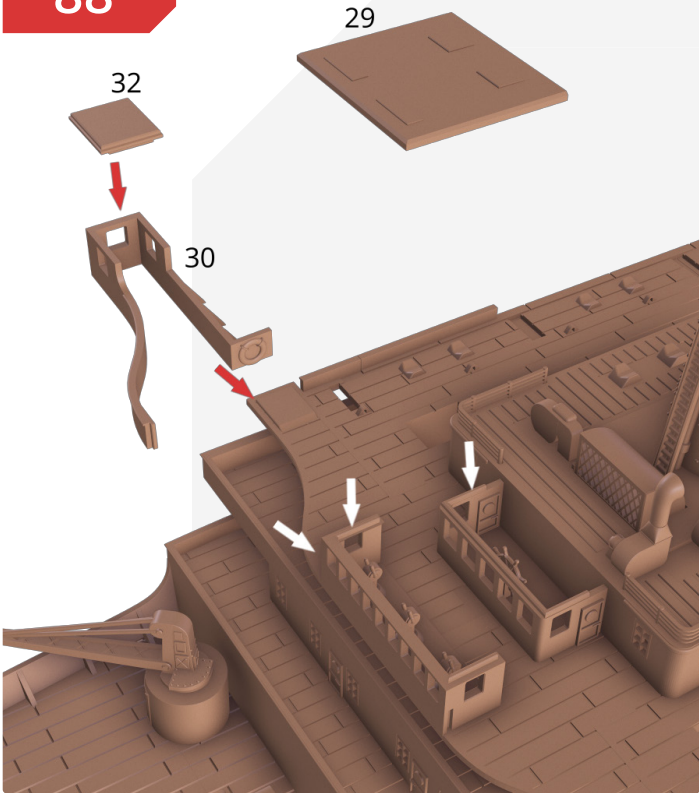

89

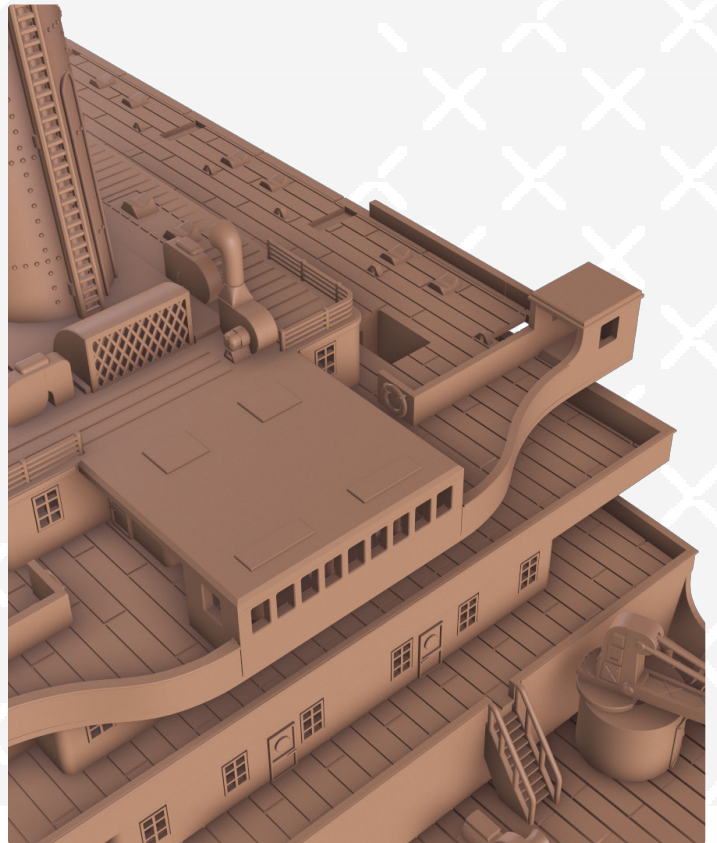
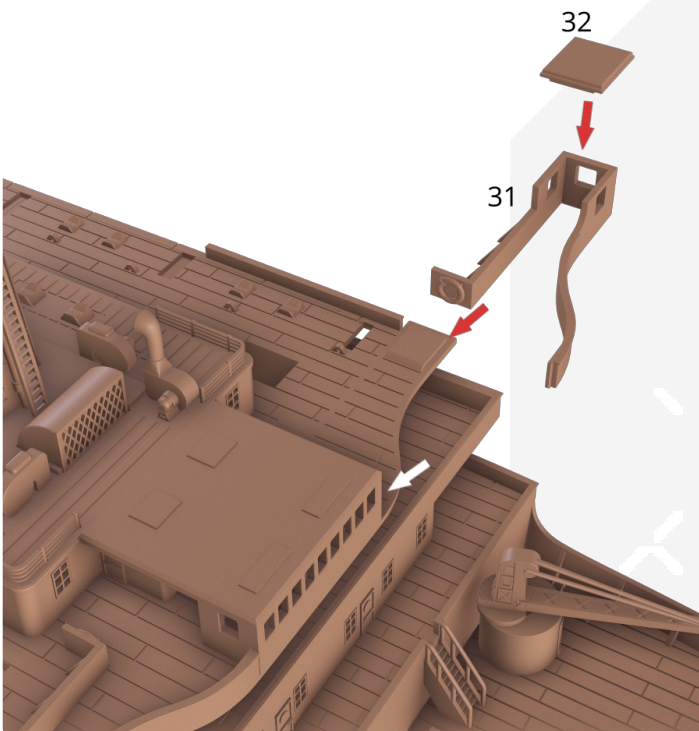

90

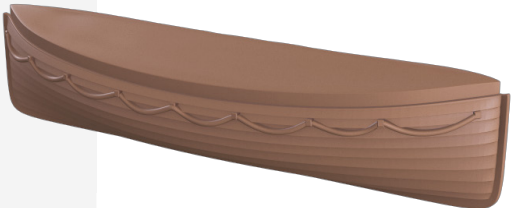

91

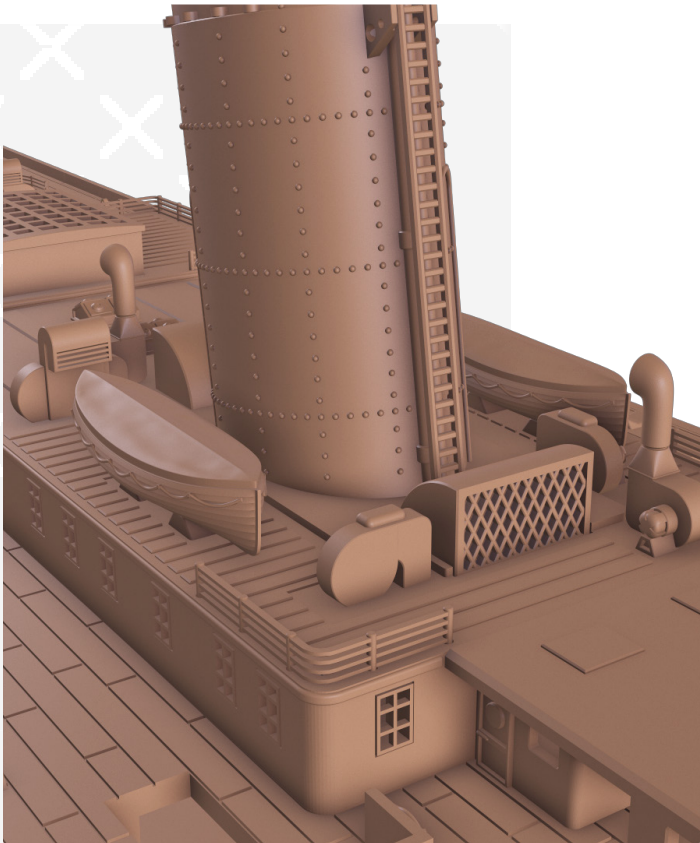
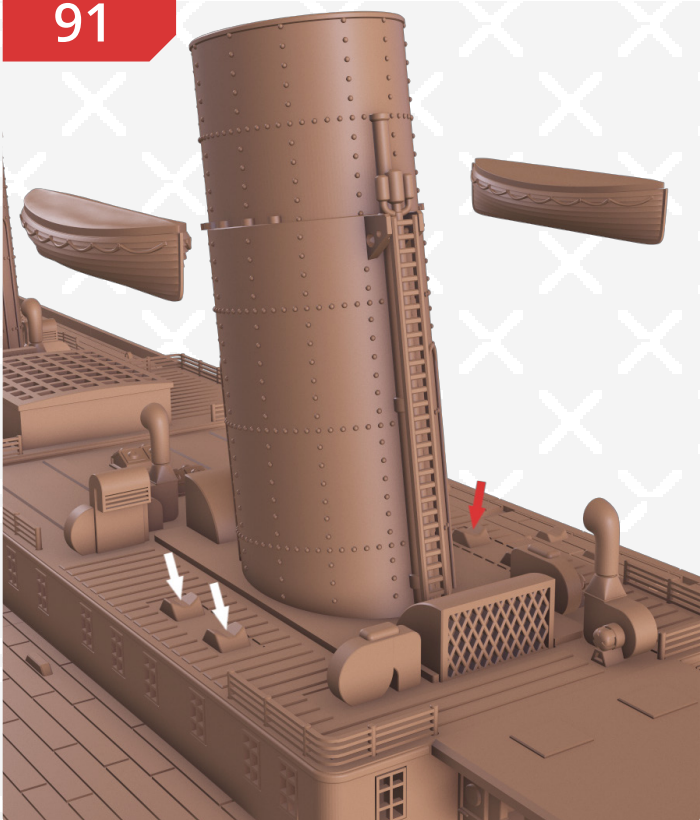

92

59x2

58x3

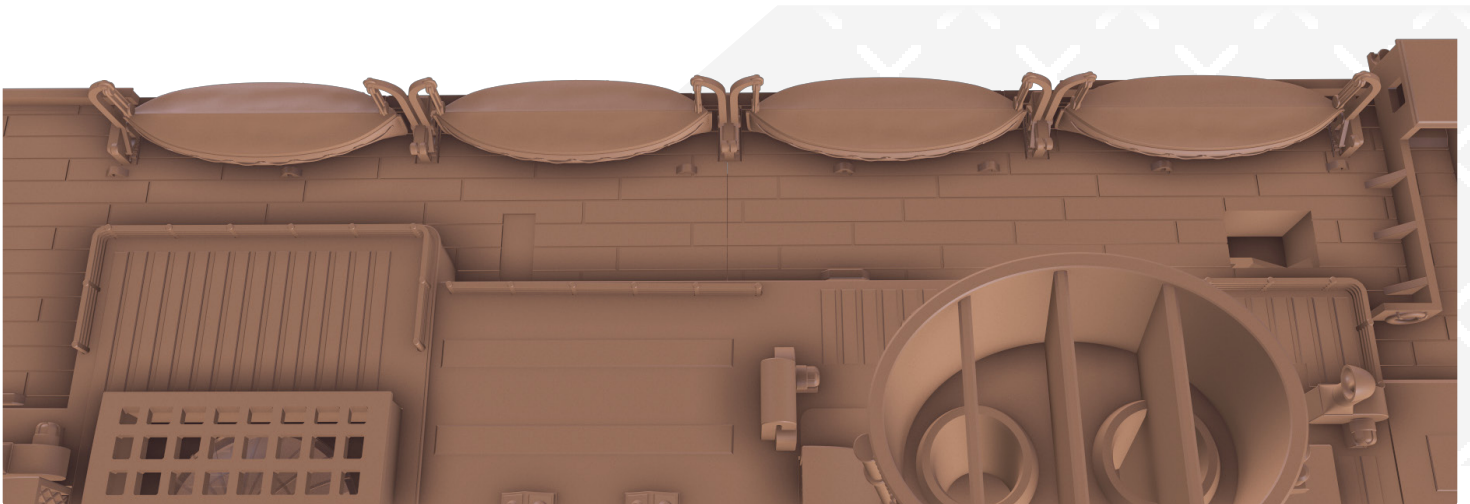
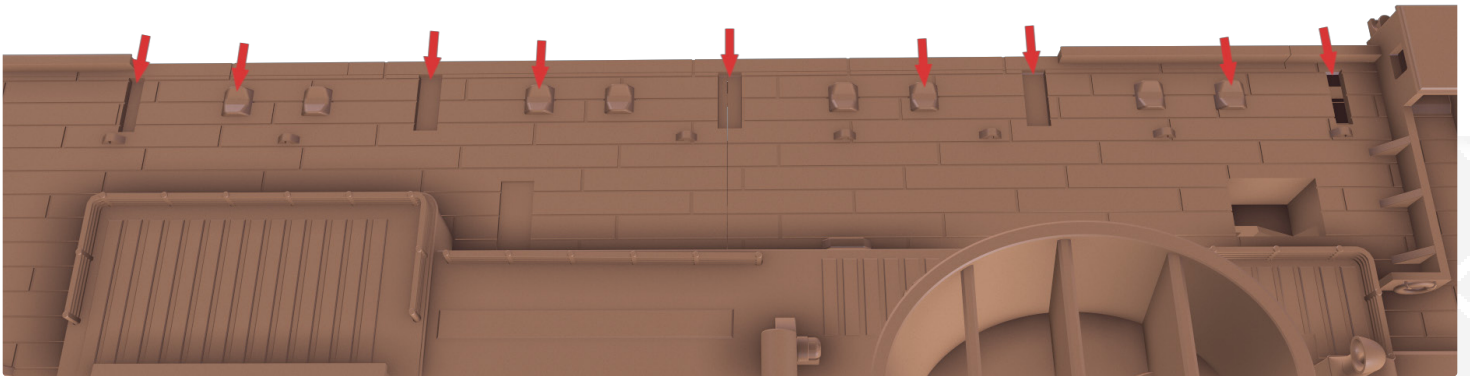

93

59x2

58x3

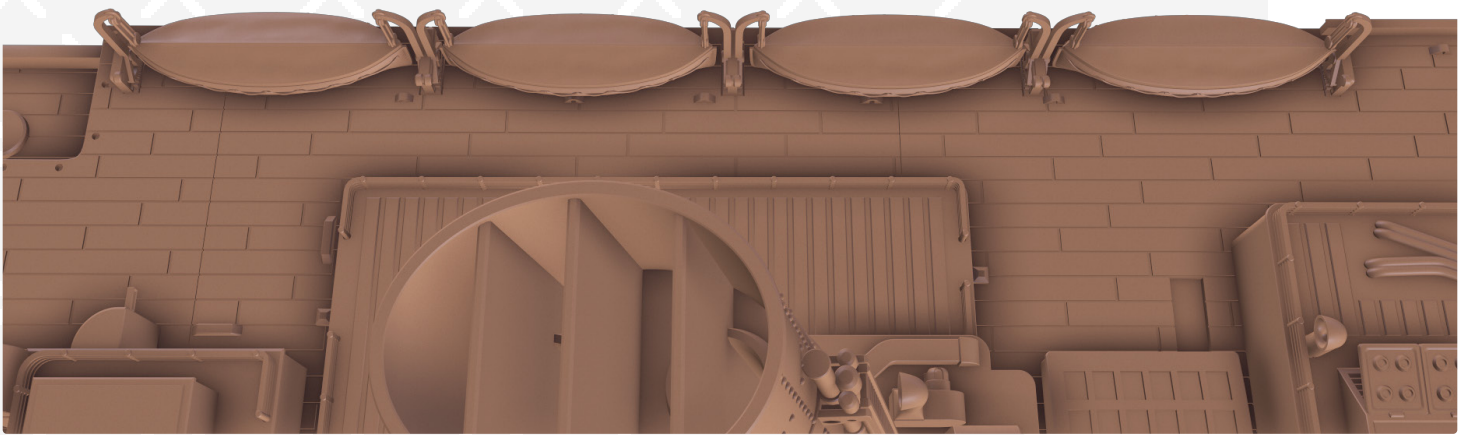
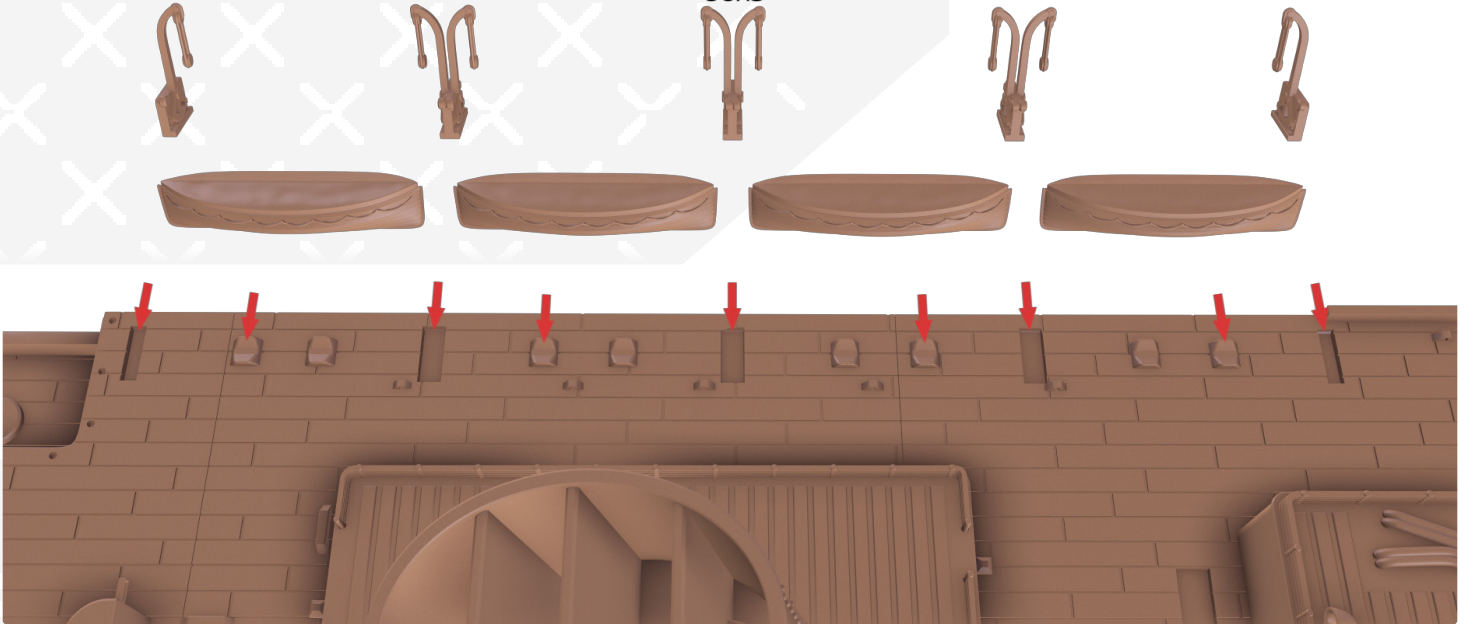

94

59x2

58x3

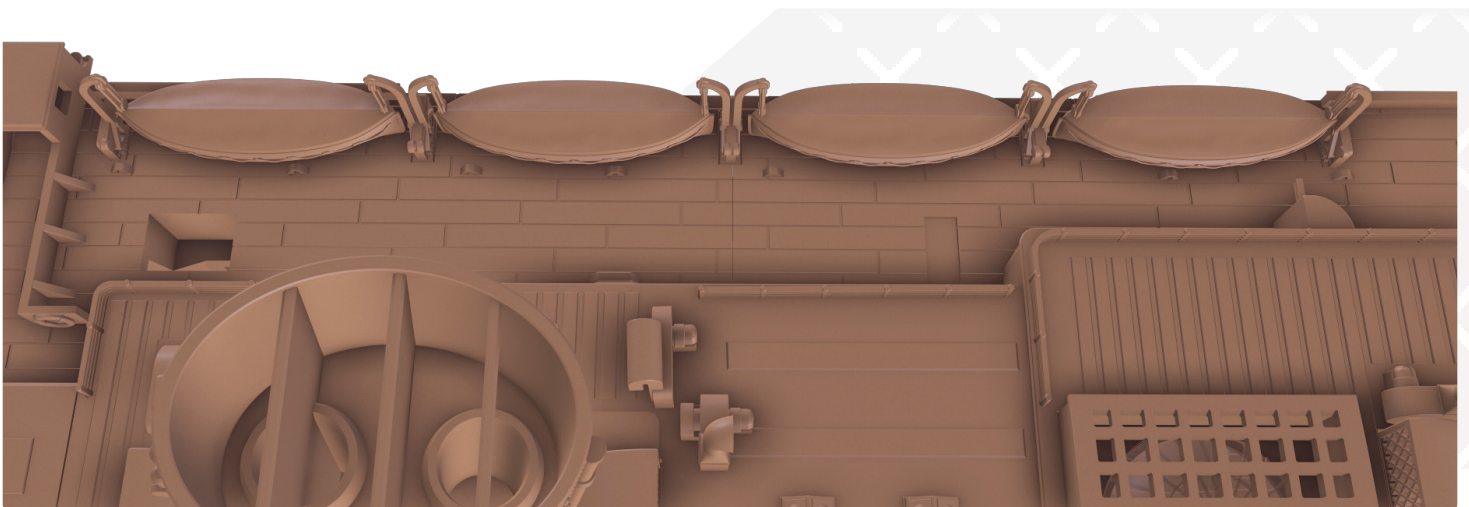
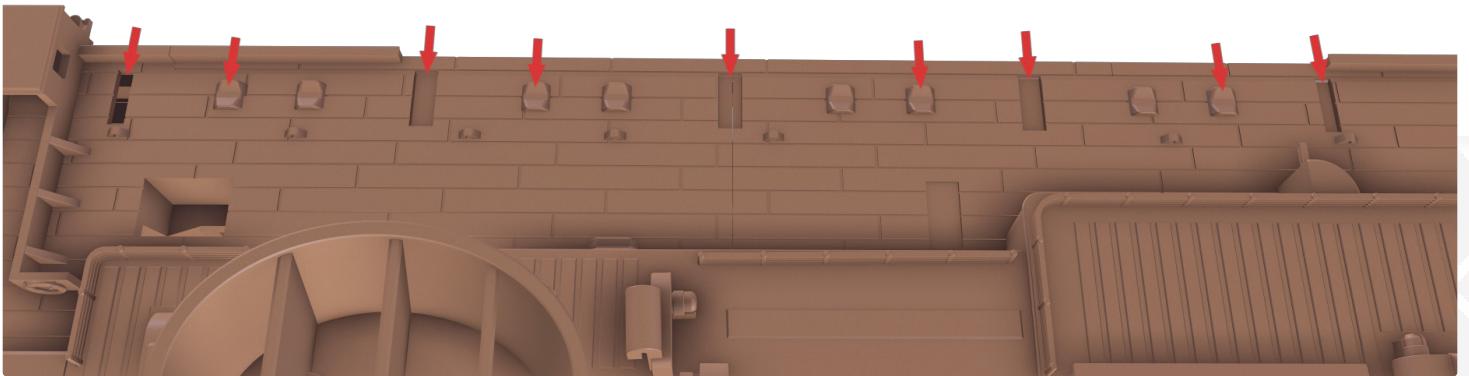

95

59x2

58x3

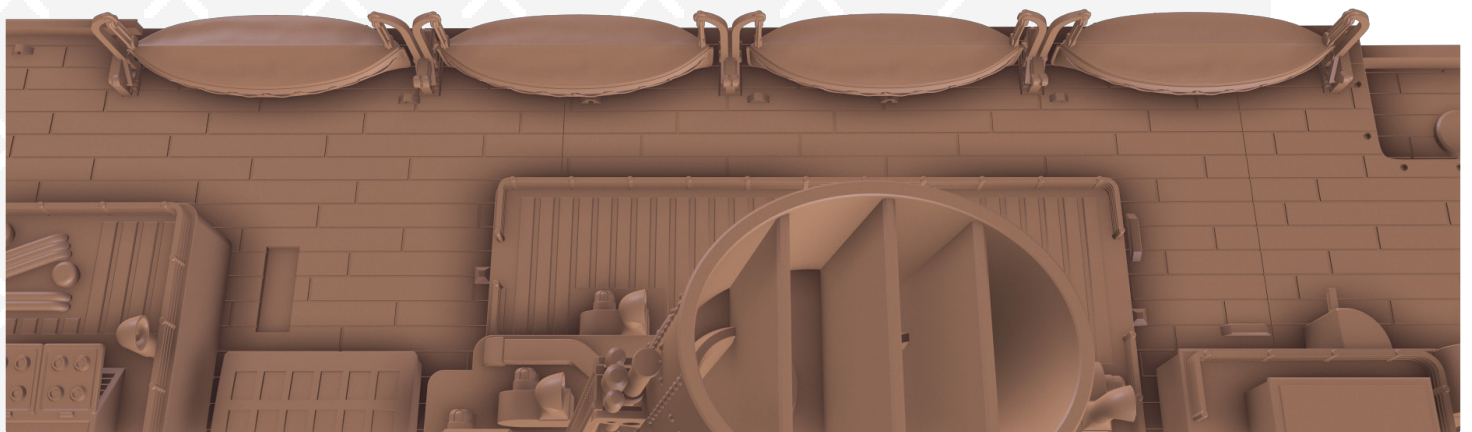
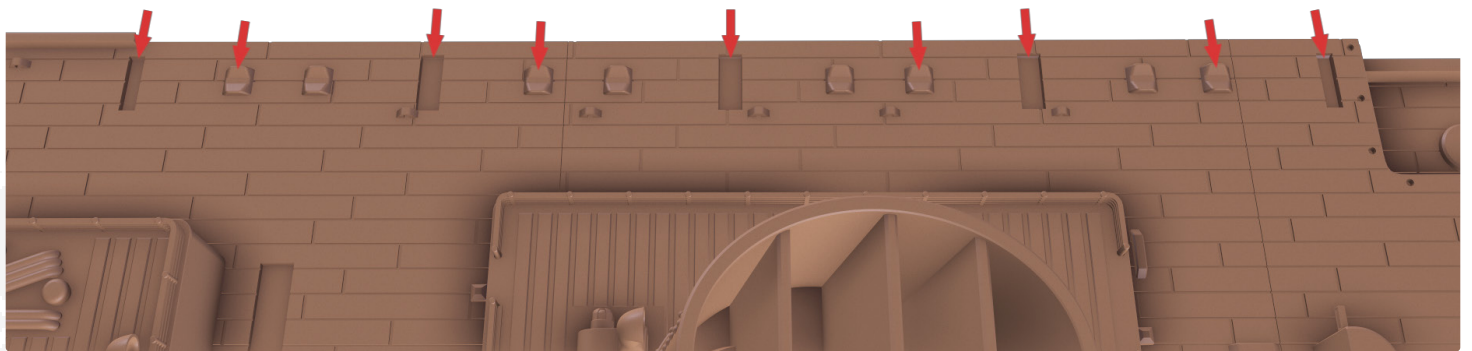

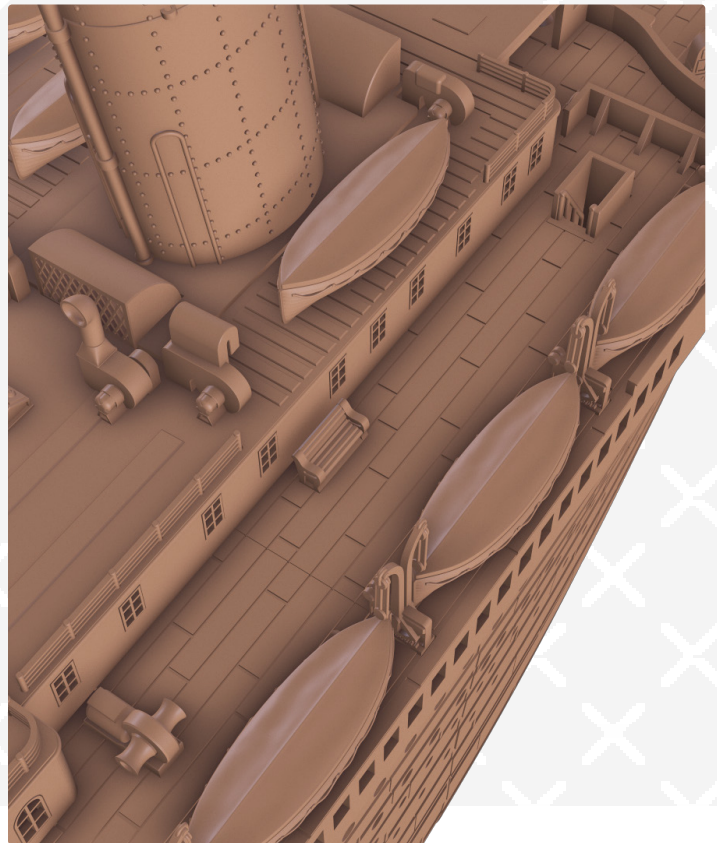
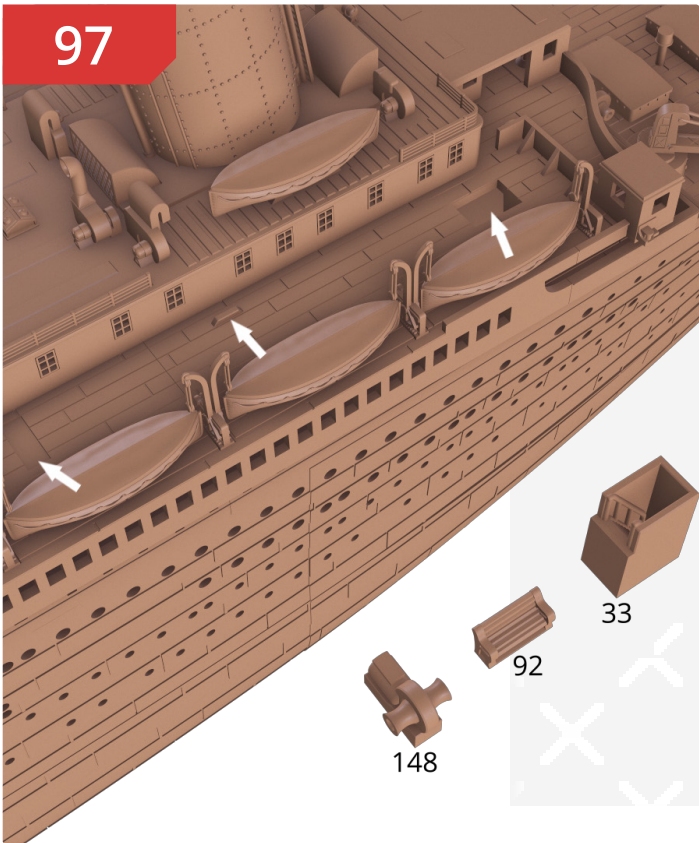
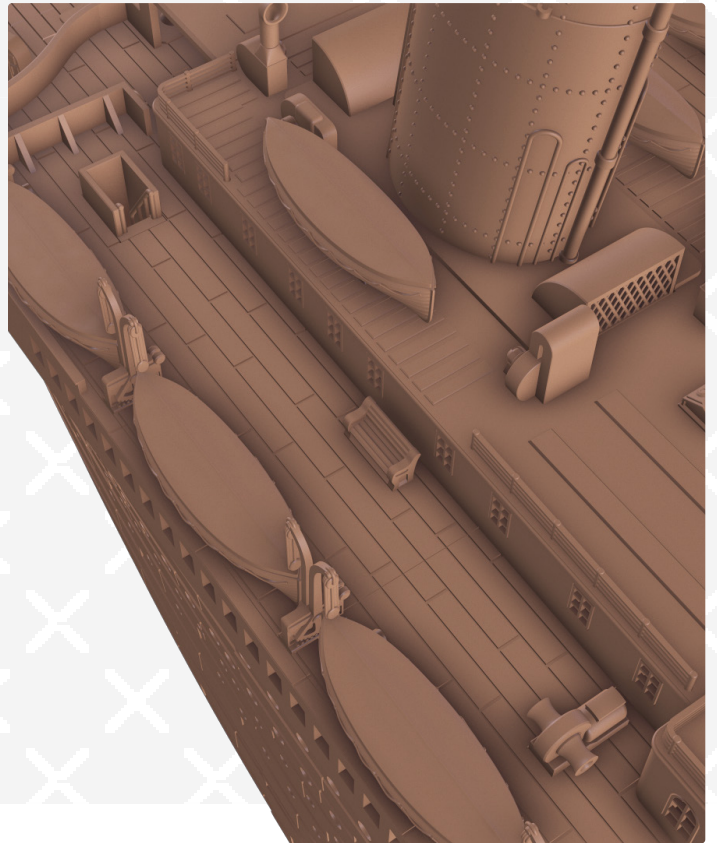
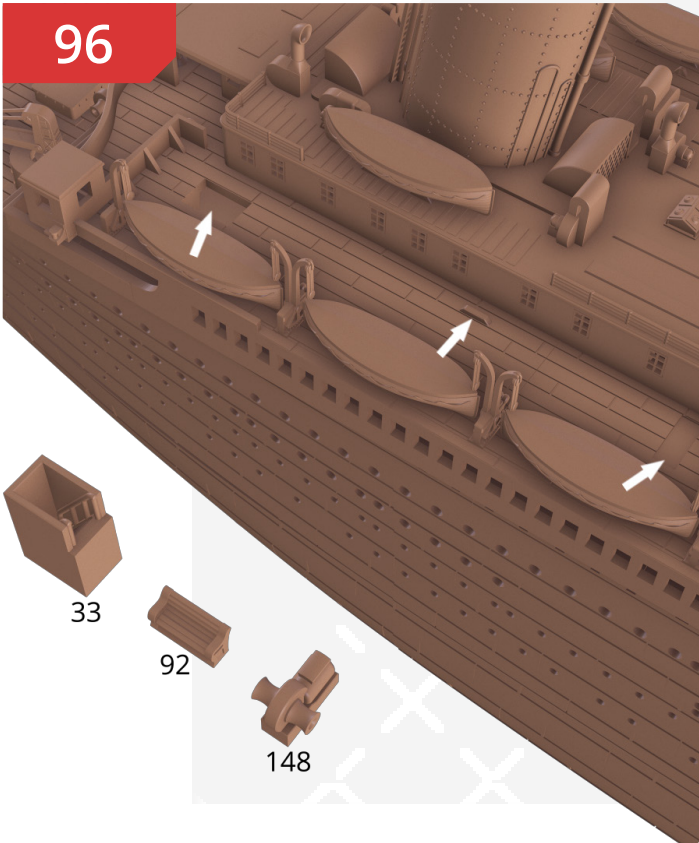

98

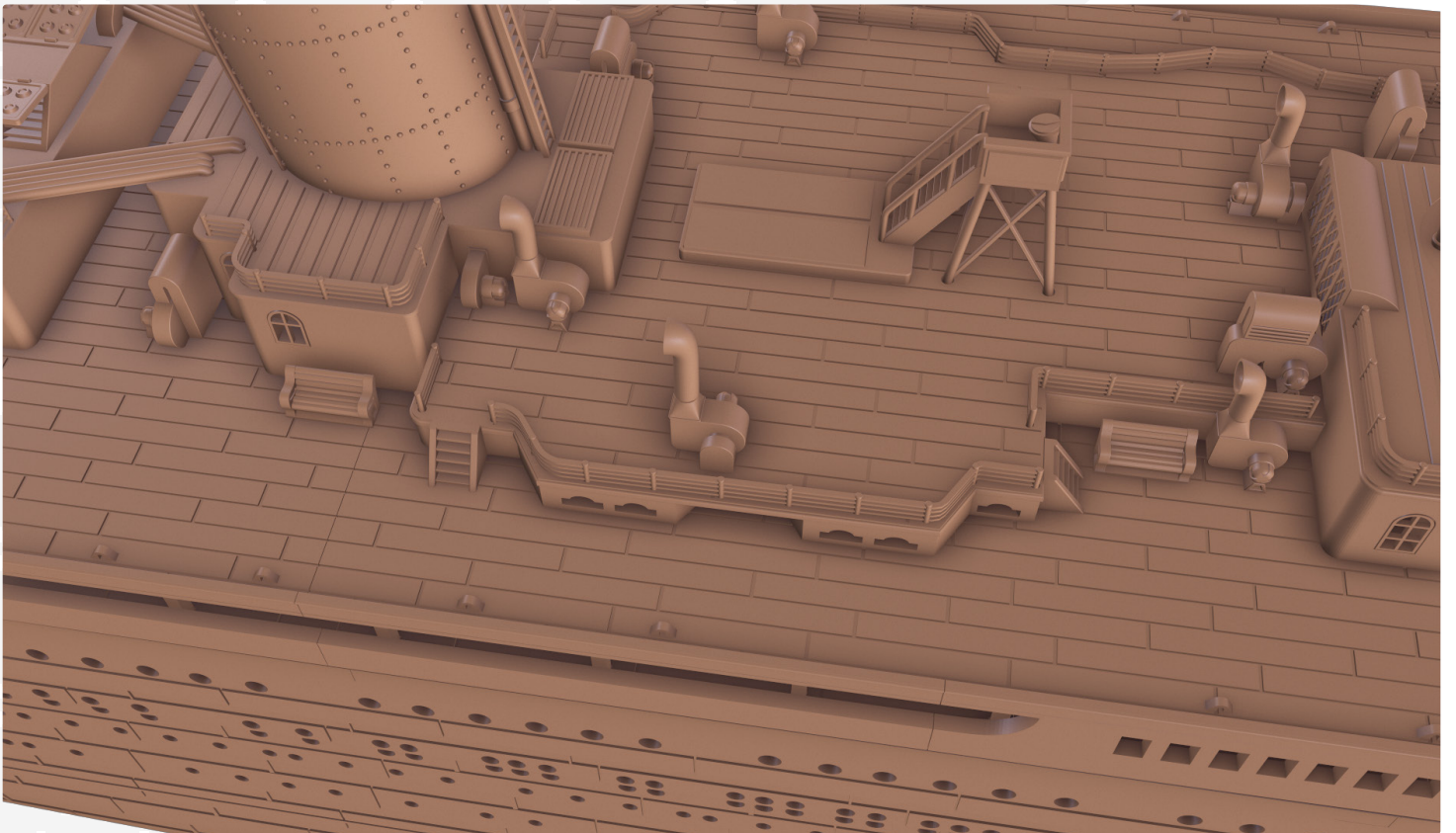
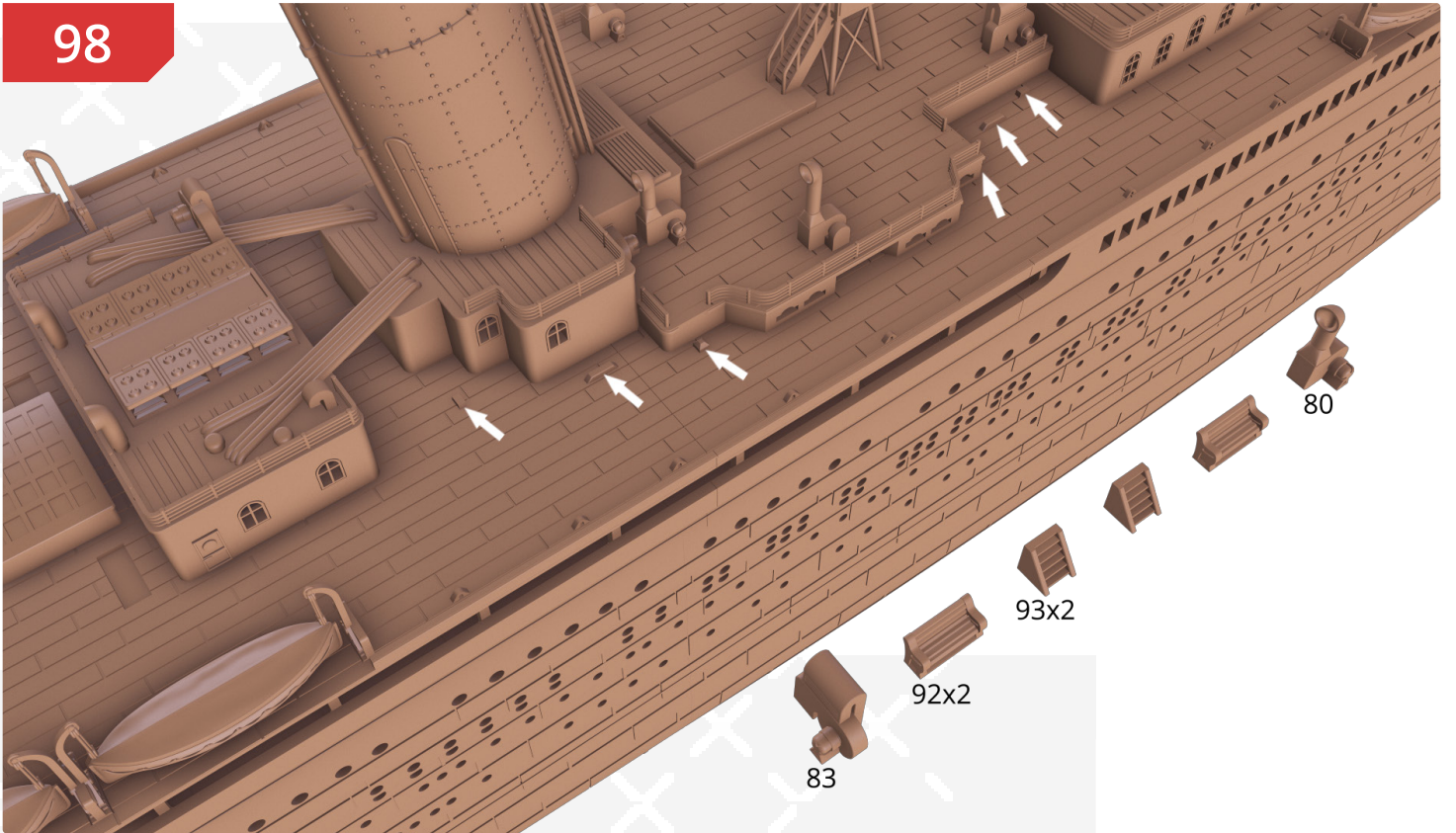

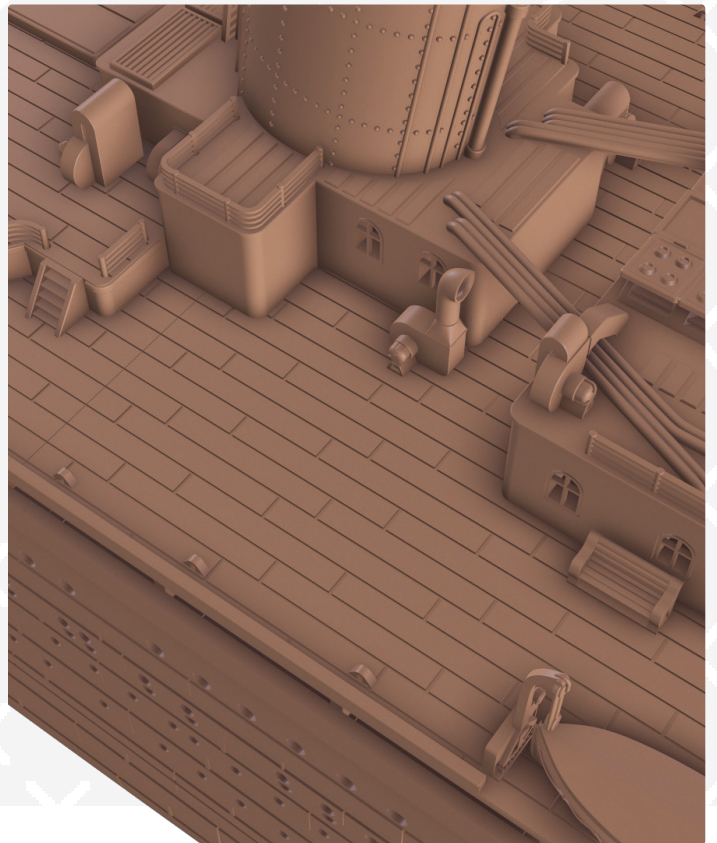
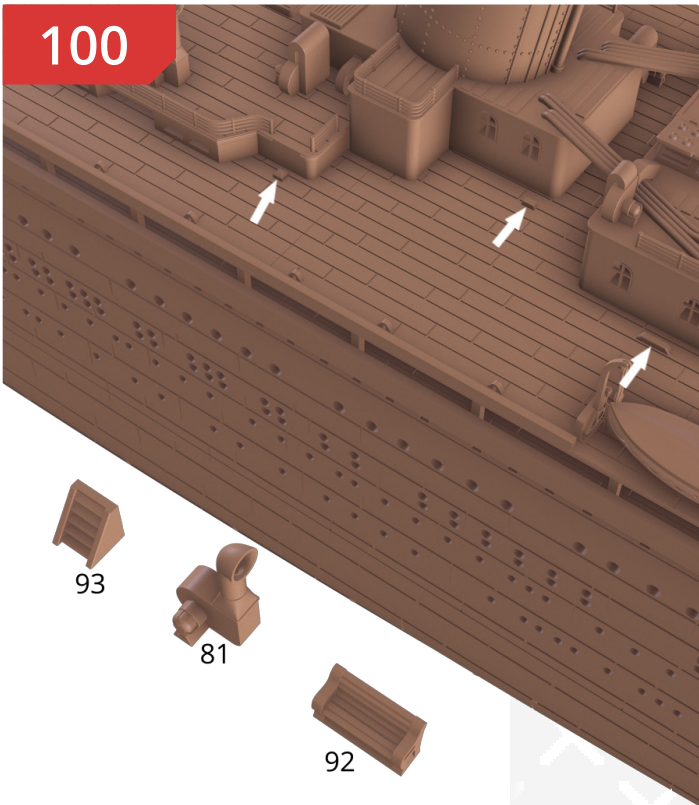
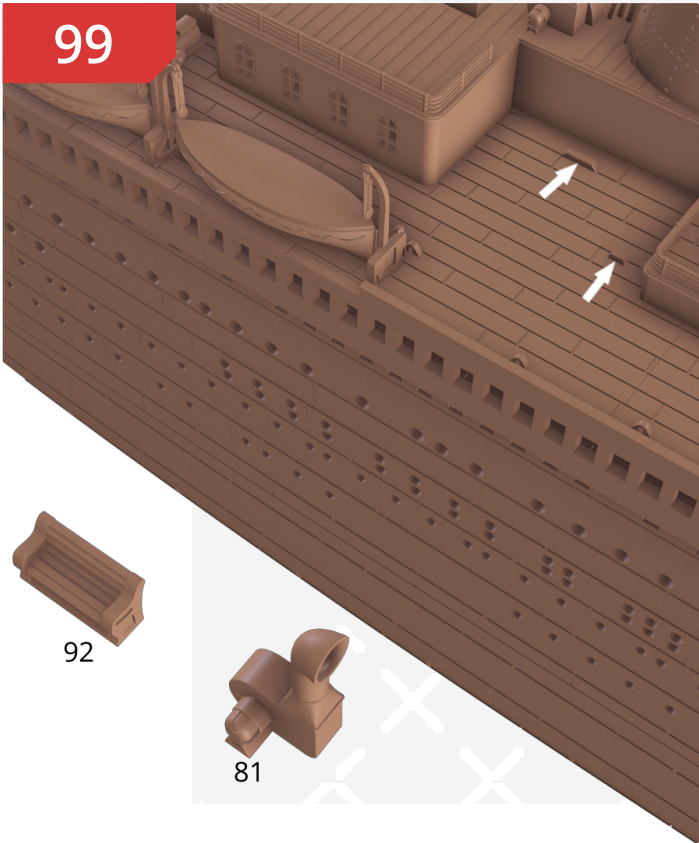

101

148x2

93x2

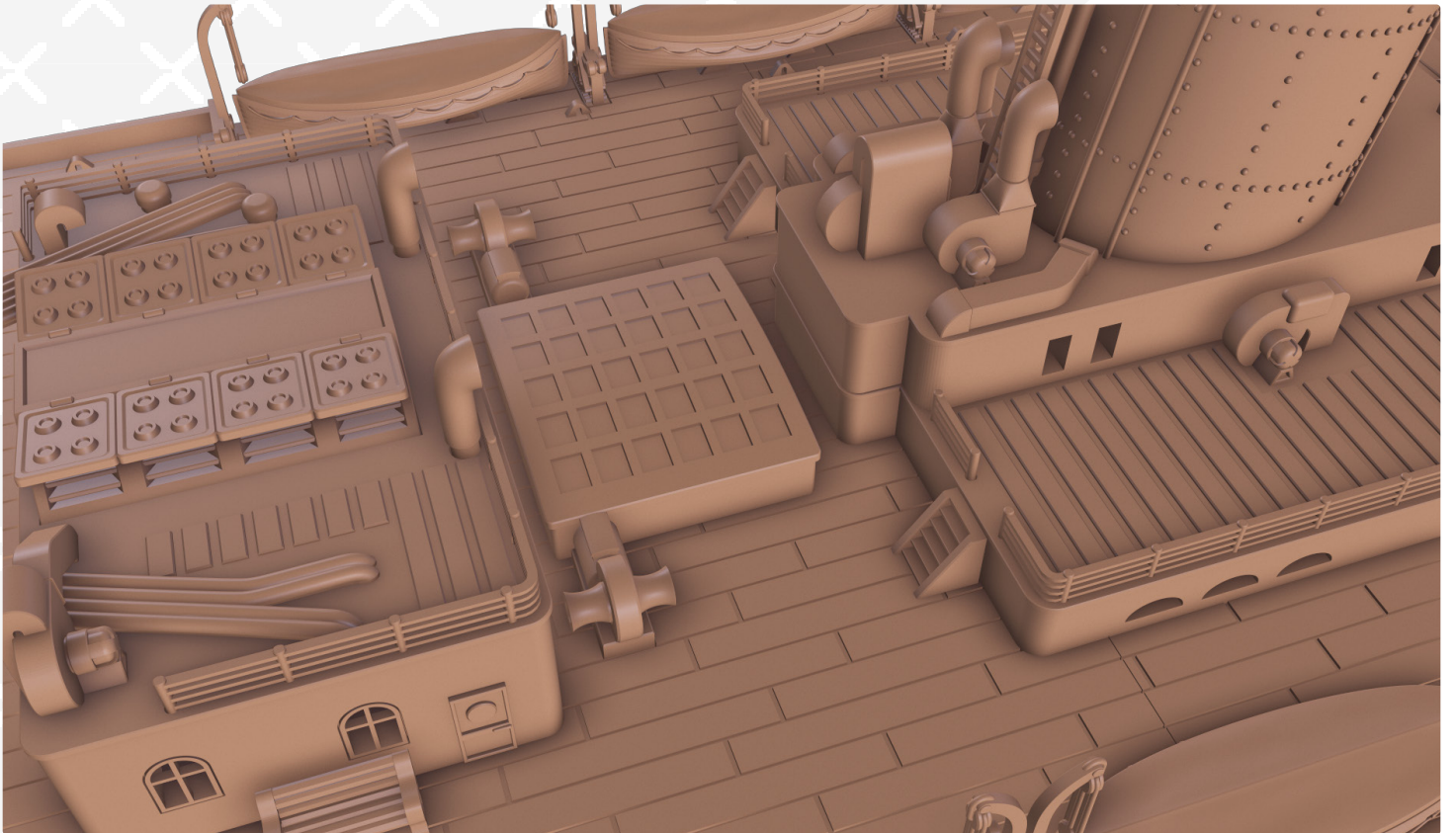
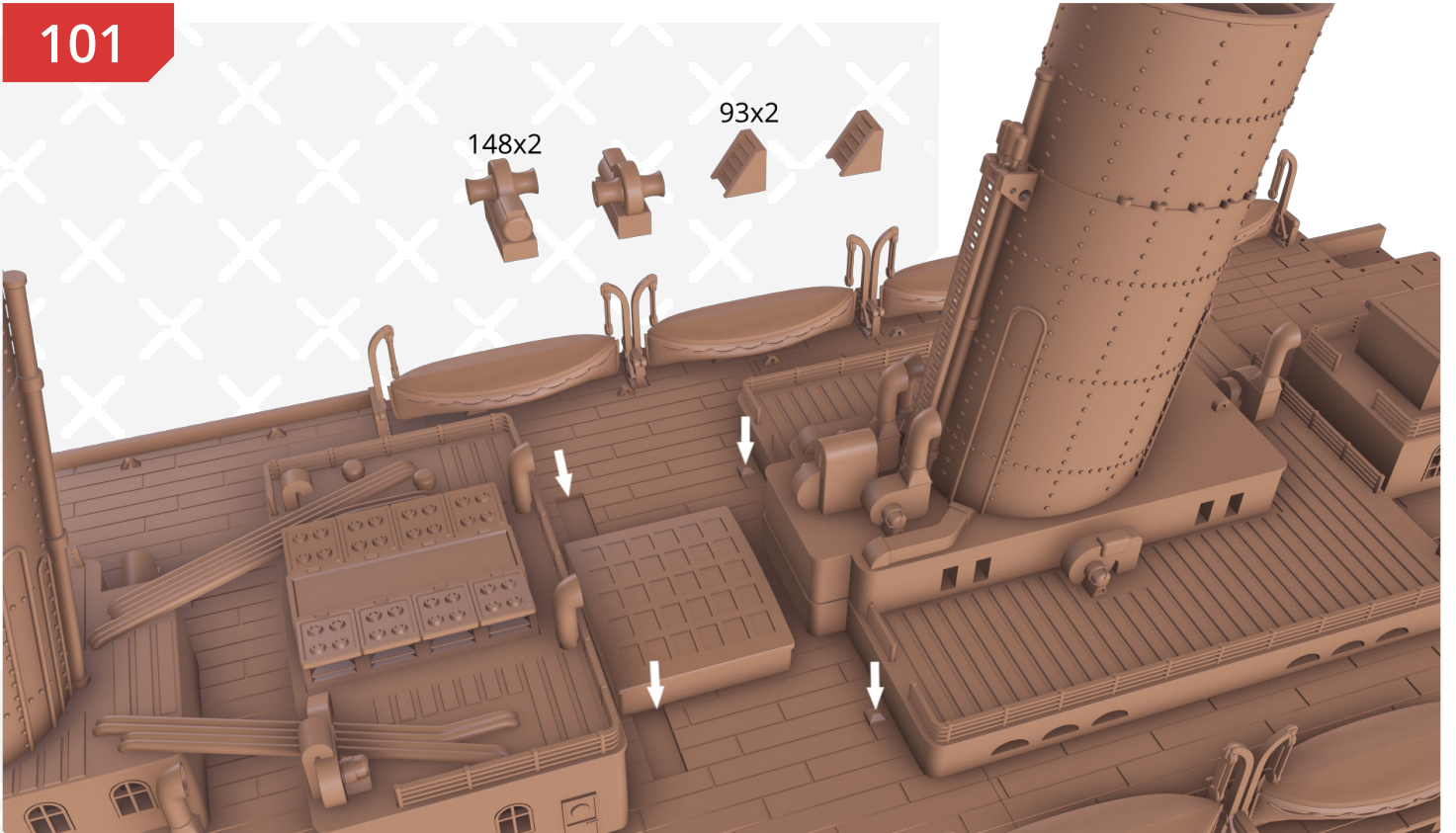

102

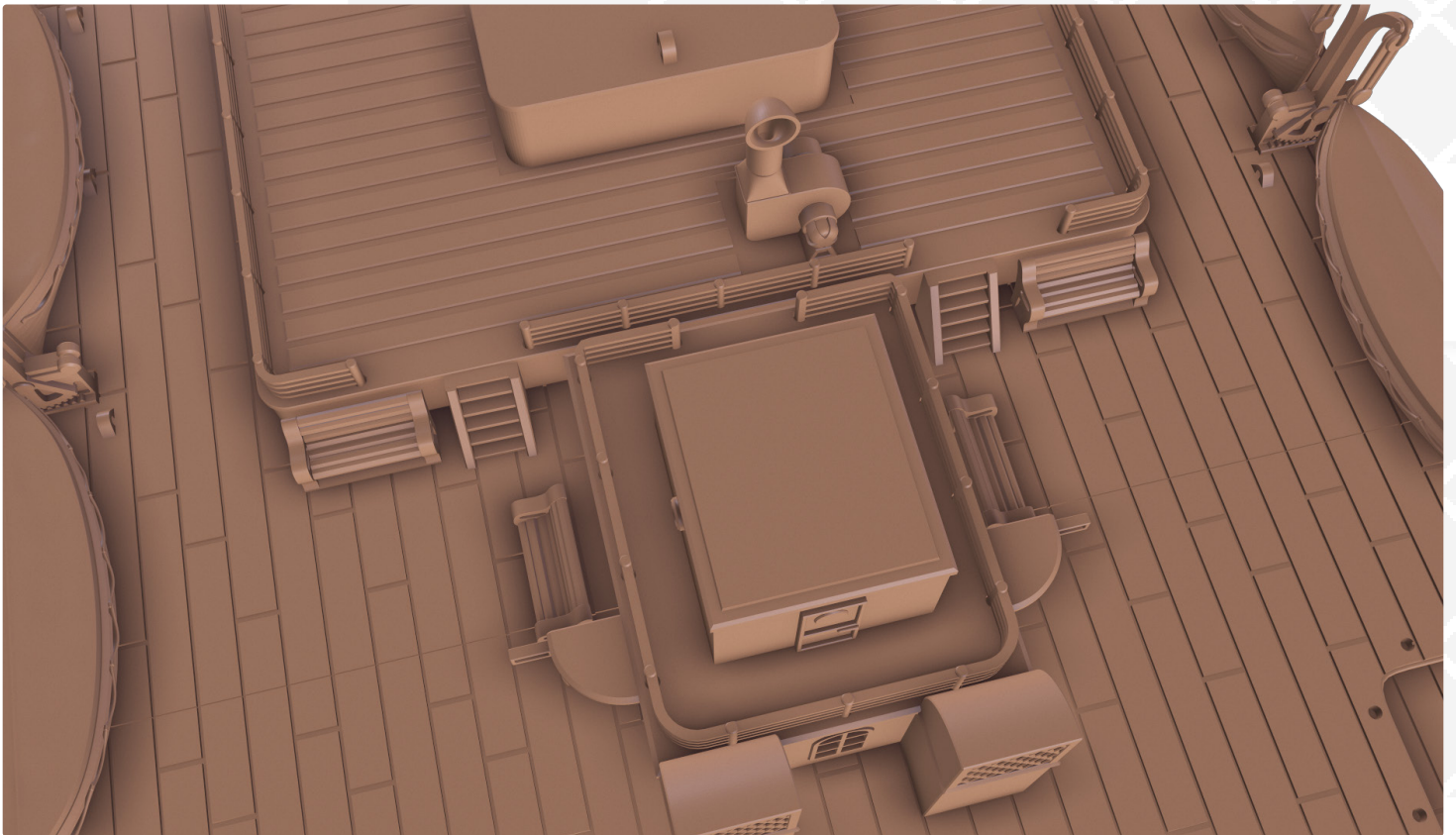
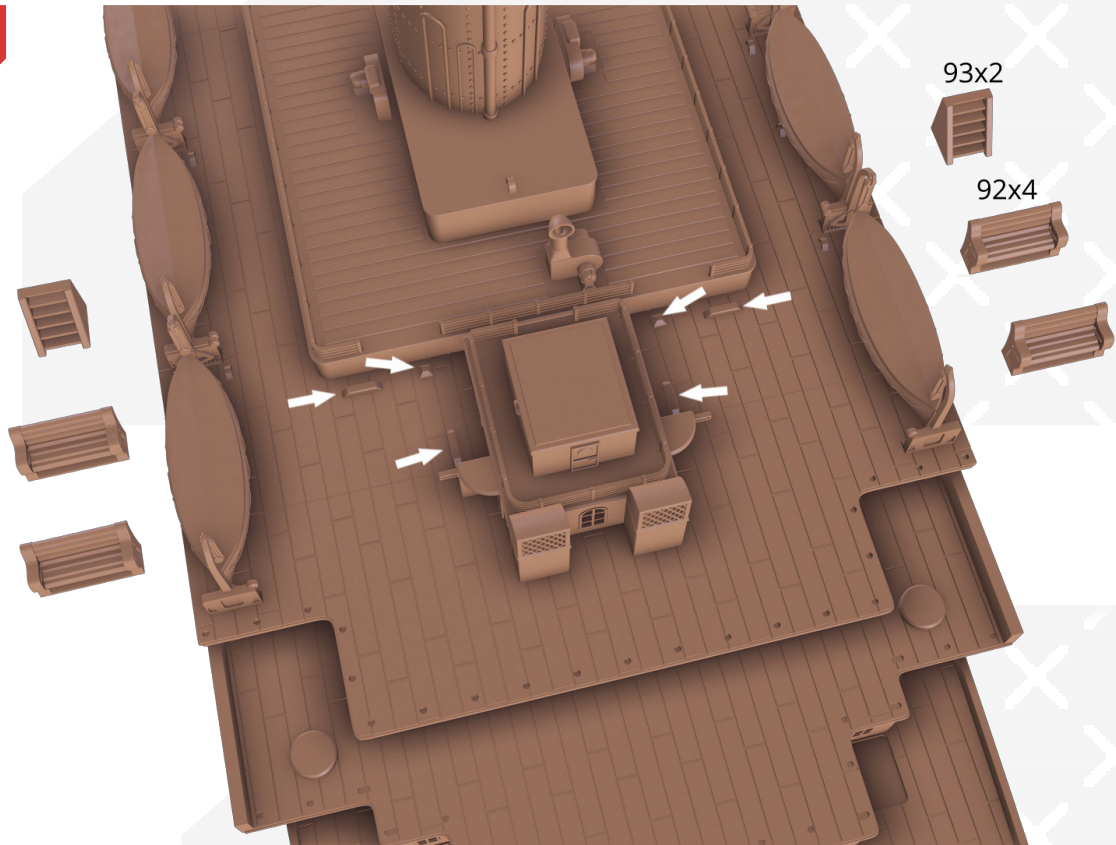

103

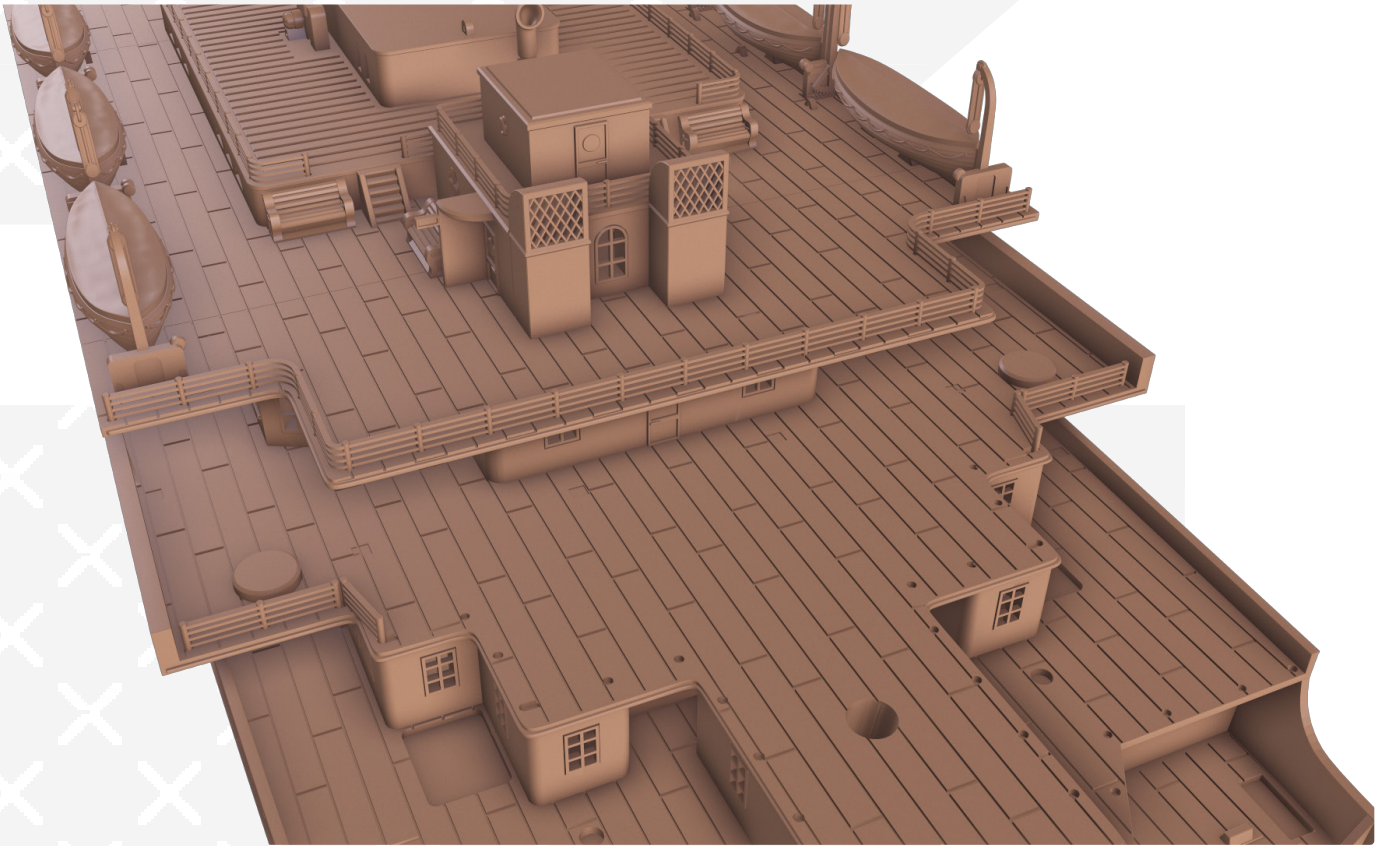
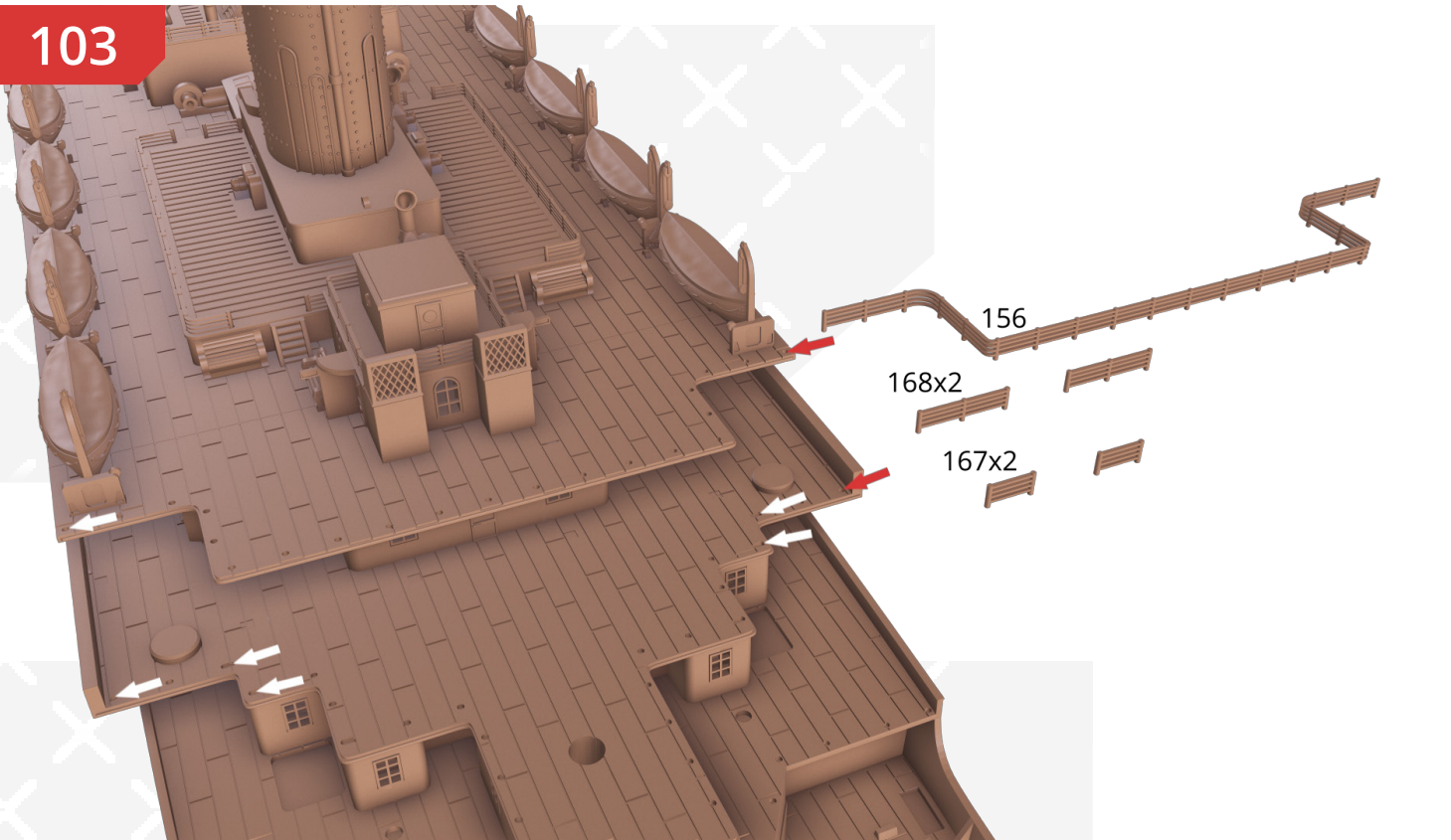

104

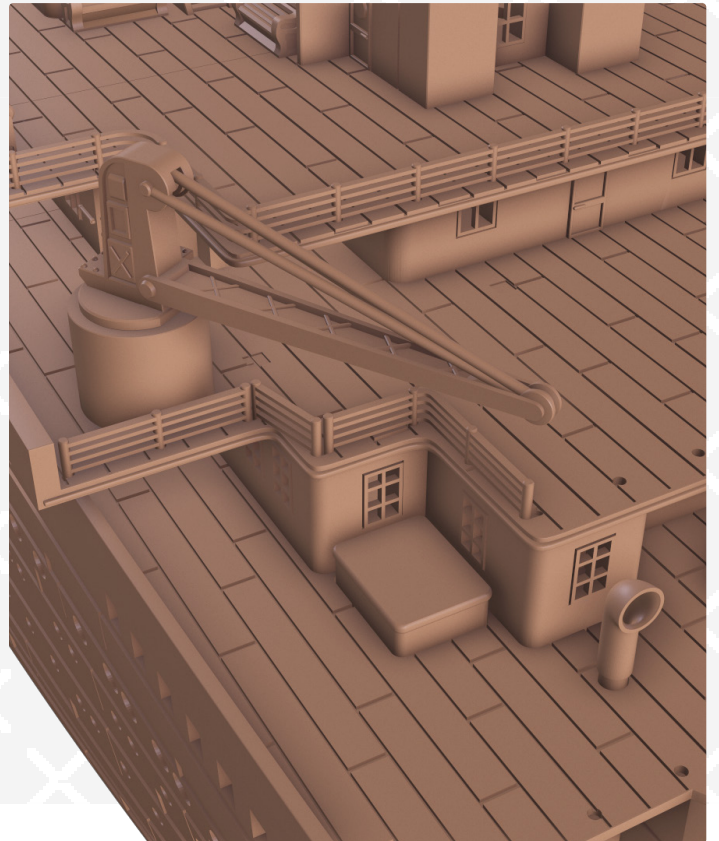
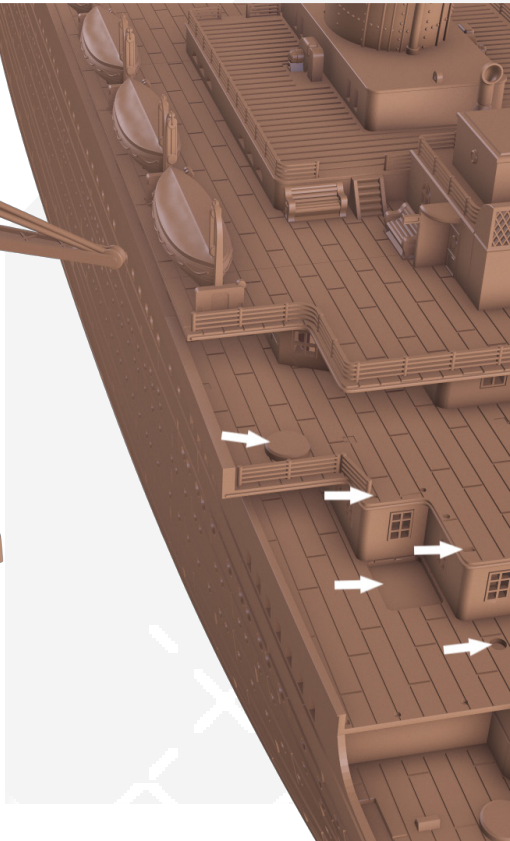
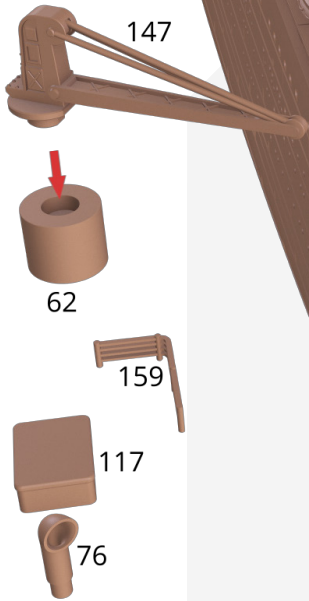

105

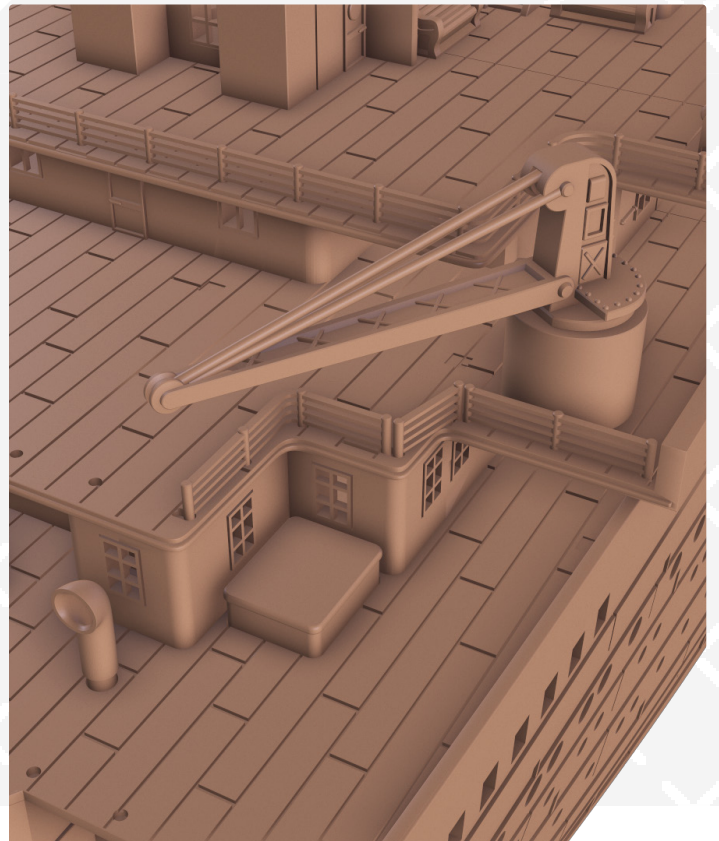
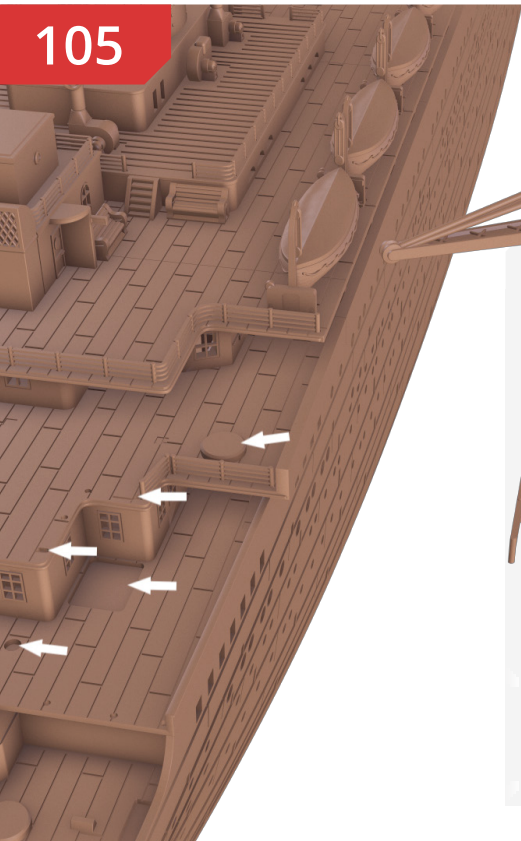
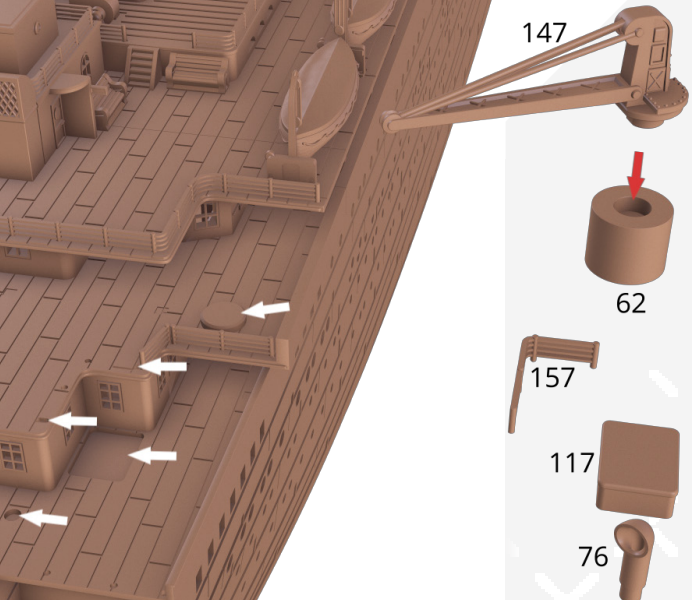

106

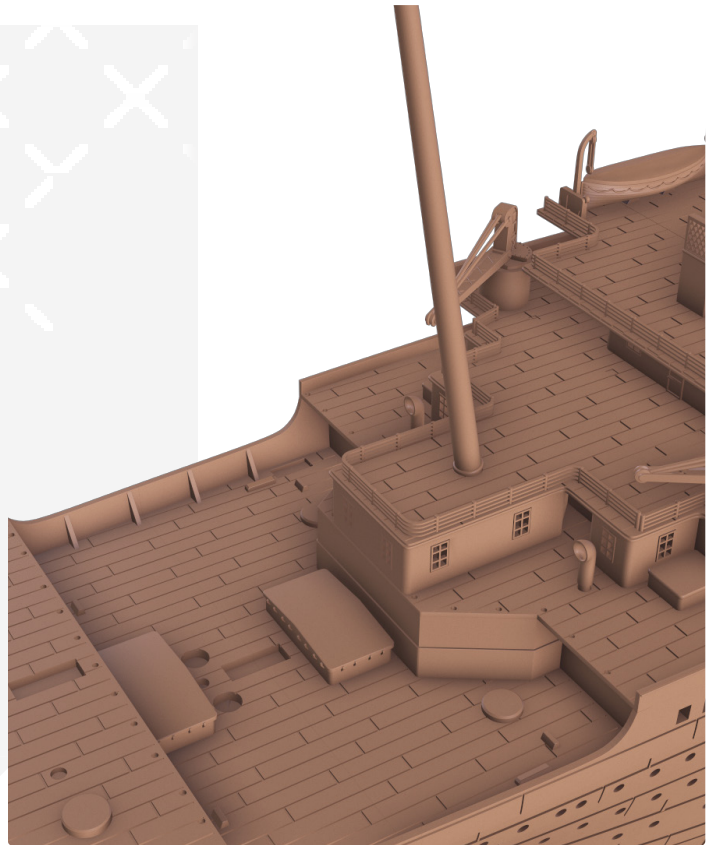
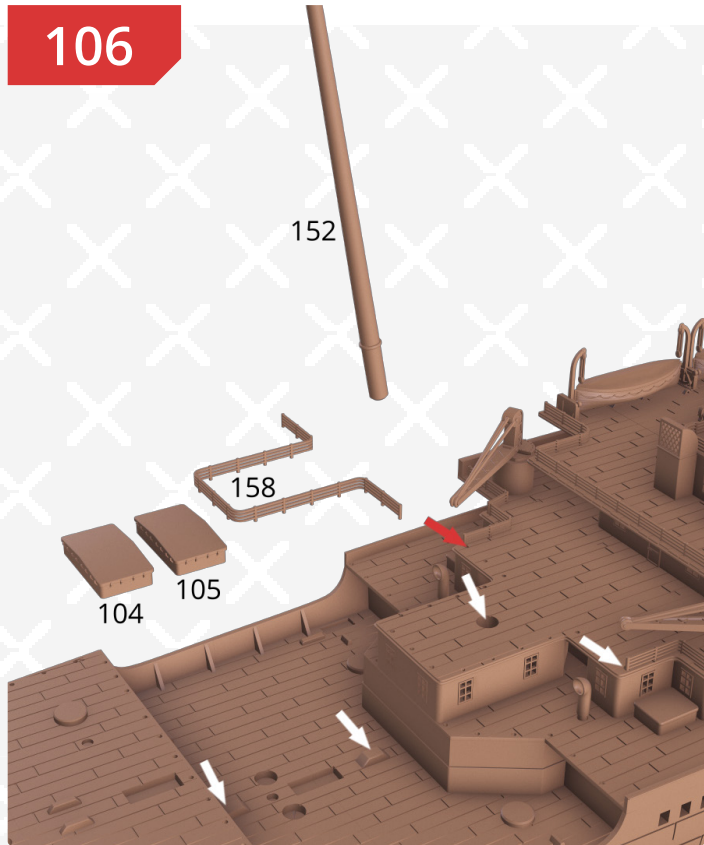

107

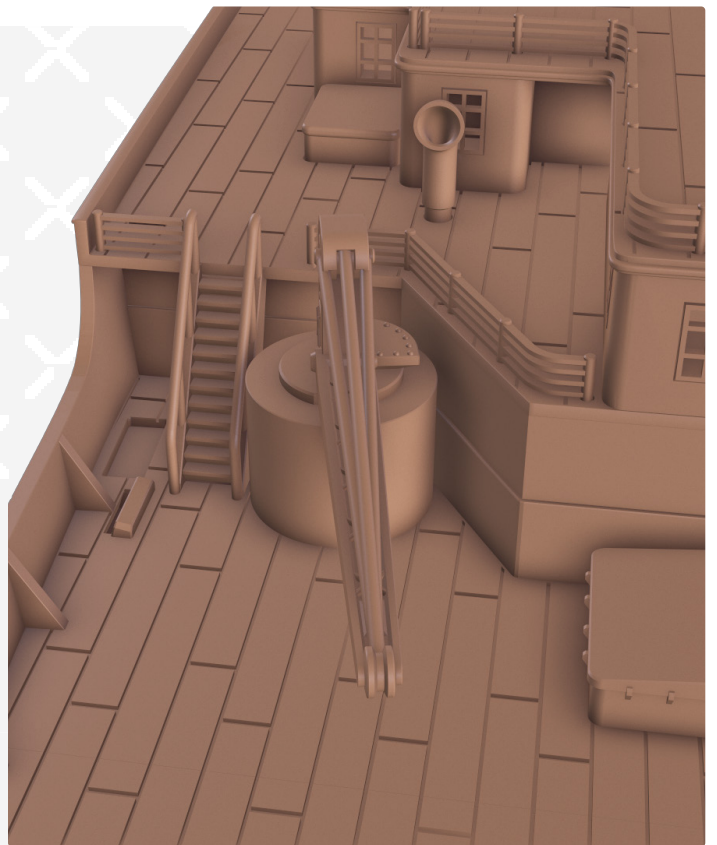
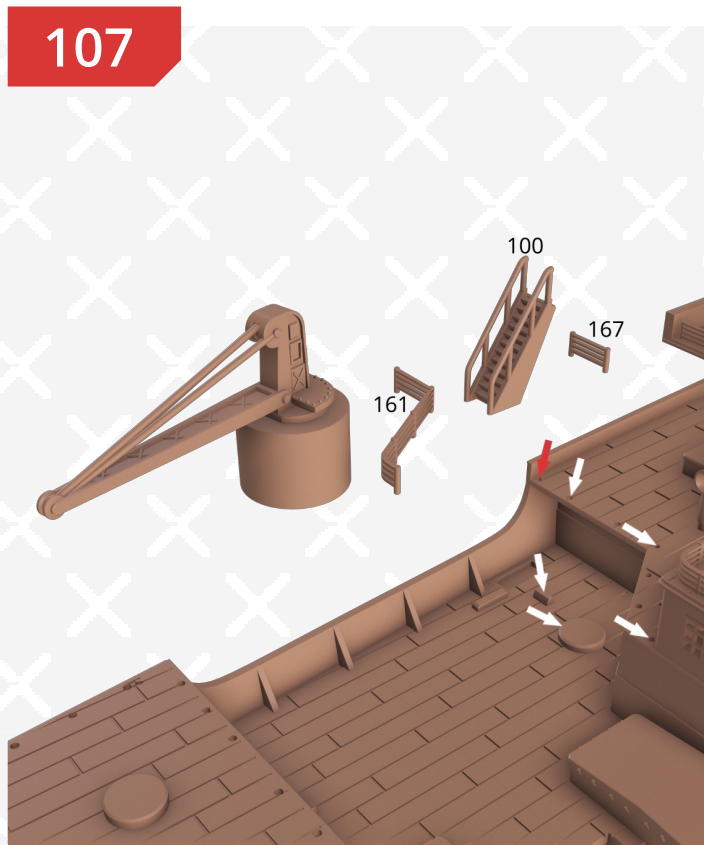

108

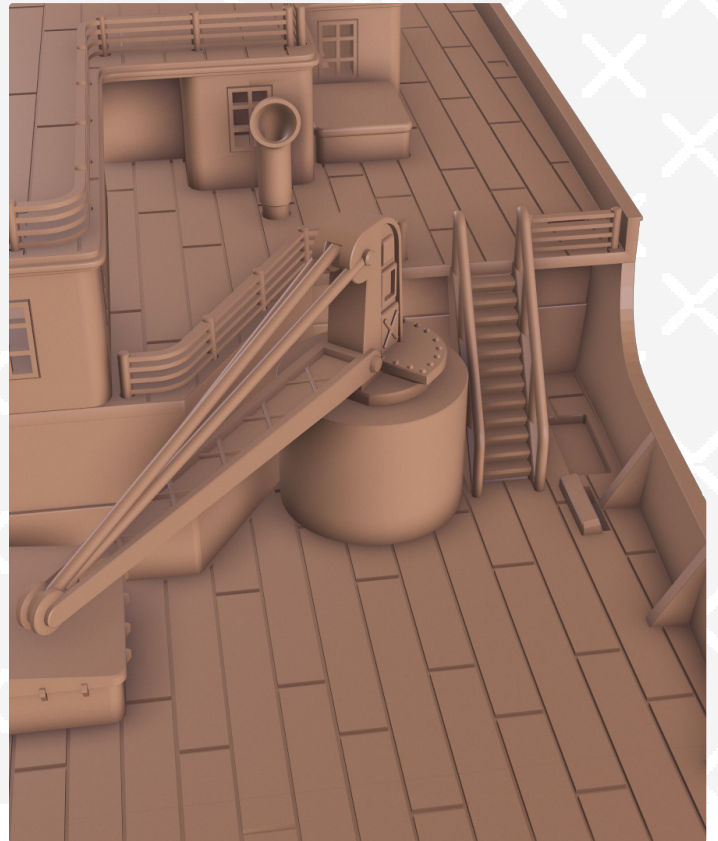
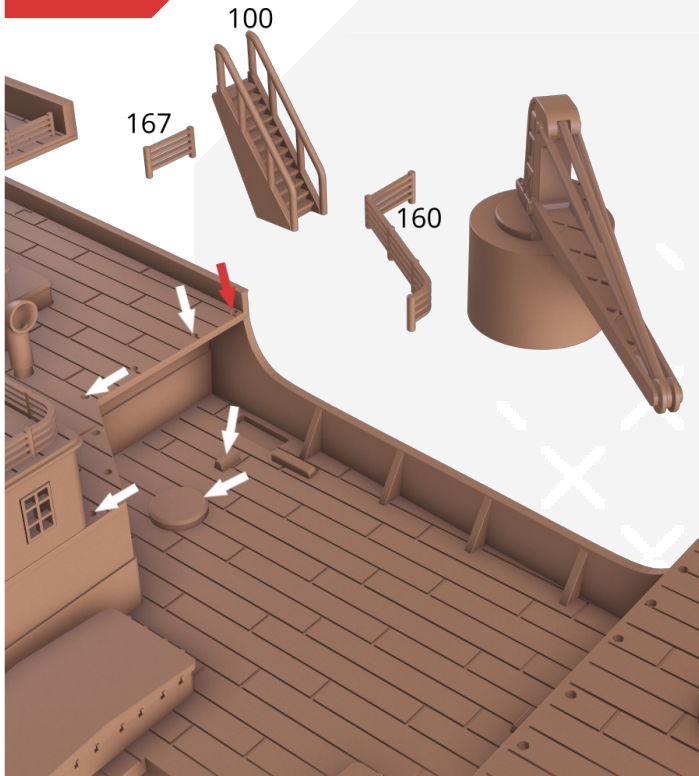

109

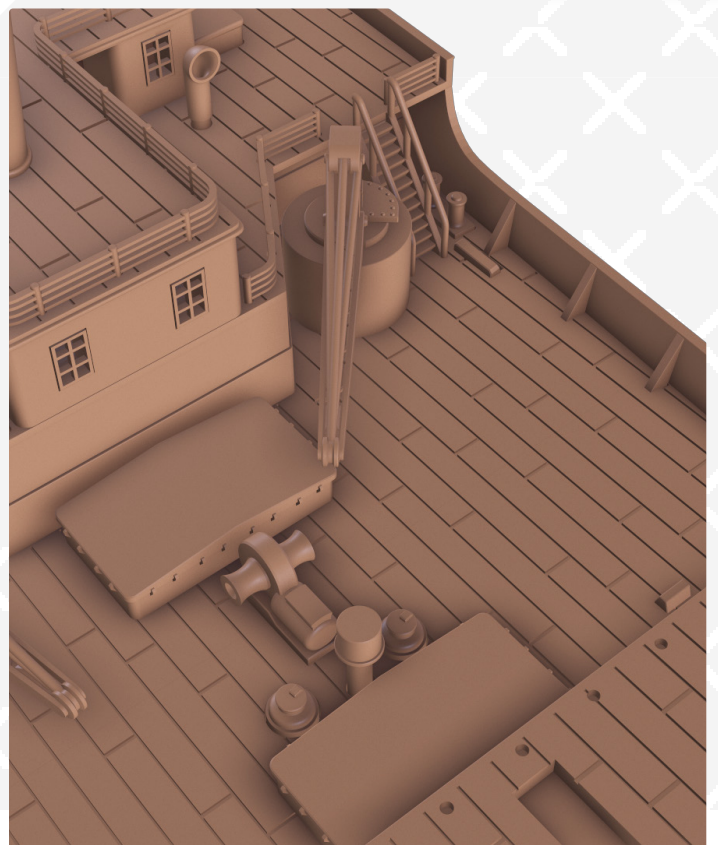
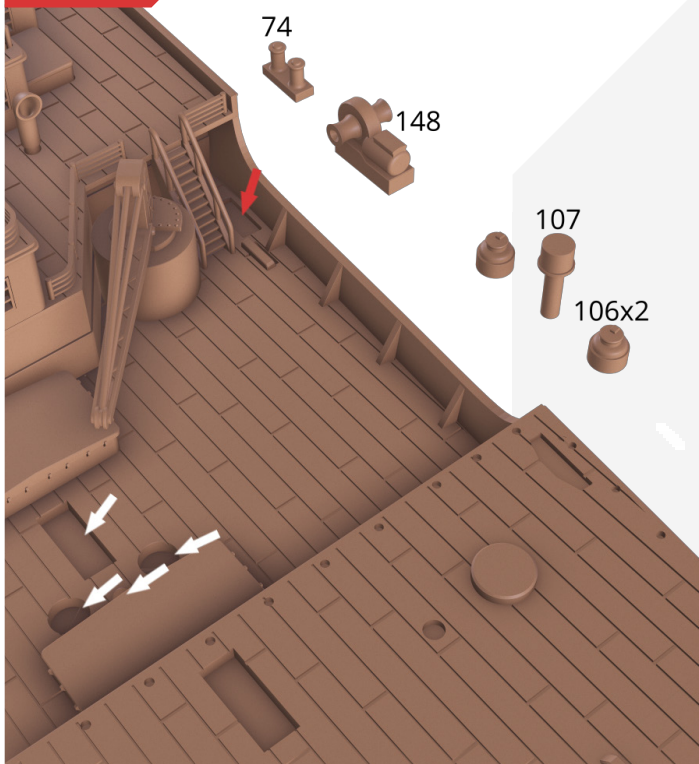

110

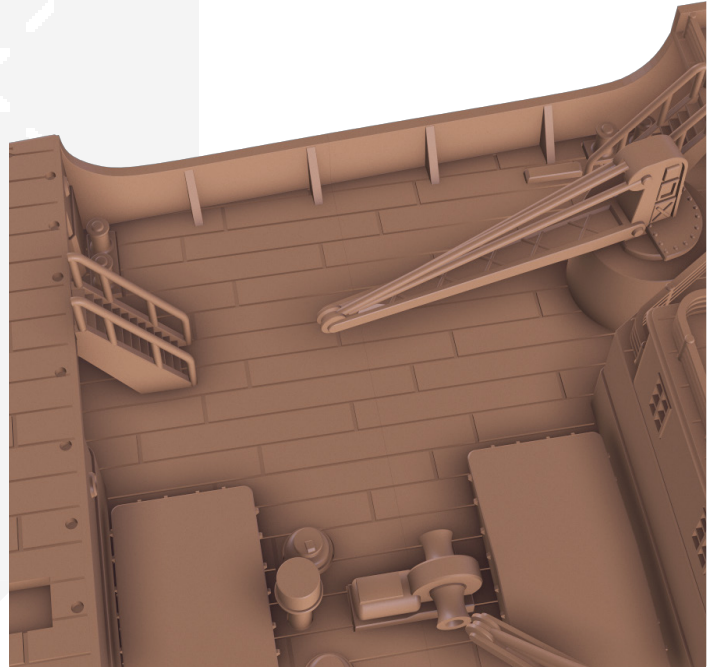
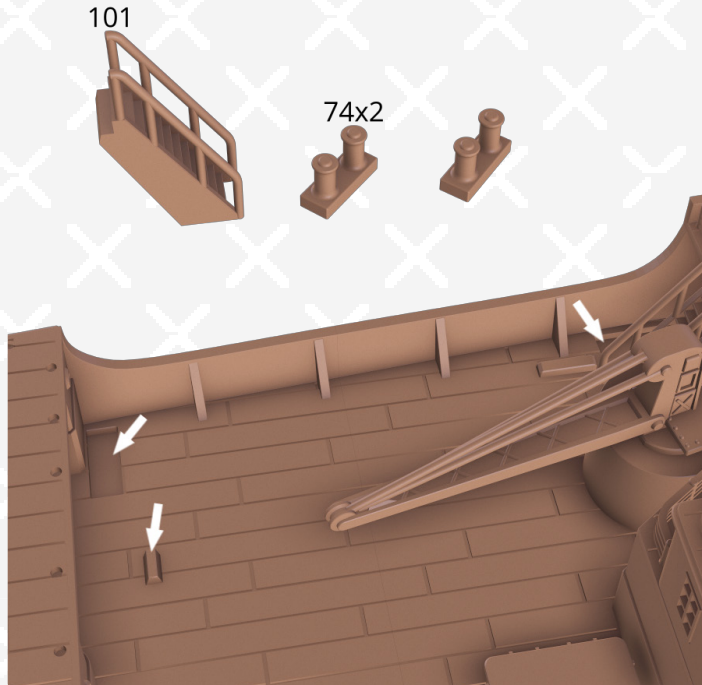

111

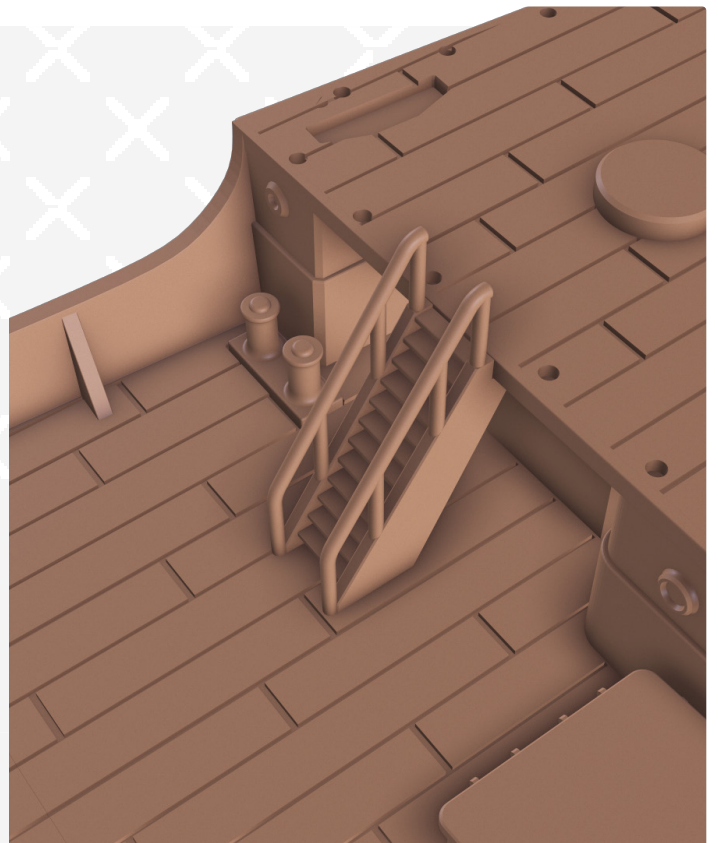
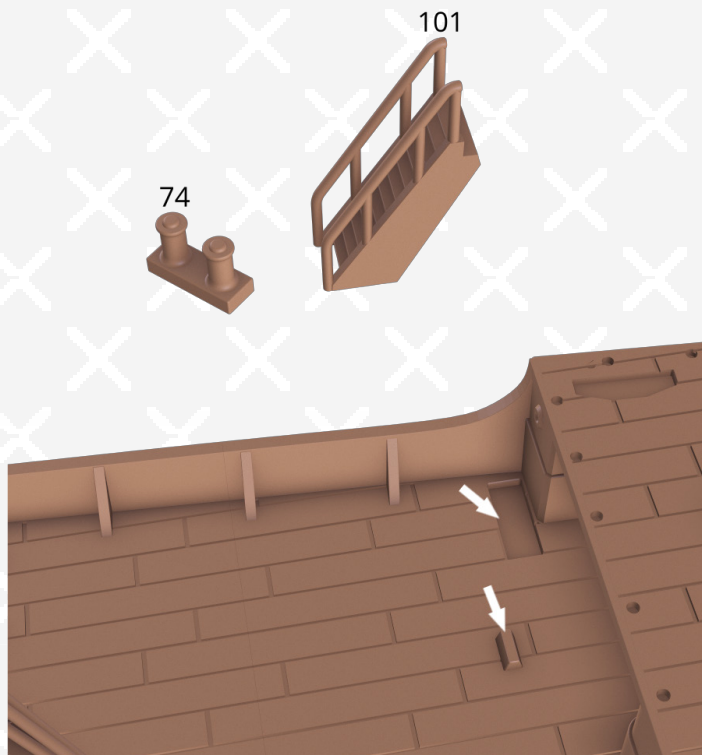

112

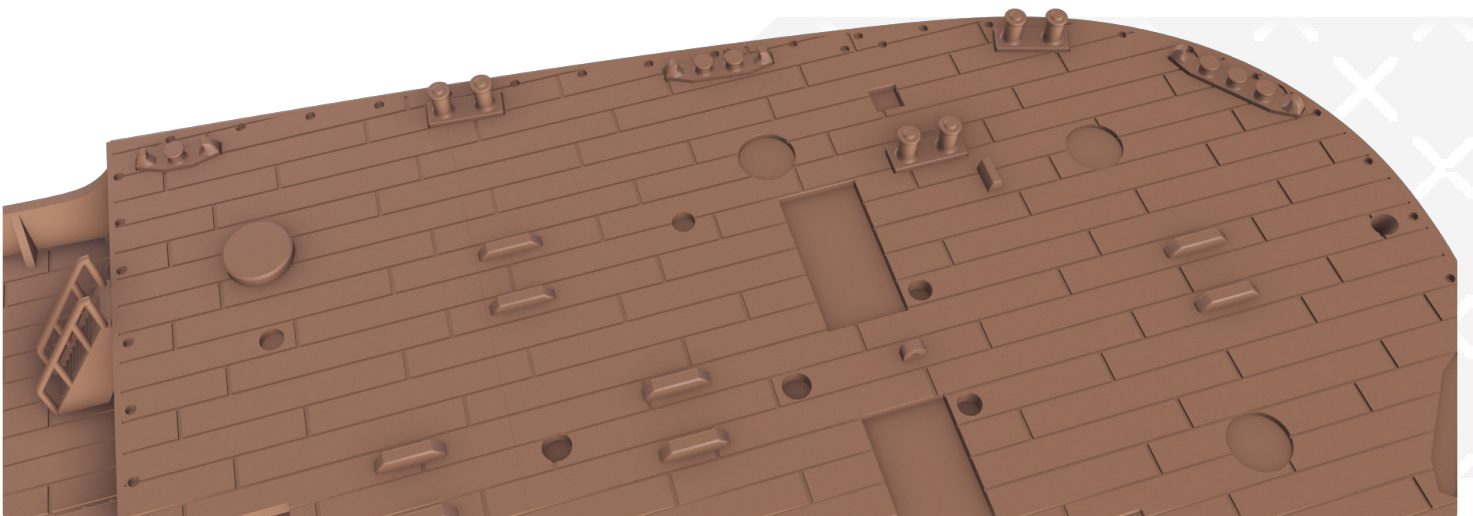
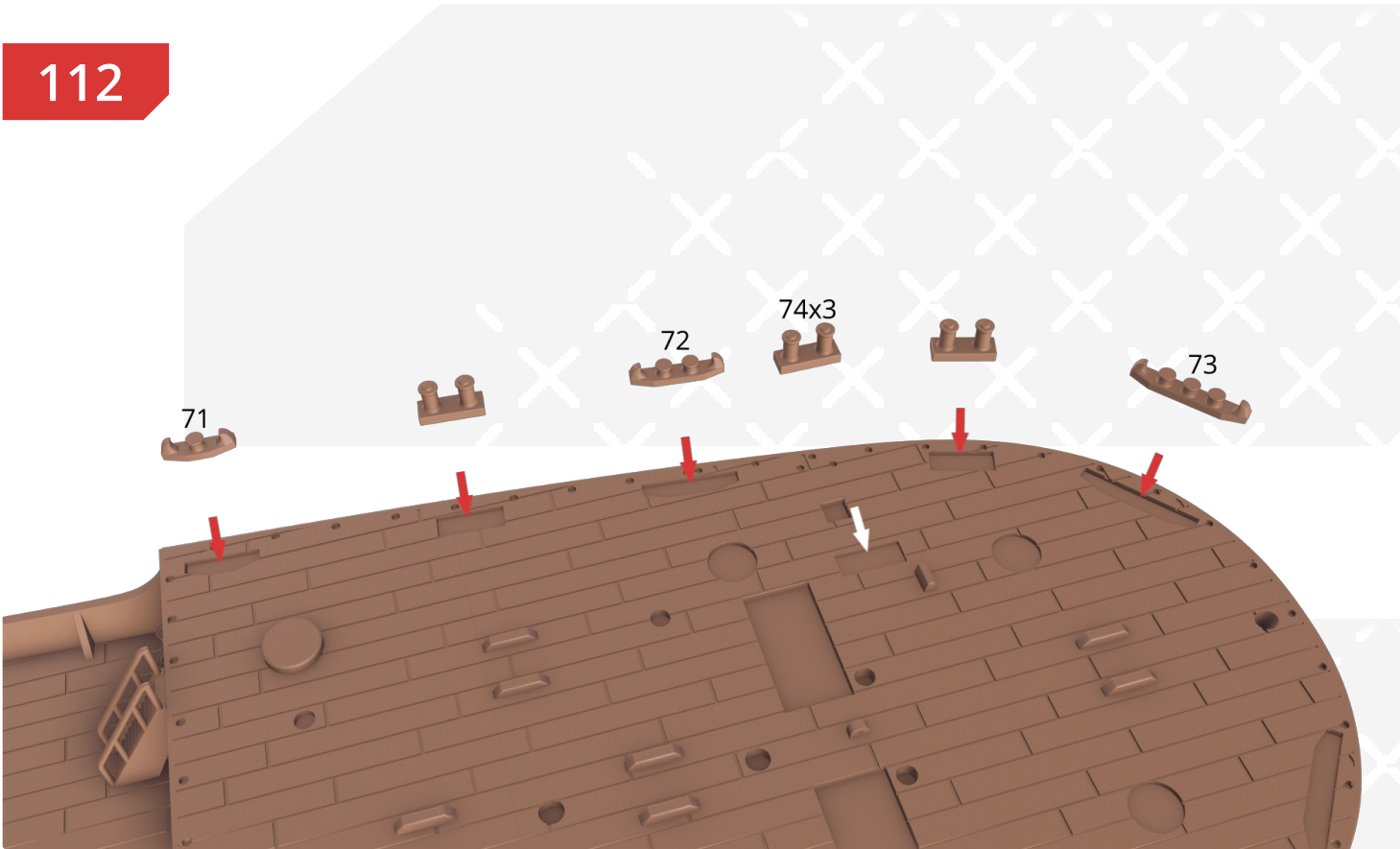

113

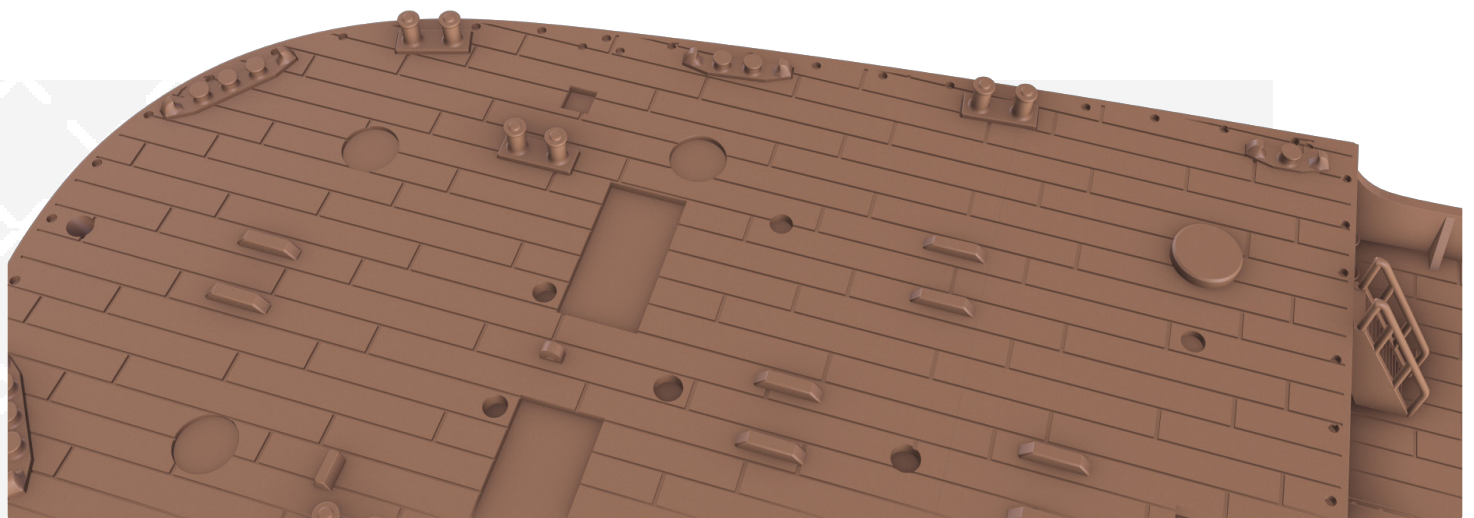
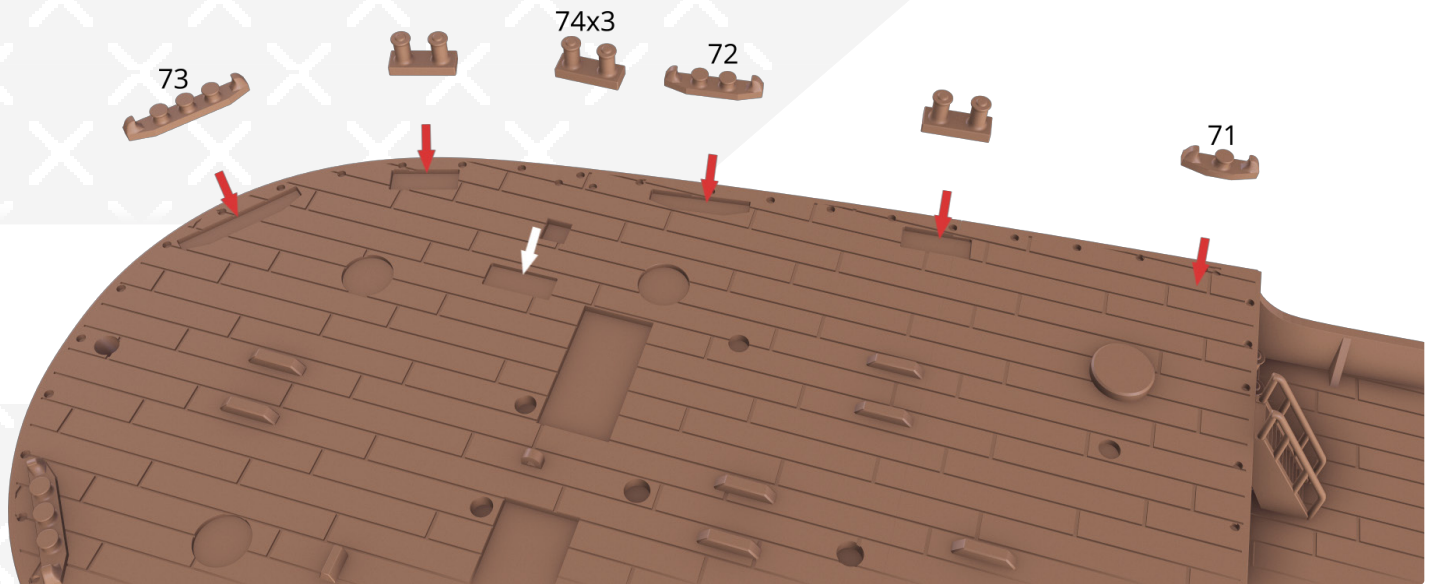

114



115

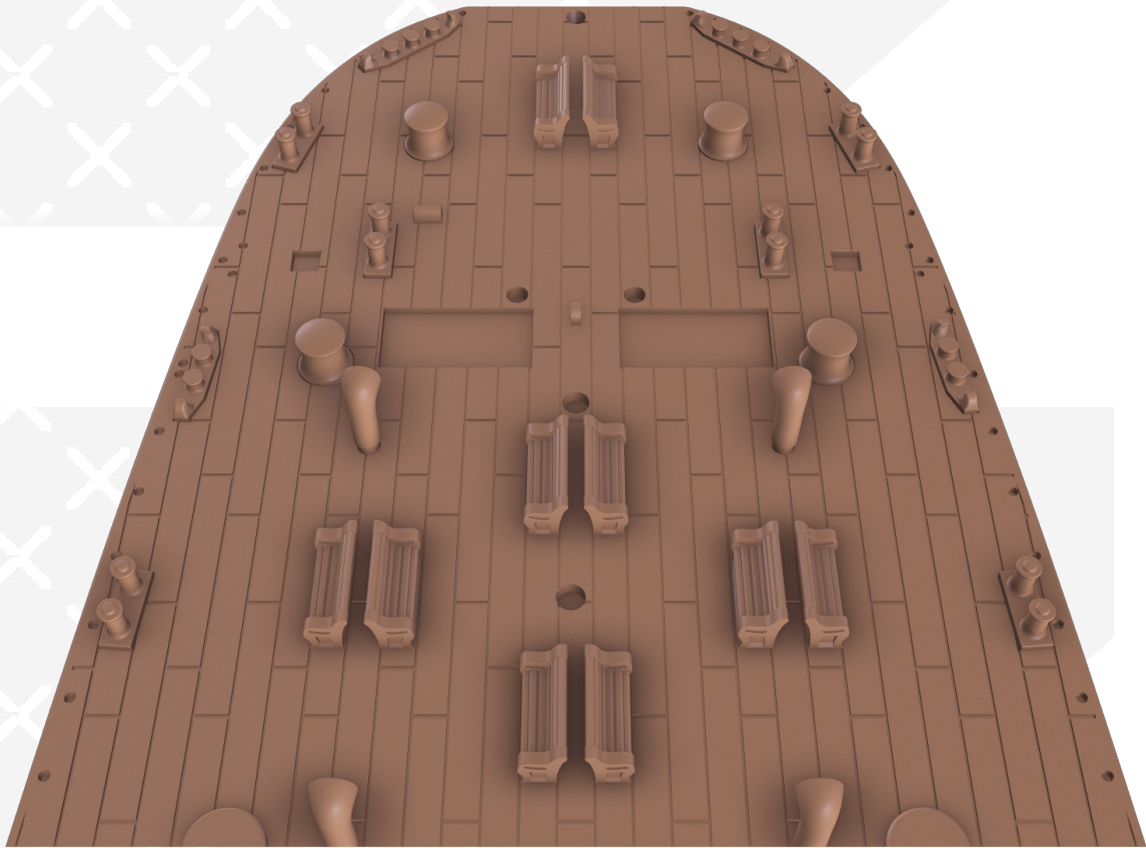
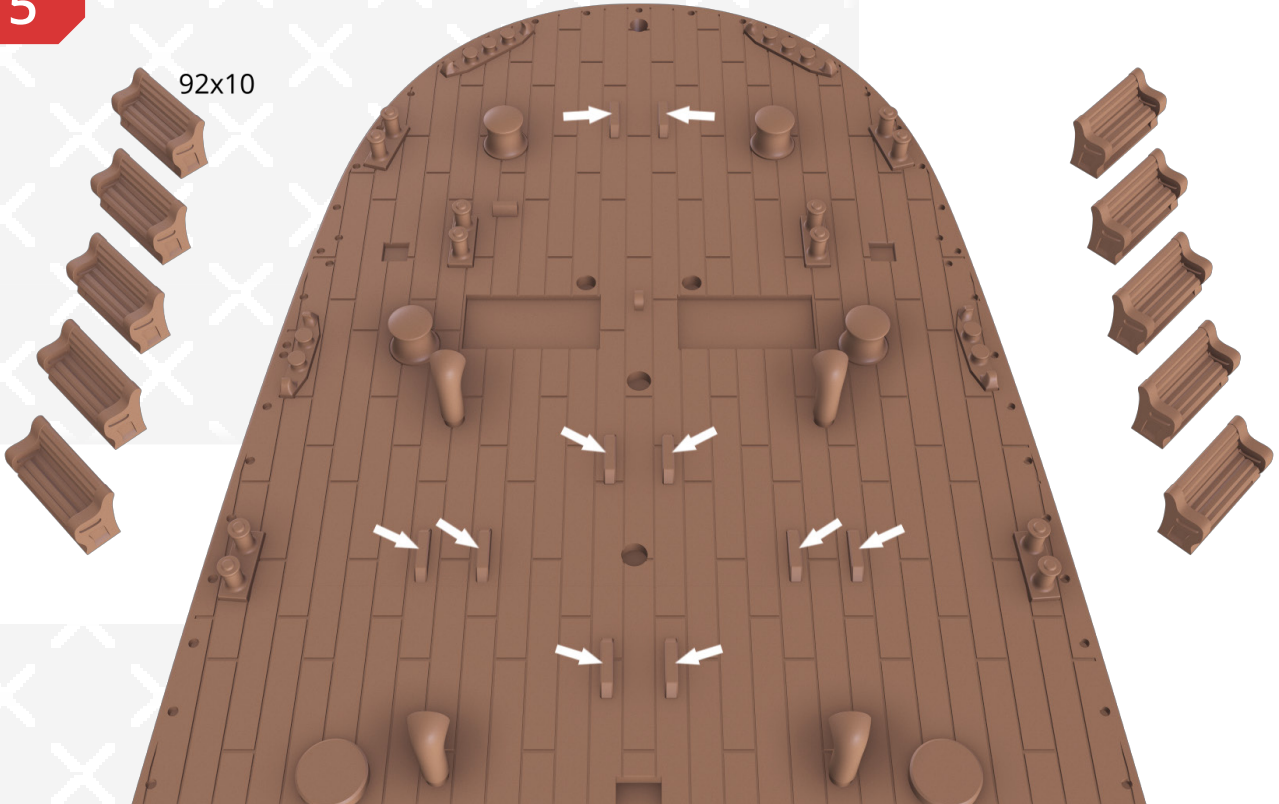

116

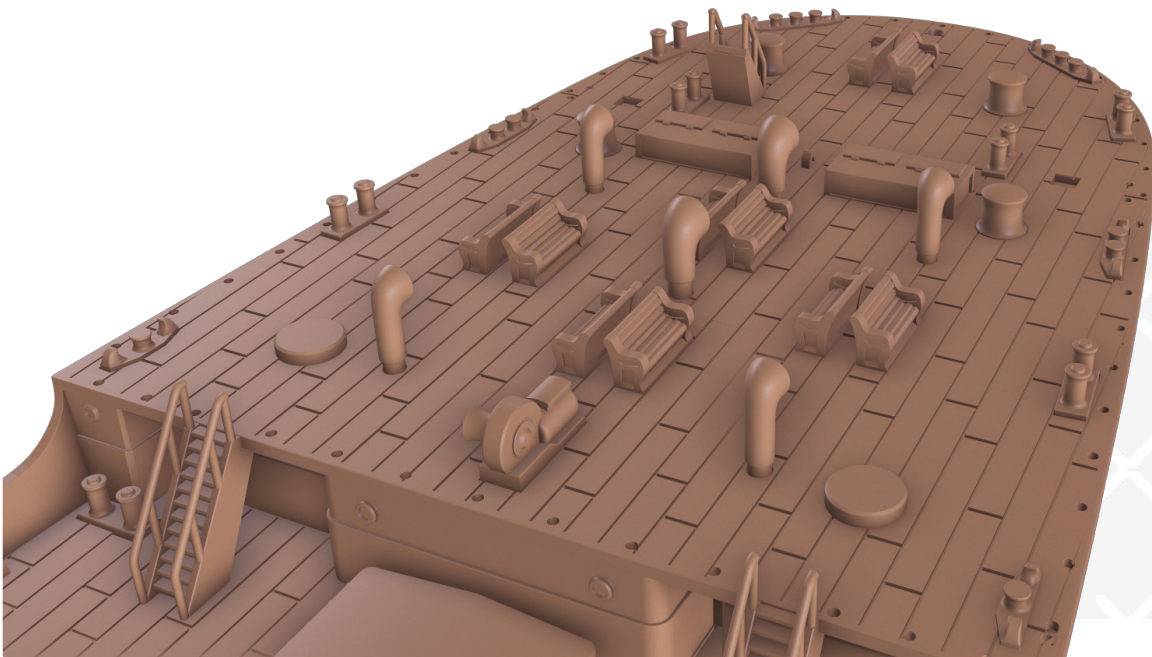

117

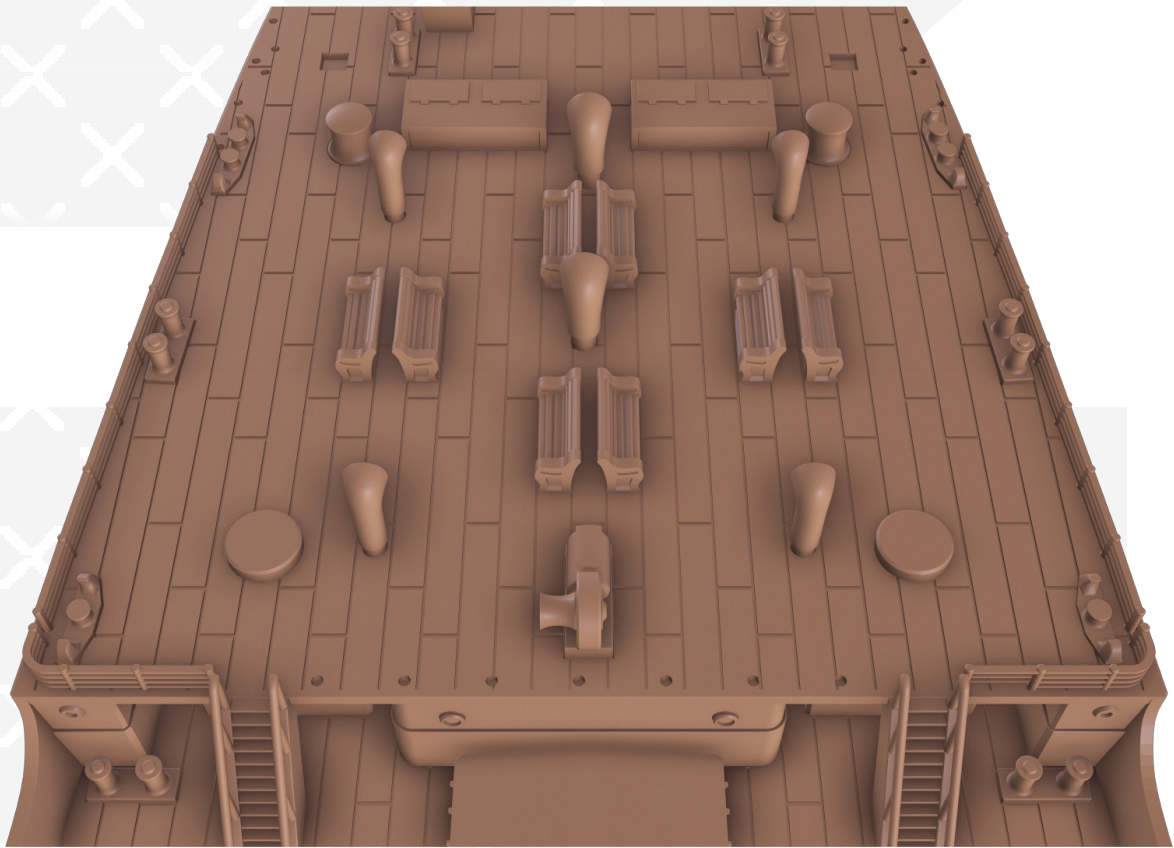
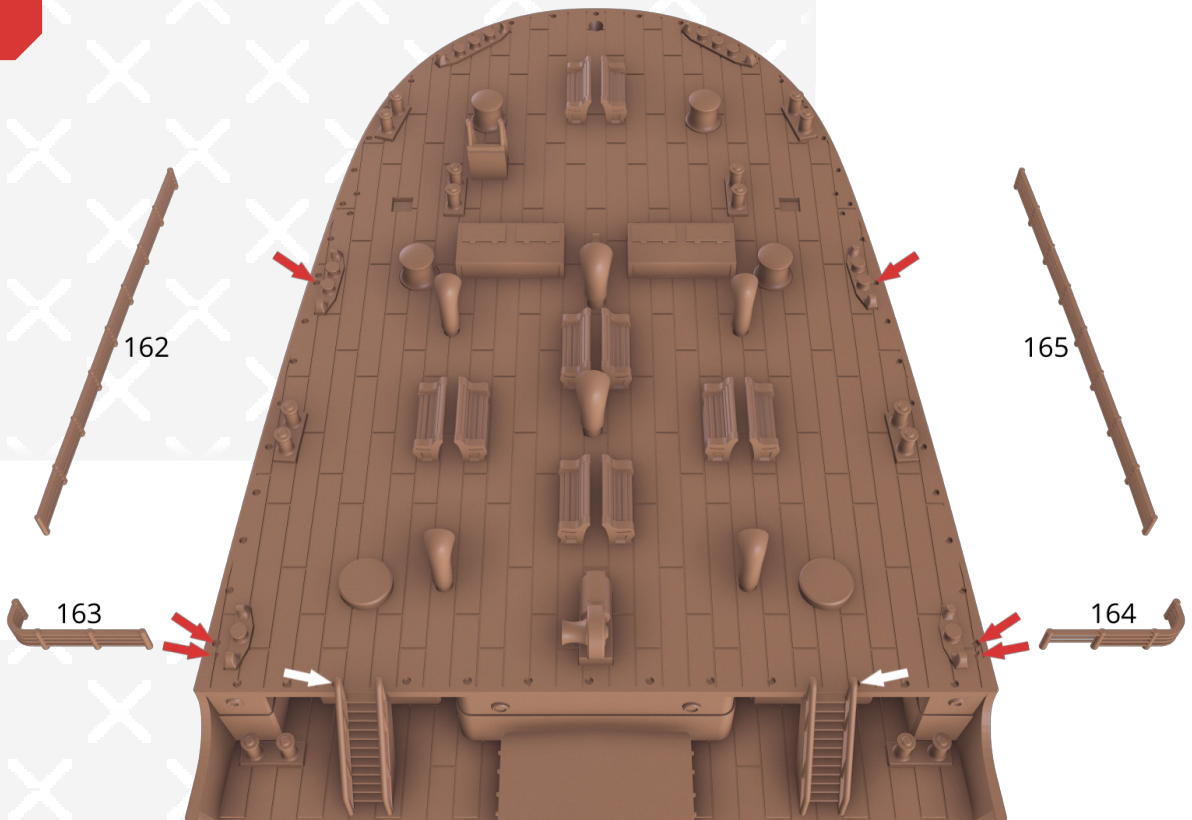

118

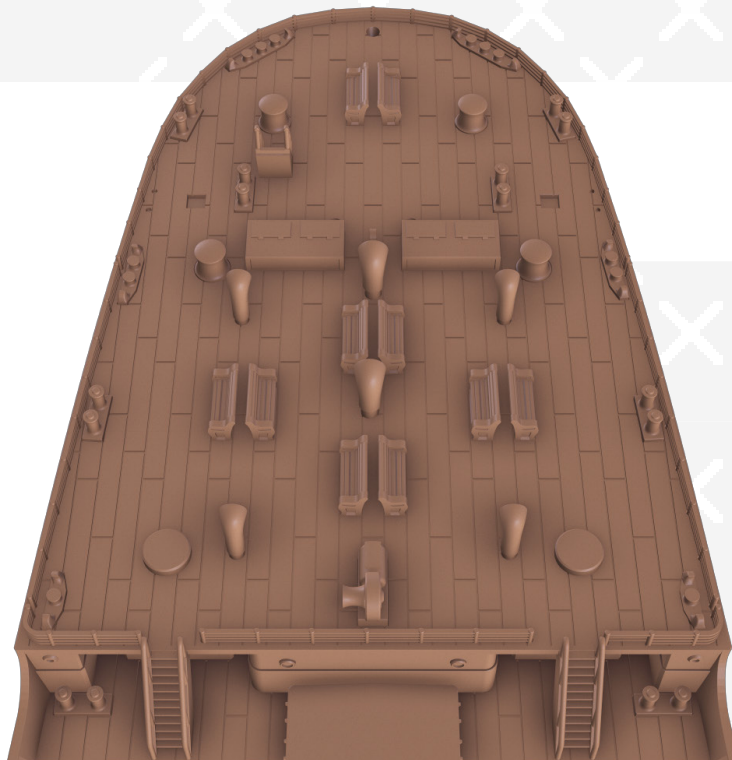
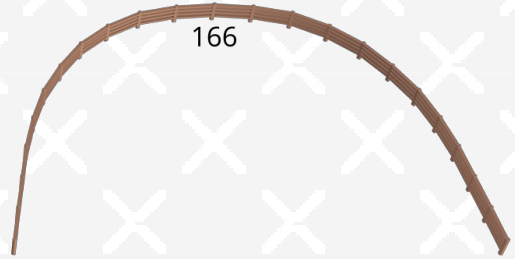
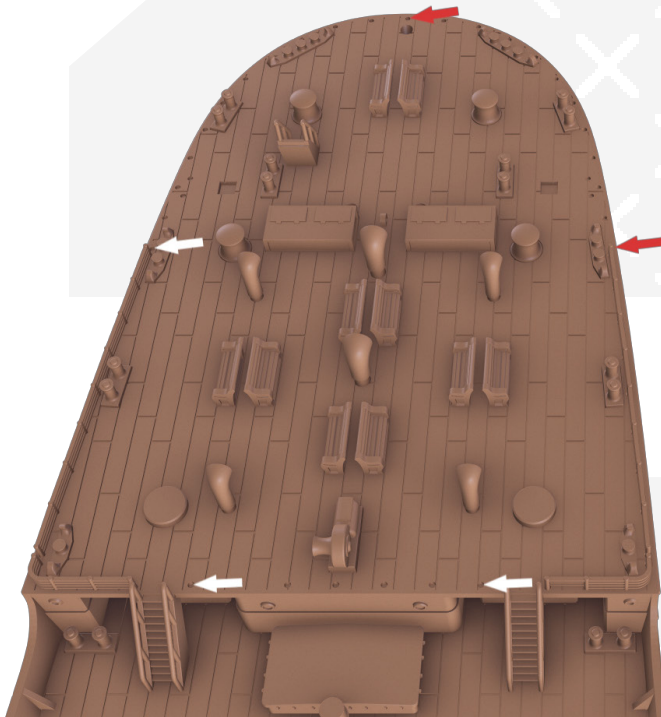

119

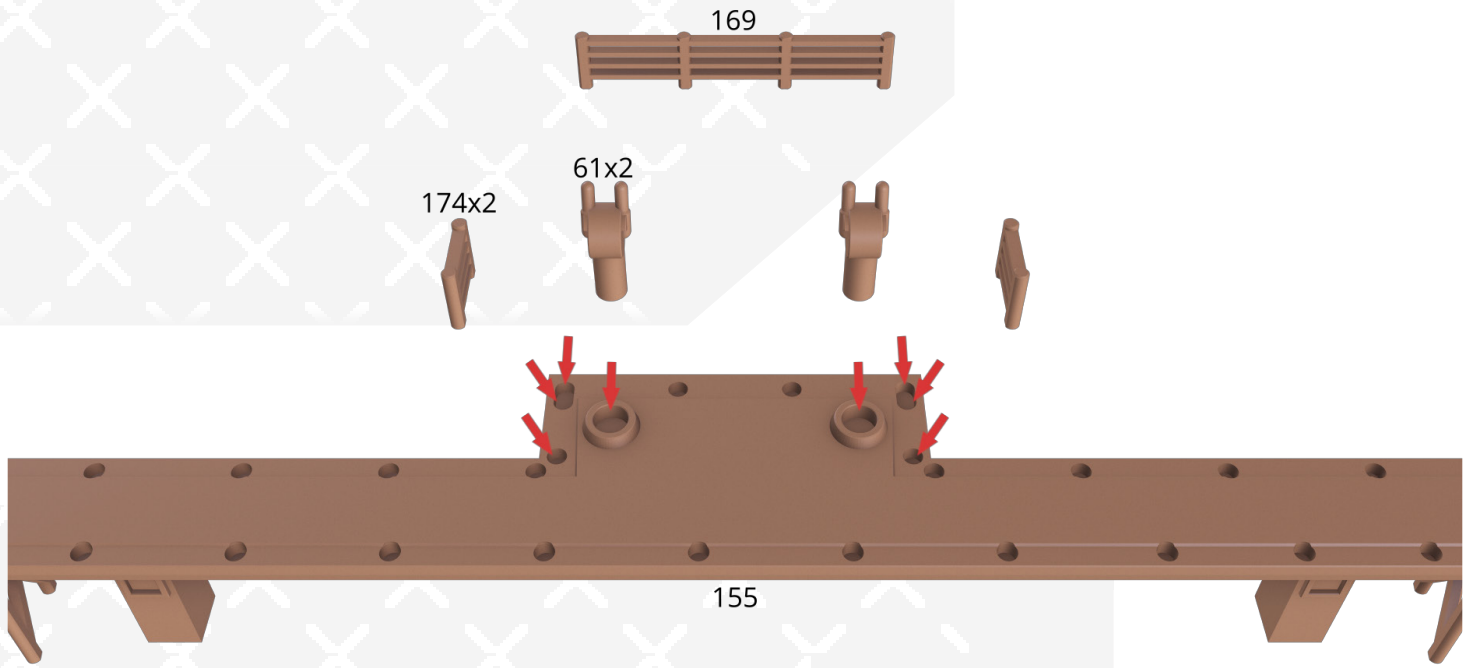

120

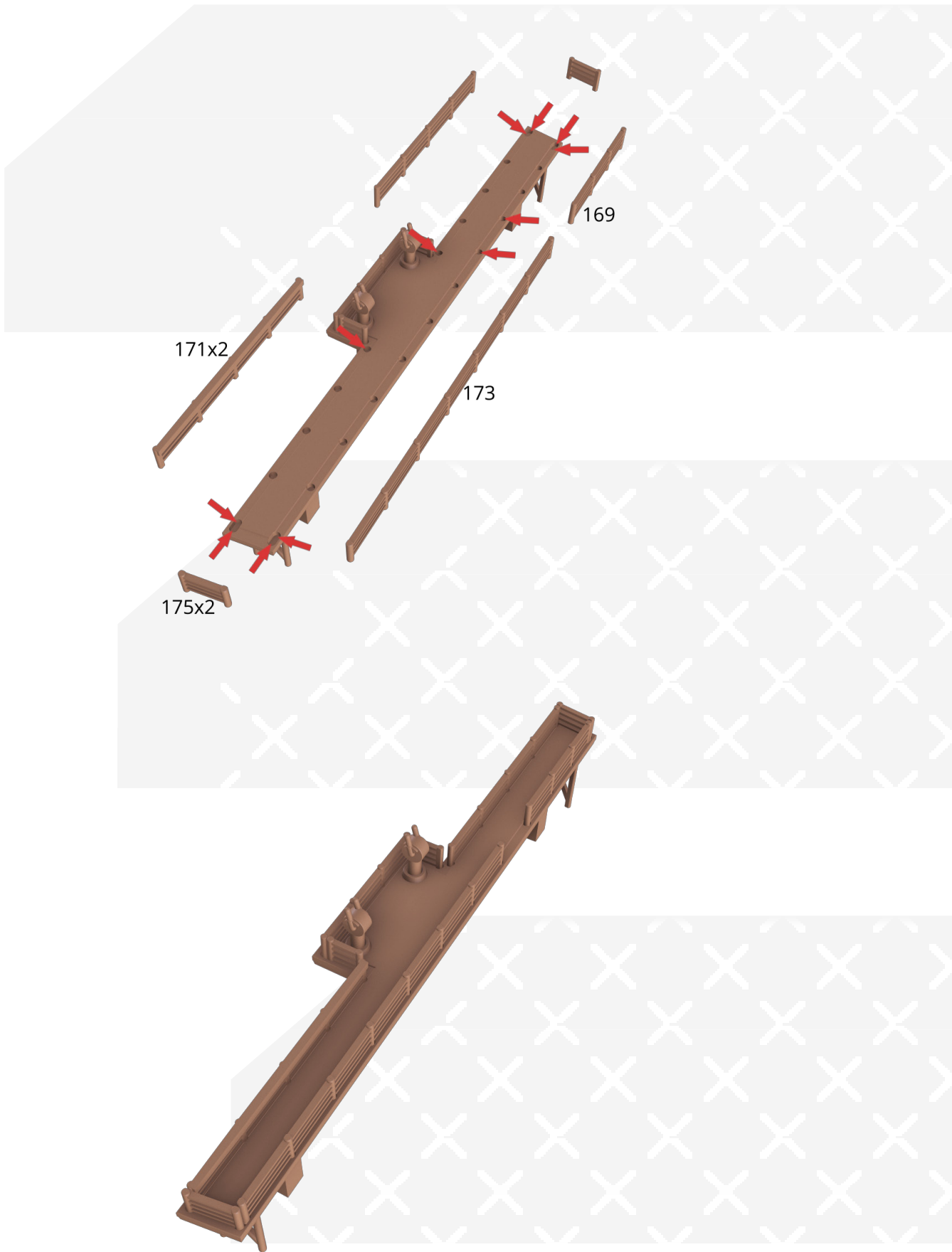

121

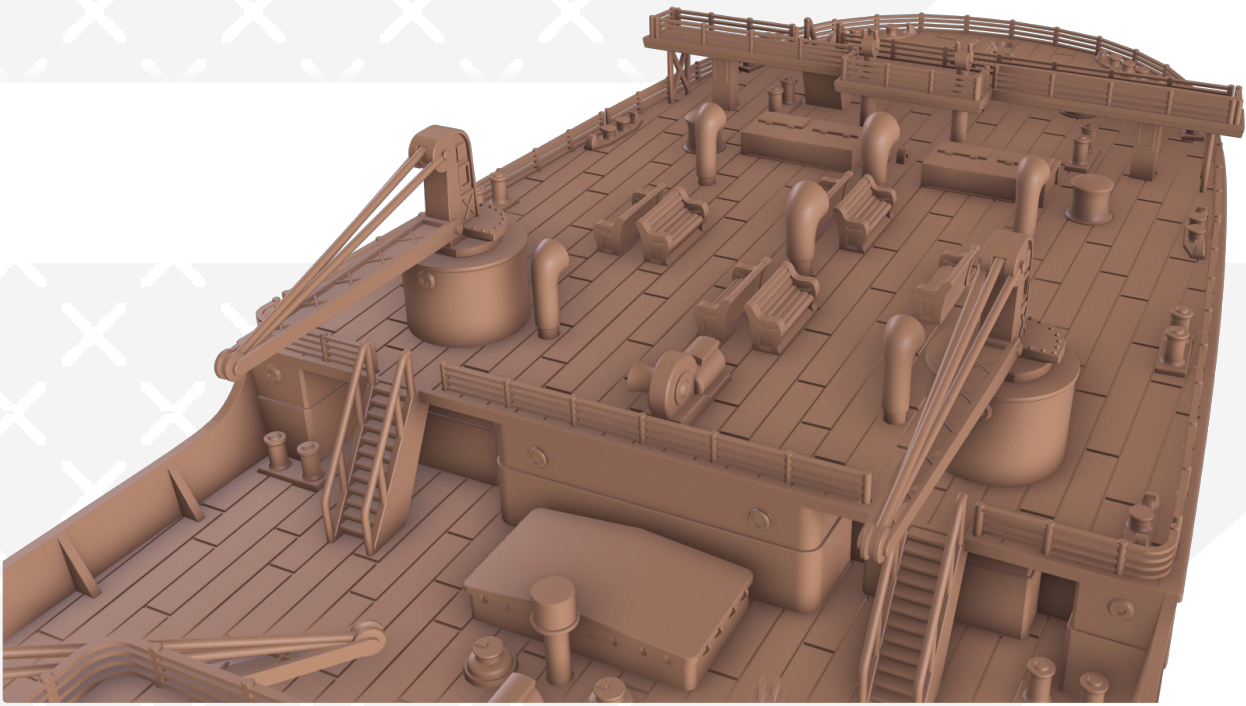
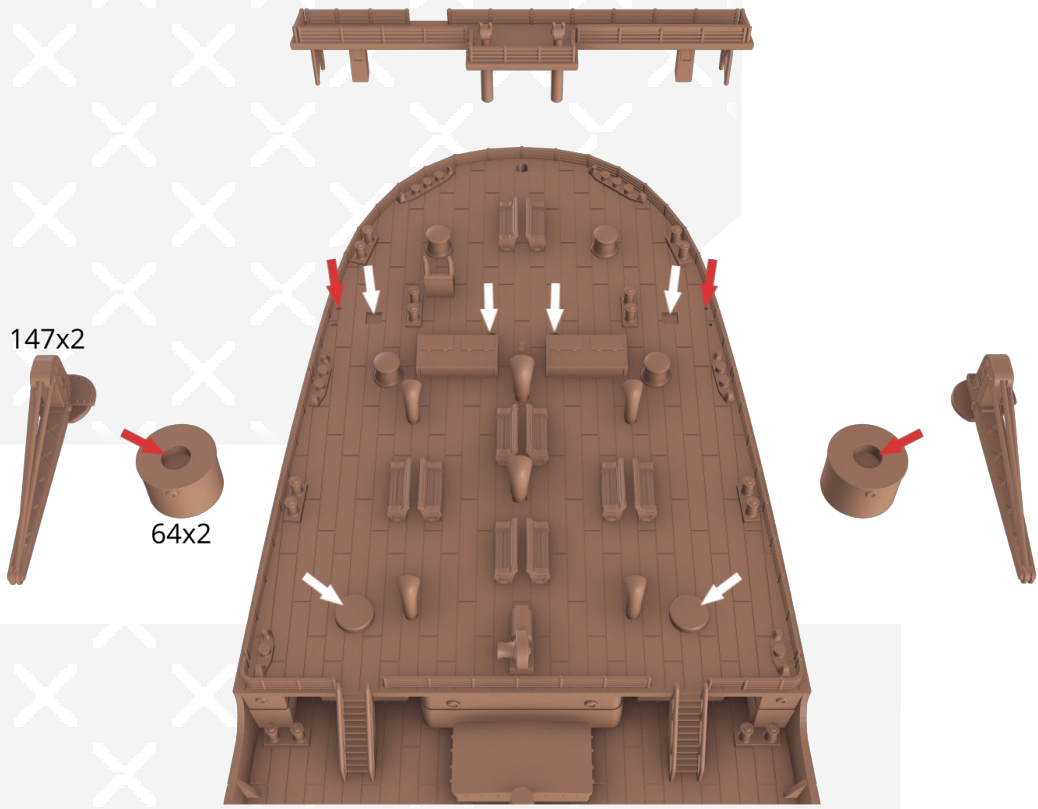

122

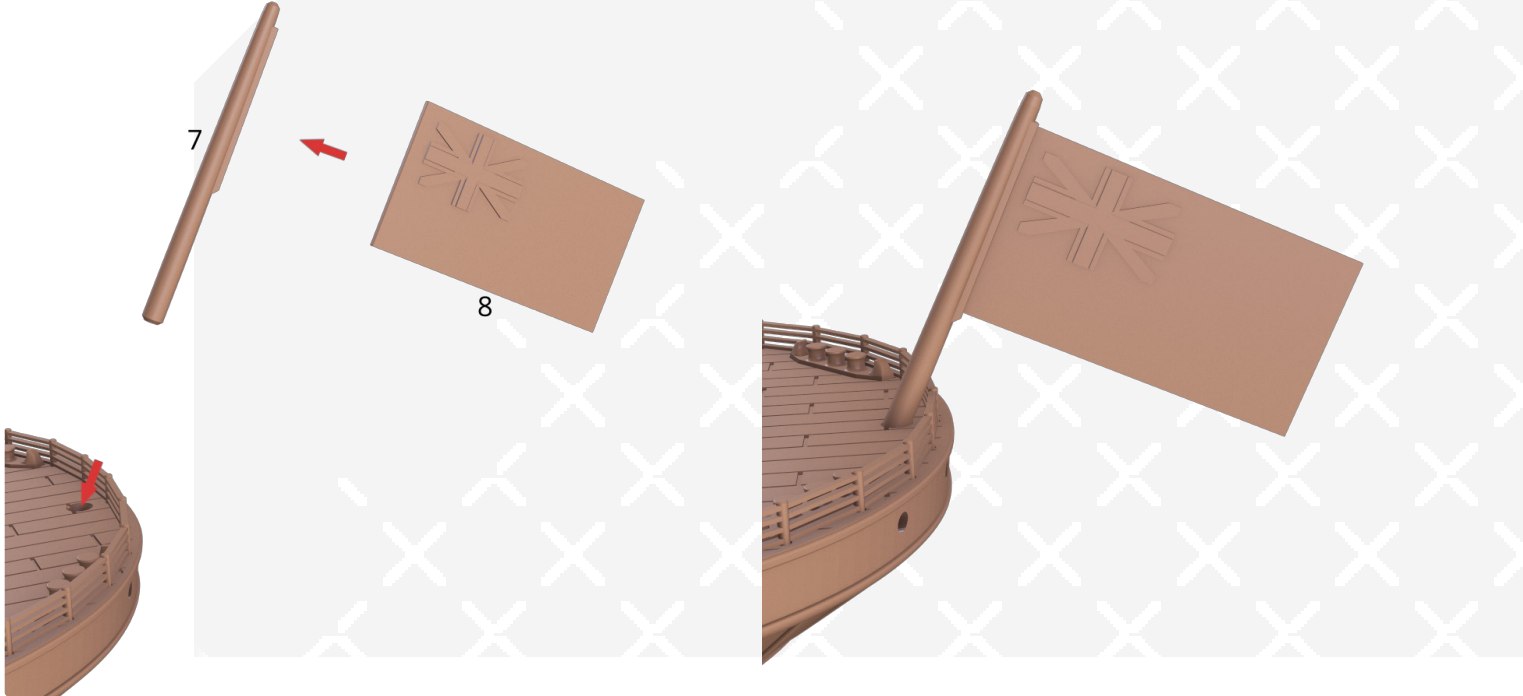

123

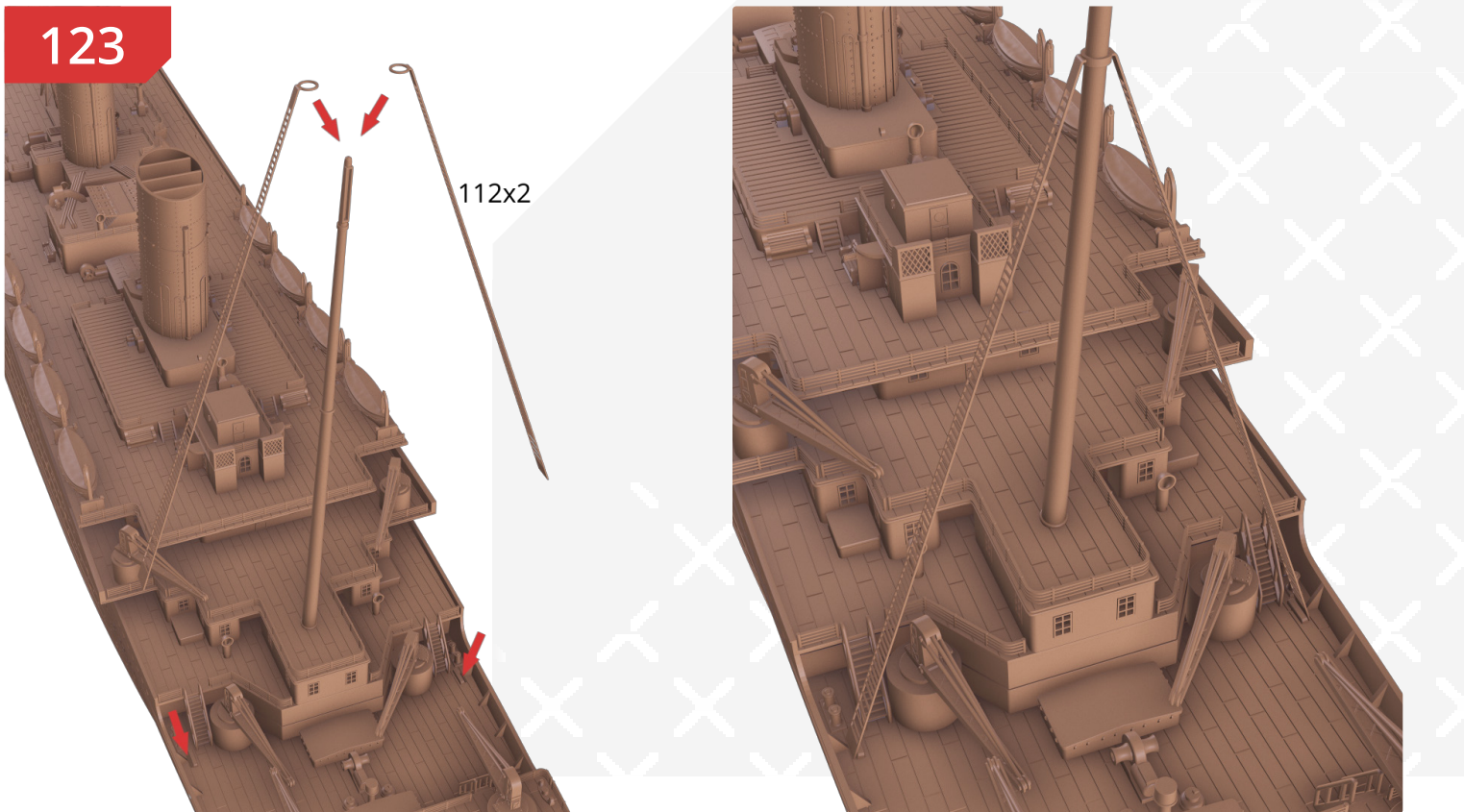

124

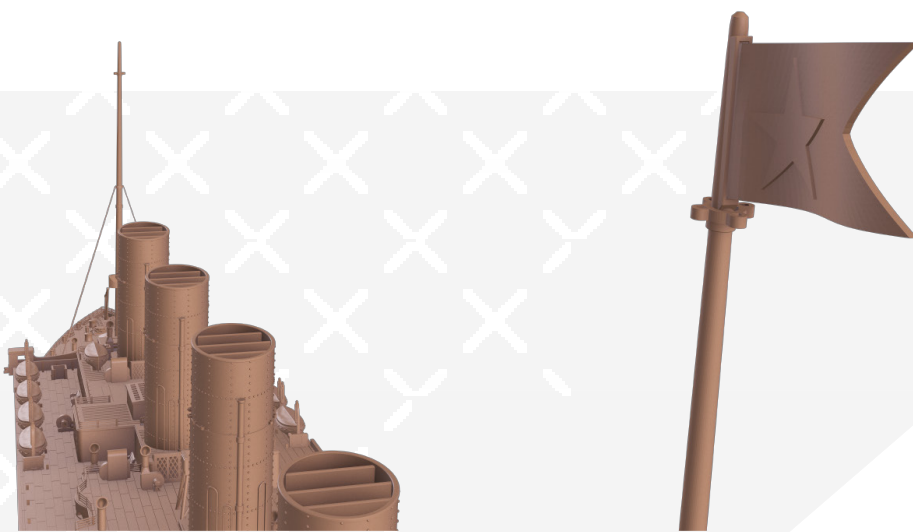
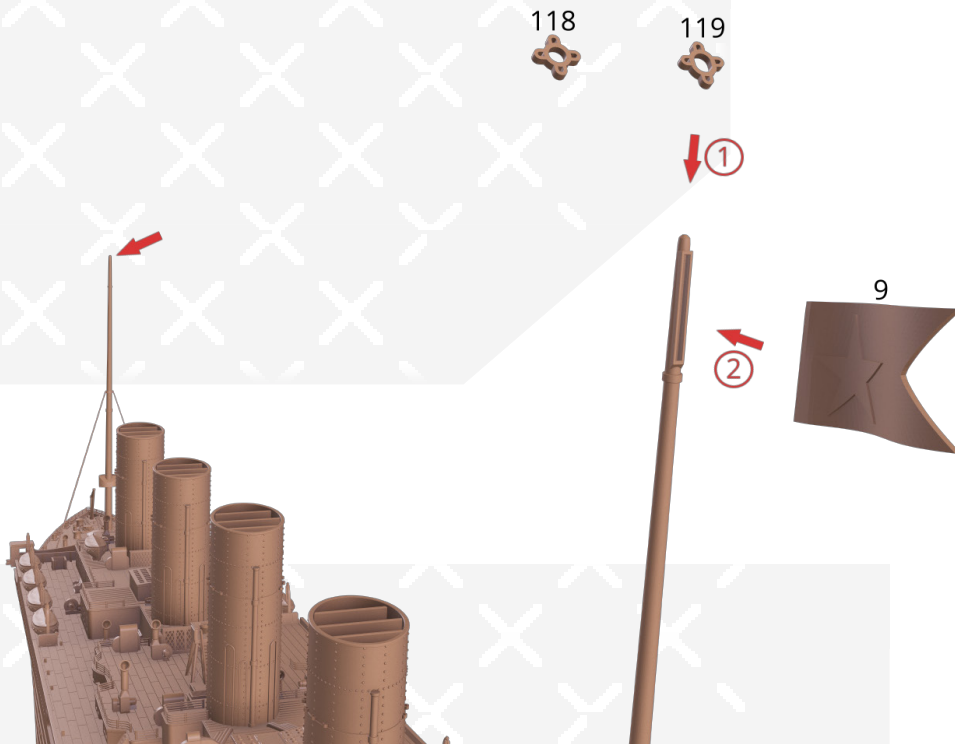

125

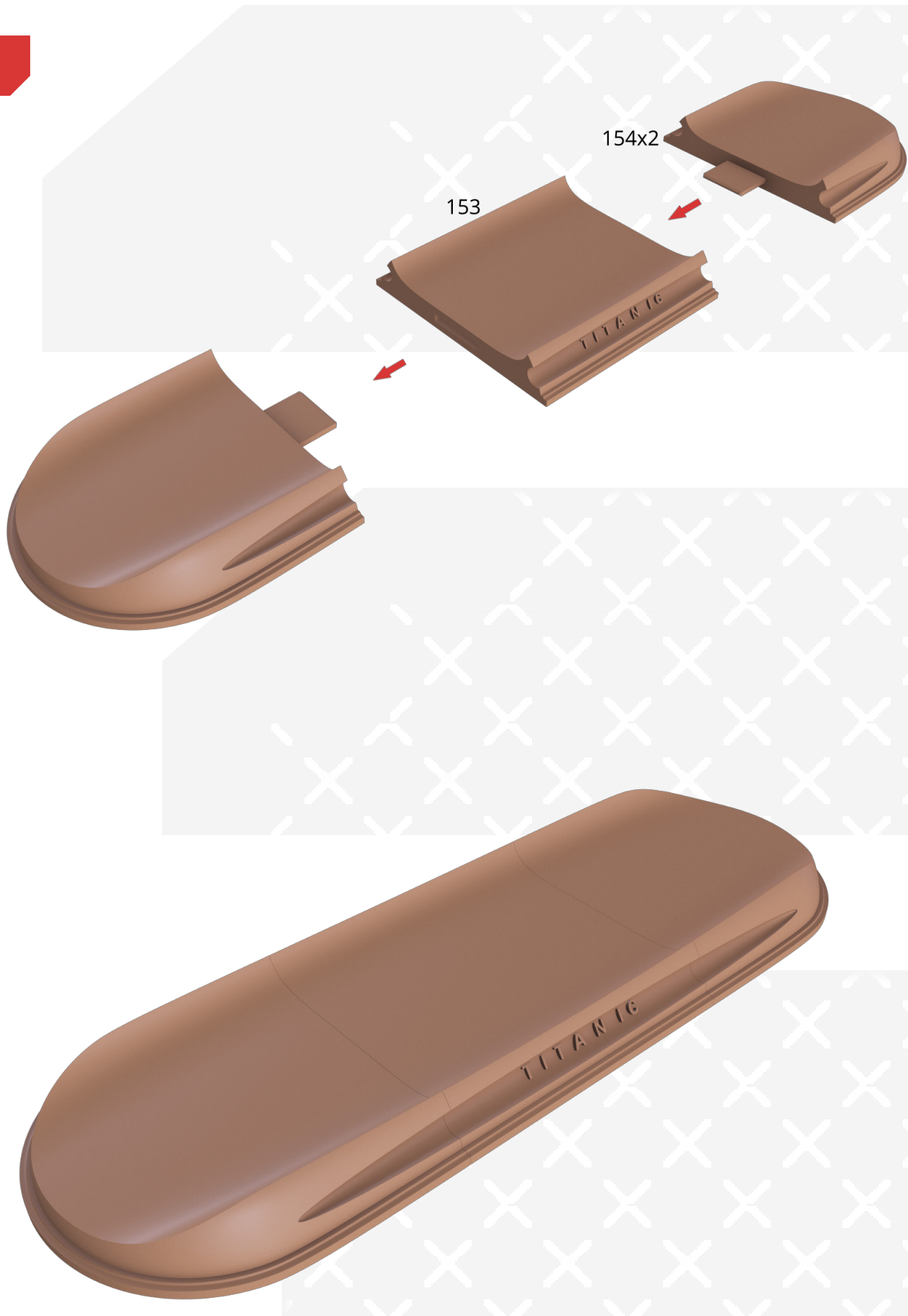

126

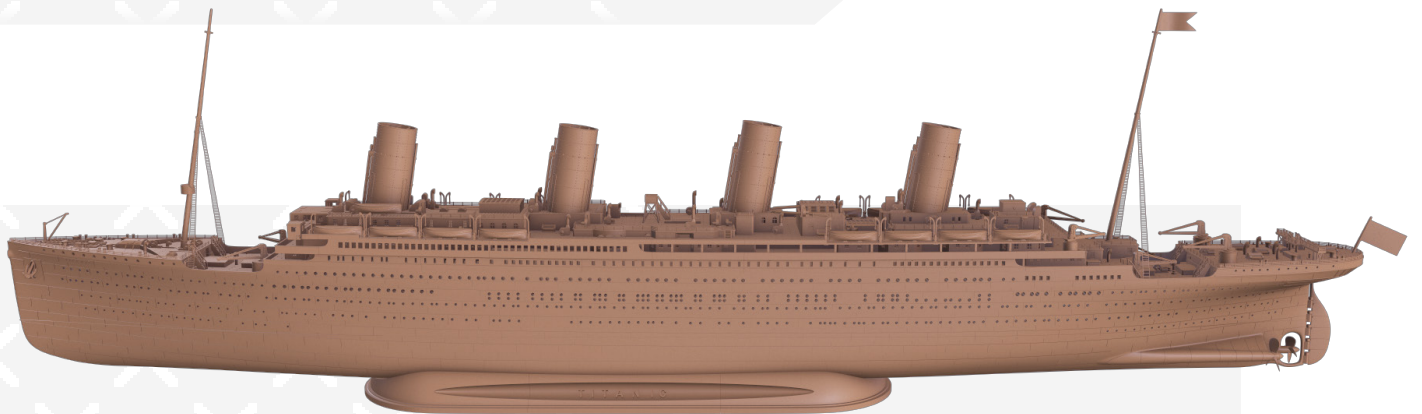
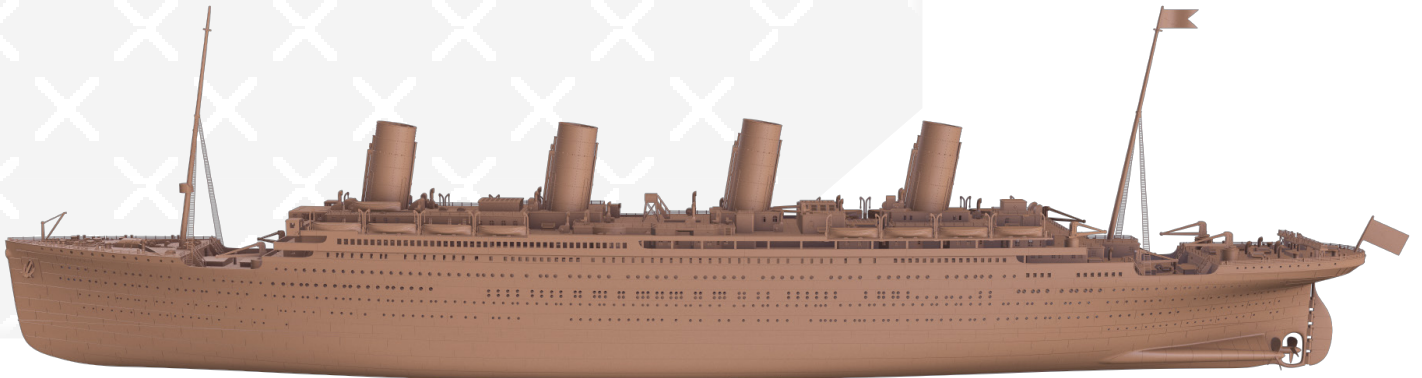

127

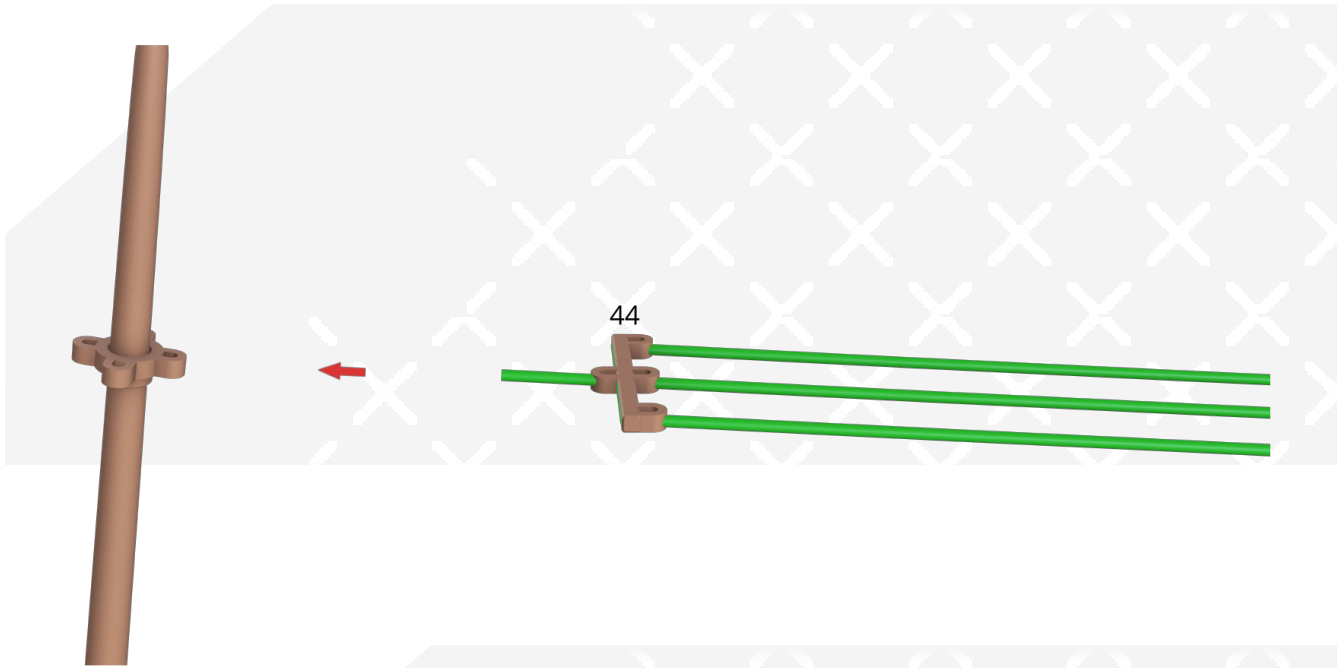

The green parts are ropes that are not included in the assembly but can be added later on.

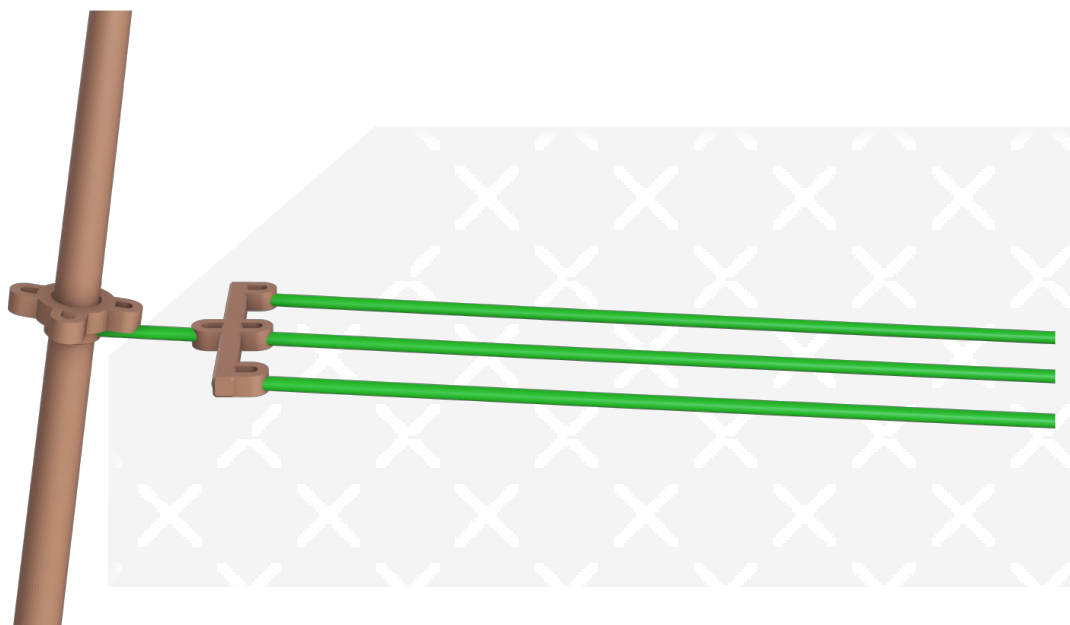

128



The green parts are ropes that are not included in the assembly but can be added later on.

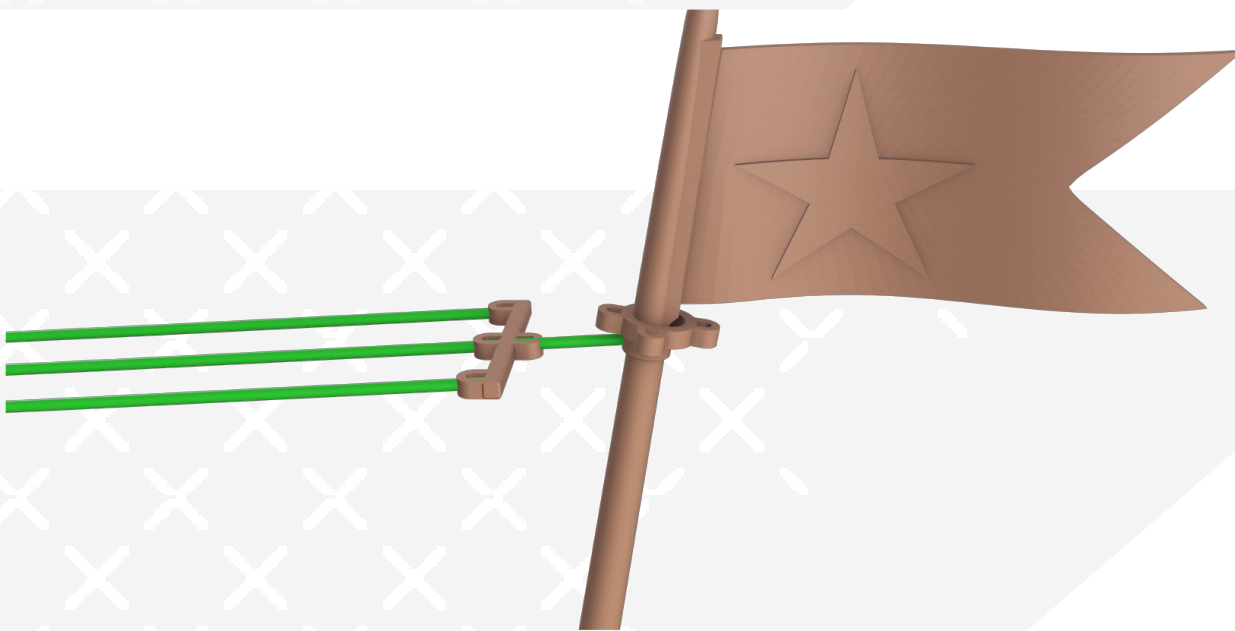

129

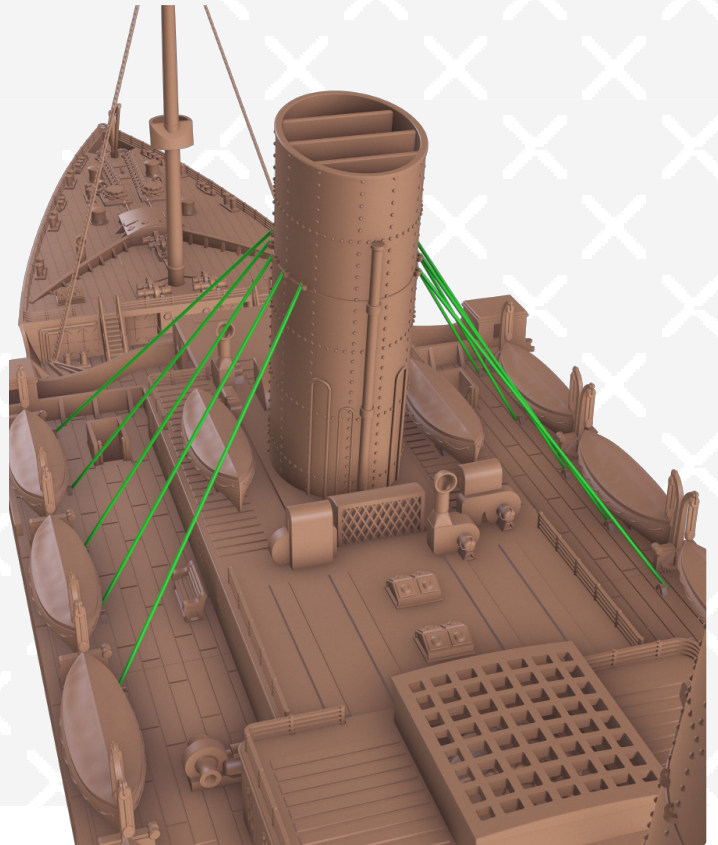
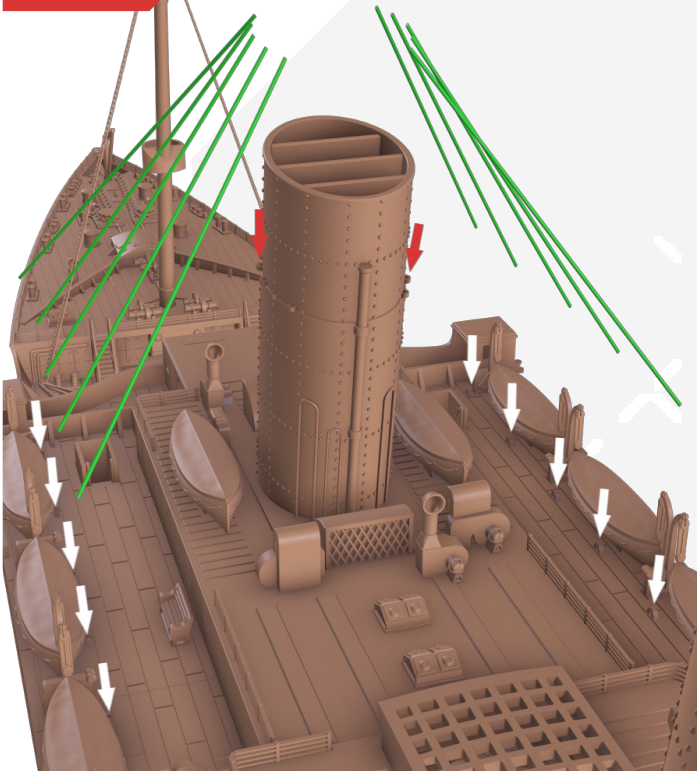

130

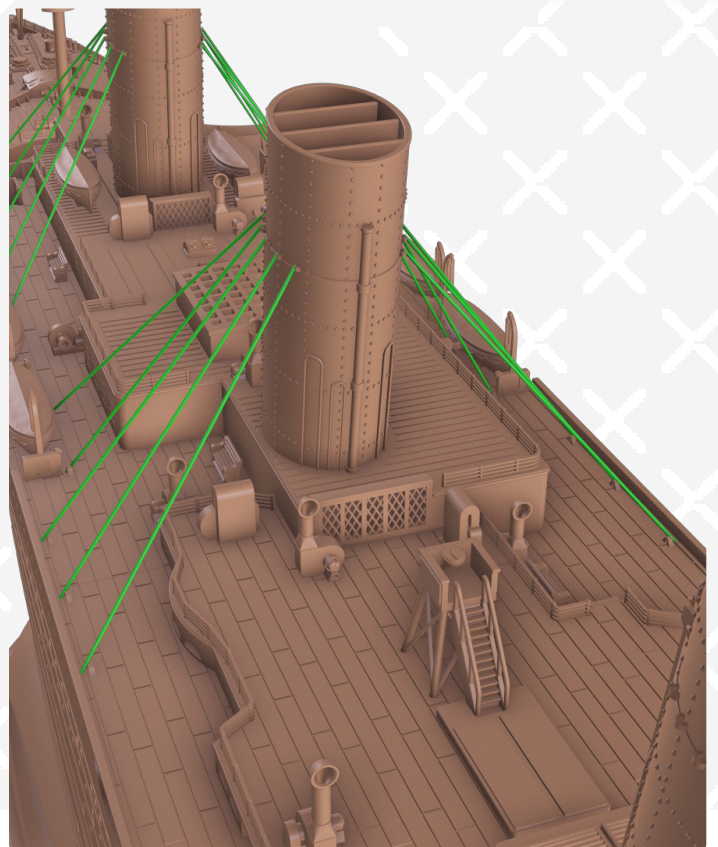
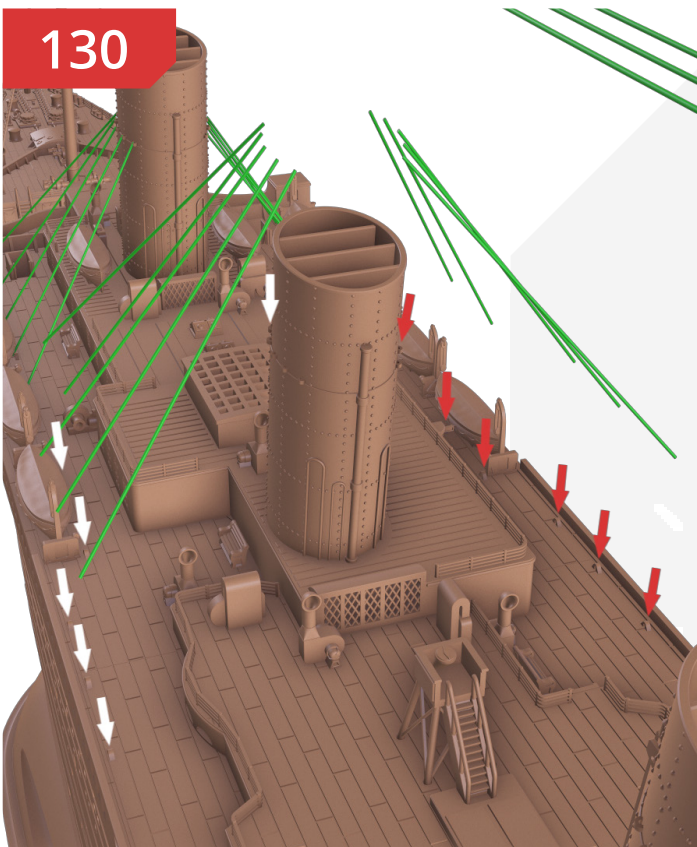

131

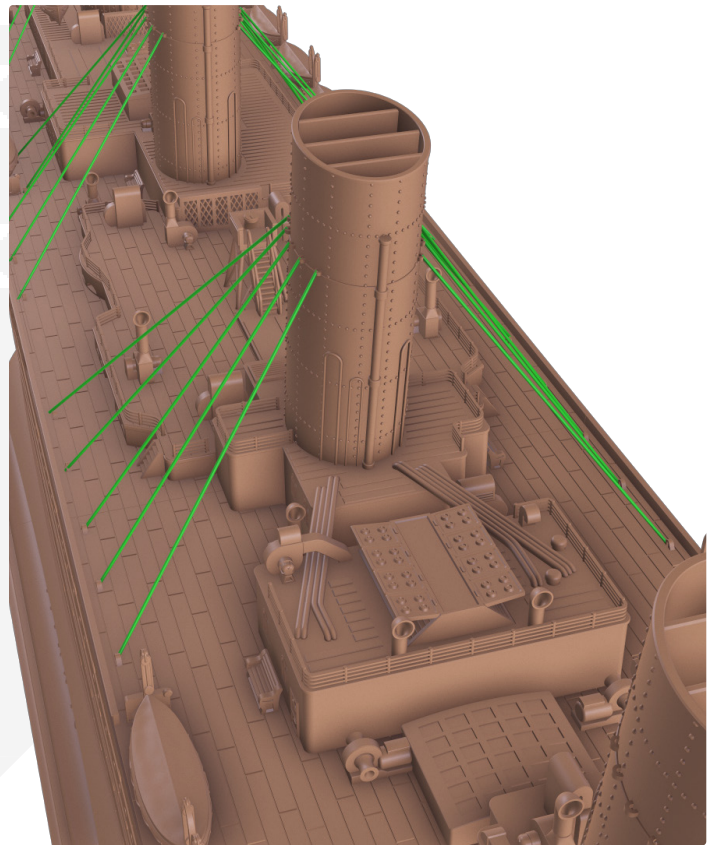
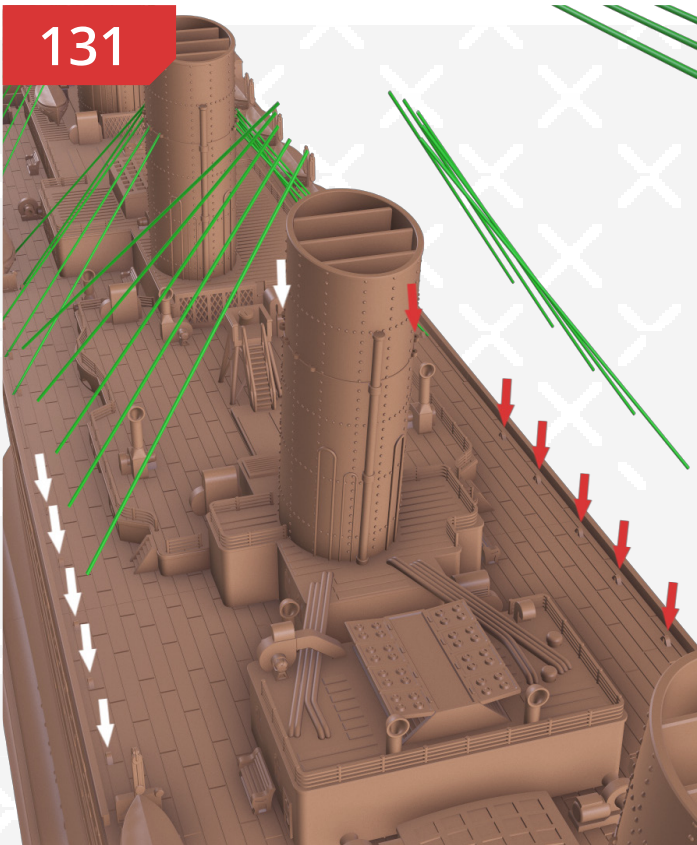

132

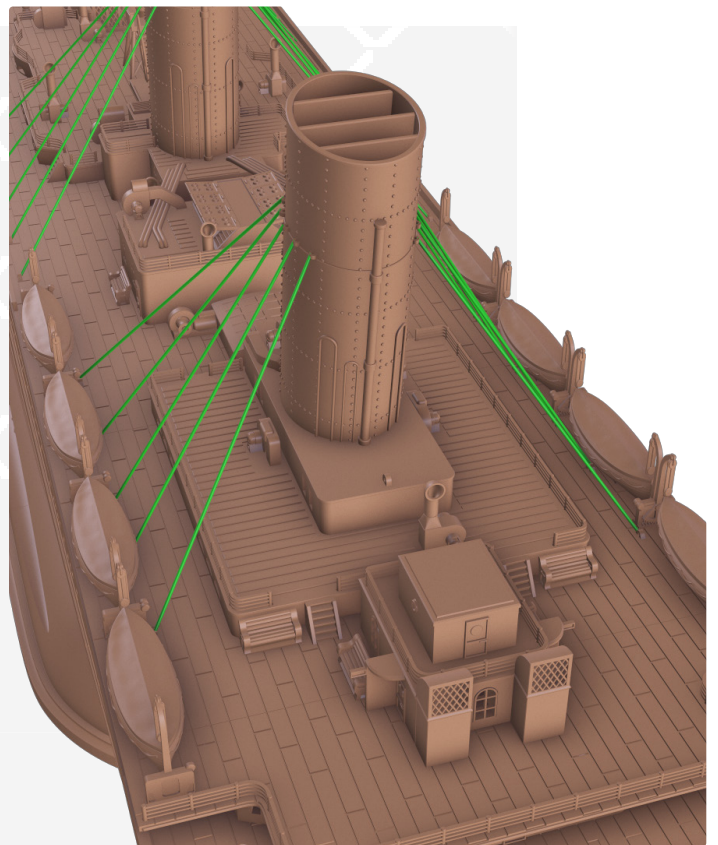
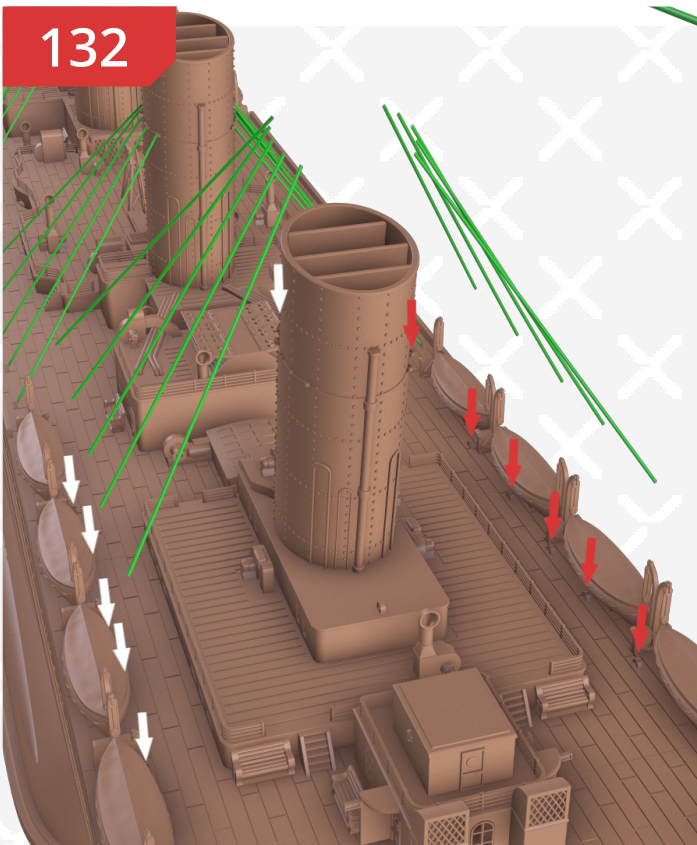

133

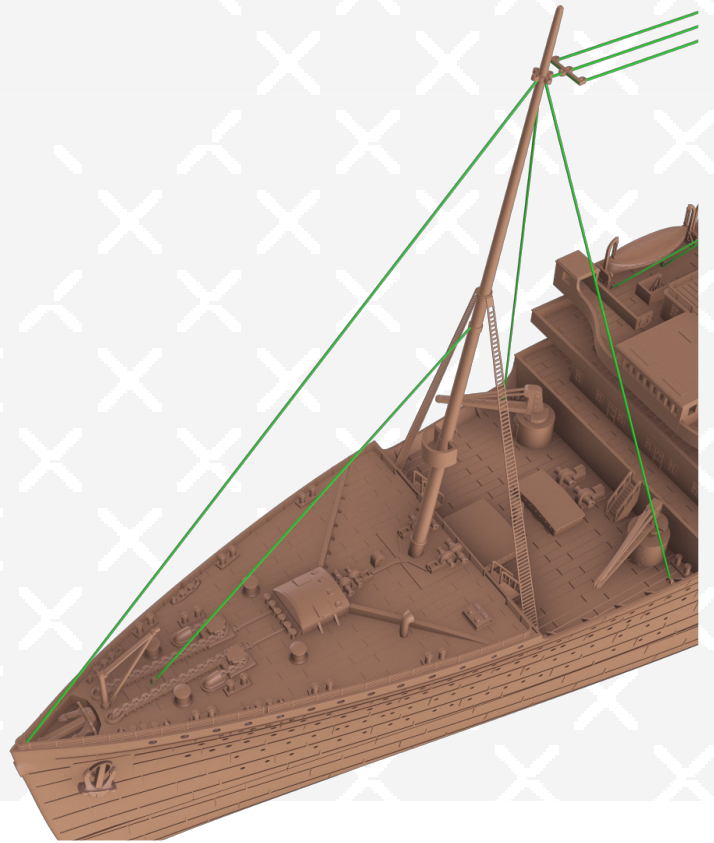
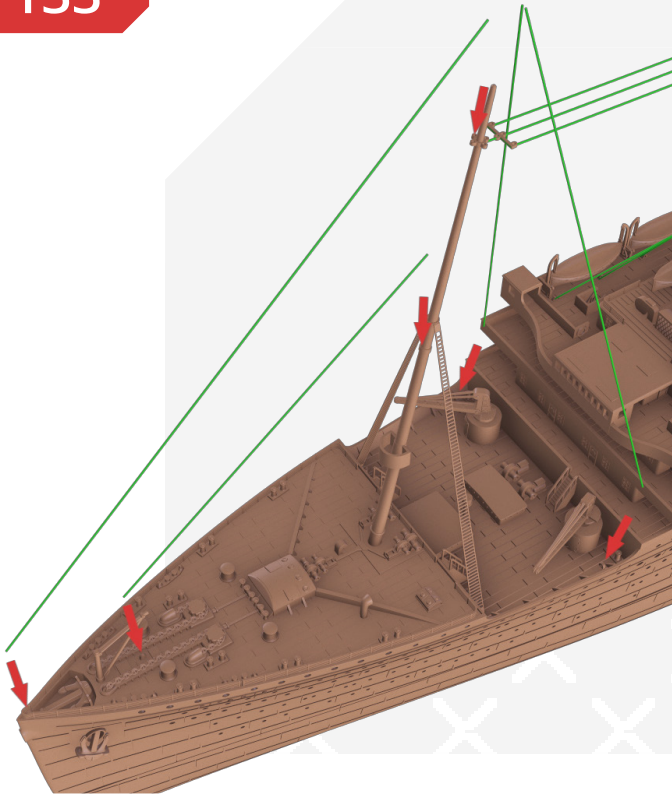

134

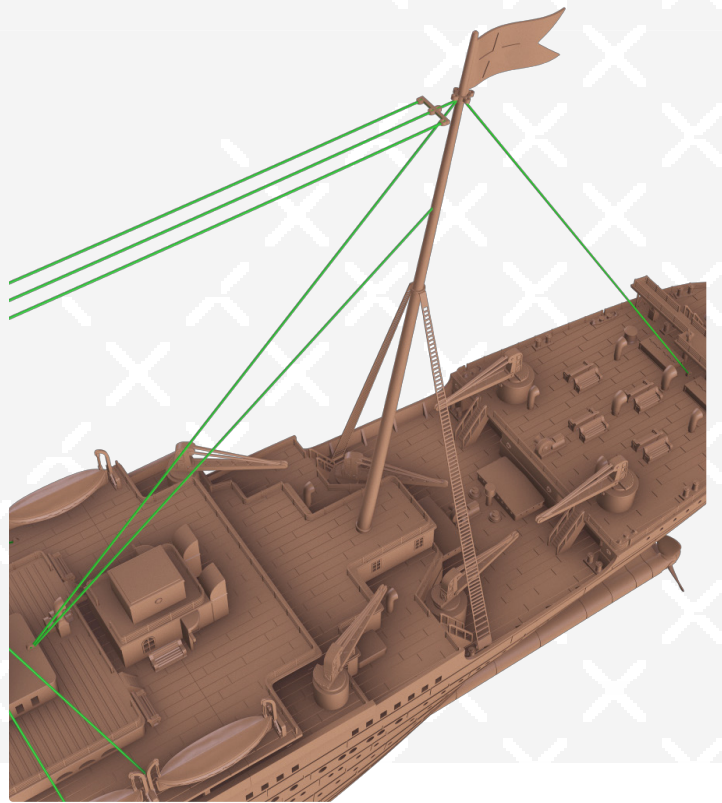
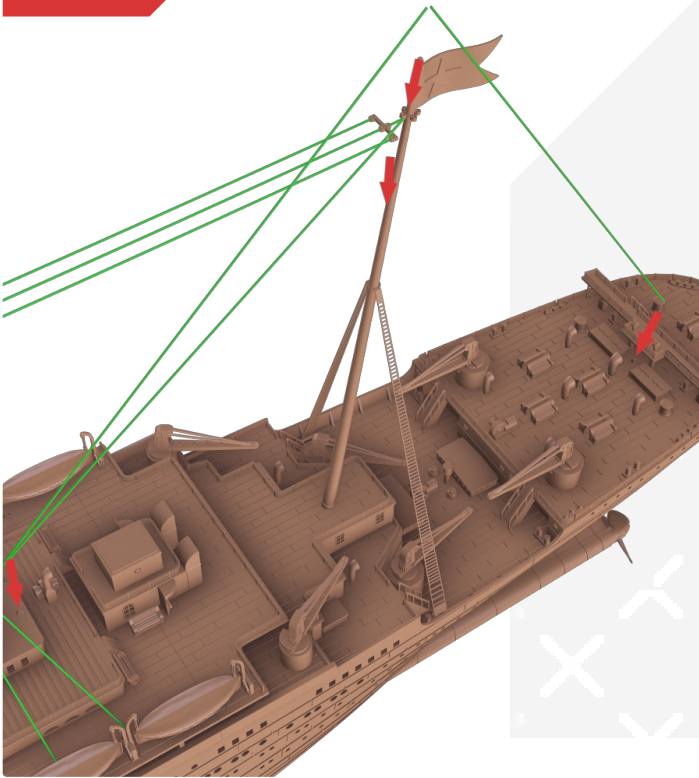

STL files of all 3D printing models come with **full technical support** from **Gam**body team for life. If you have any questions or if you want to have any changes introduced, please, write to us at support@gambody.com.

Thank you for choosing
Gambody!

