



Stargate

3D printing model

Assembly manual  
for FFF/FDM

Copyright

1



2 variants of the ring: solid and comprised of 3 parts.

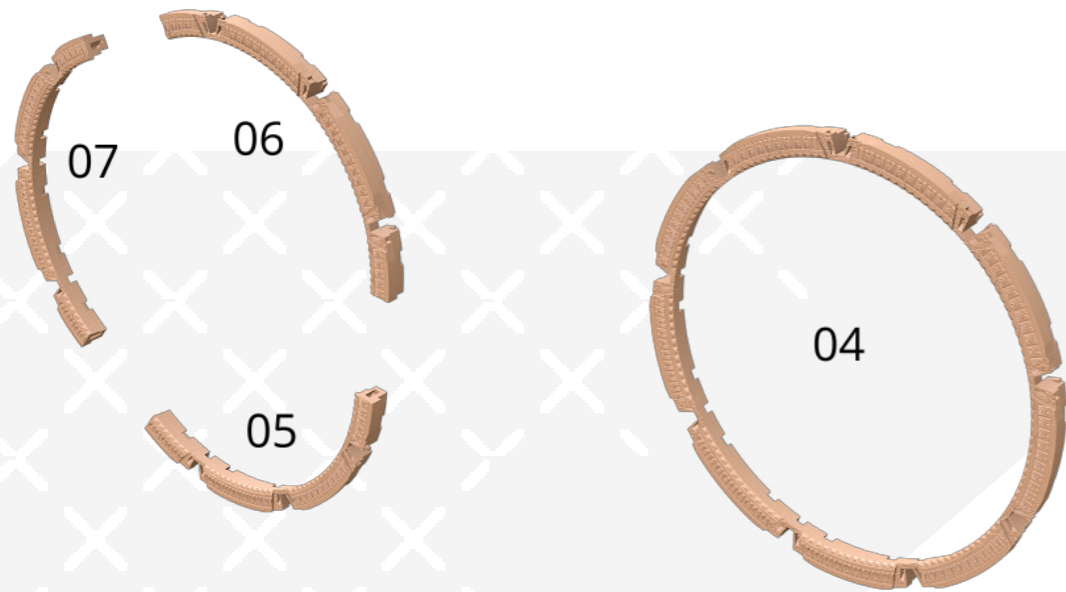

2

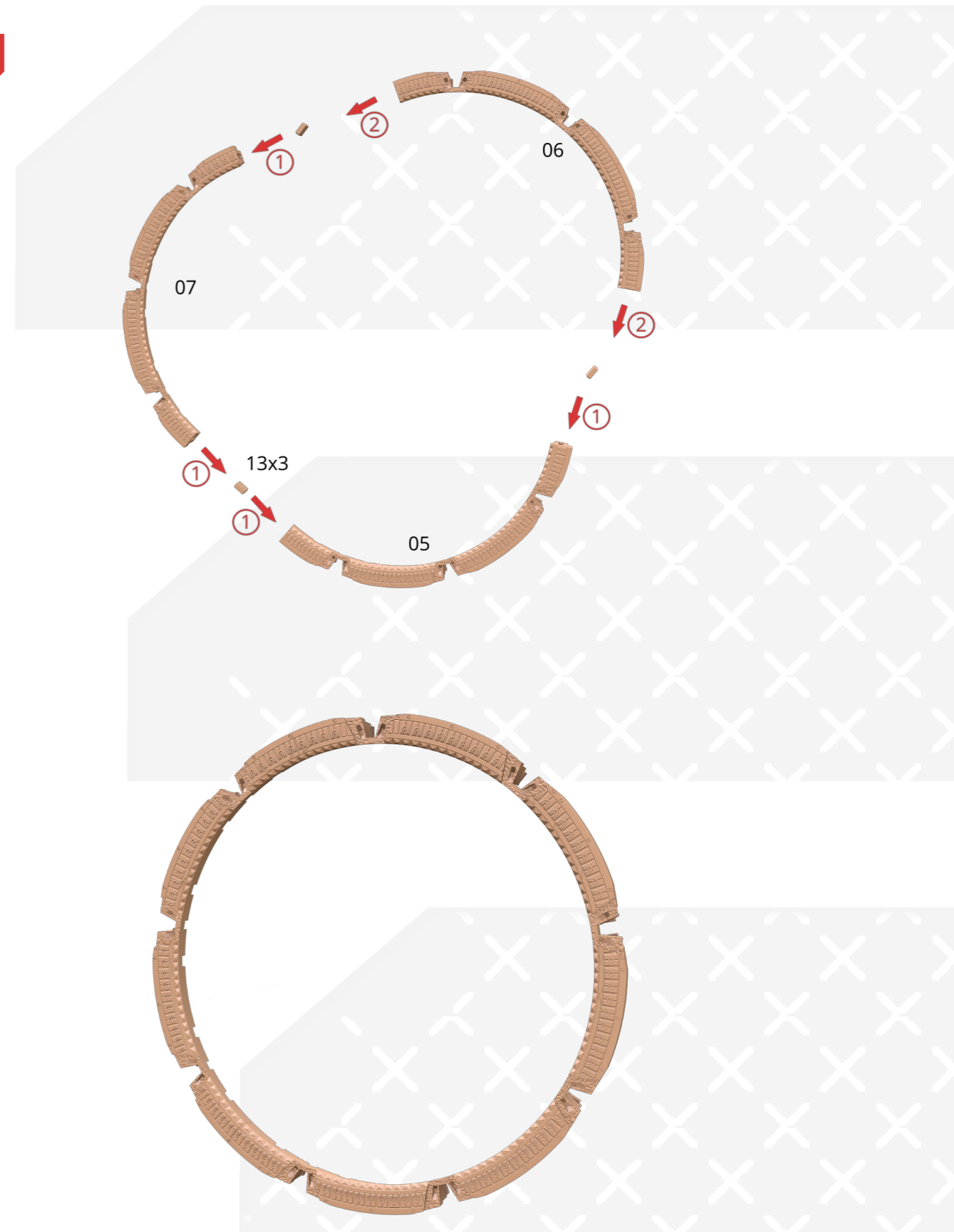

3

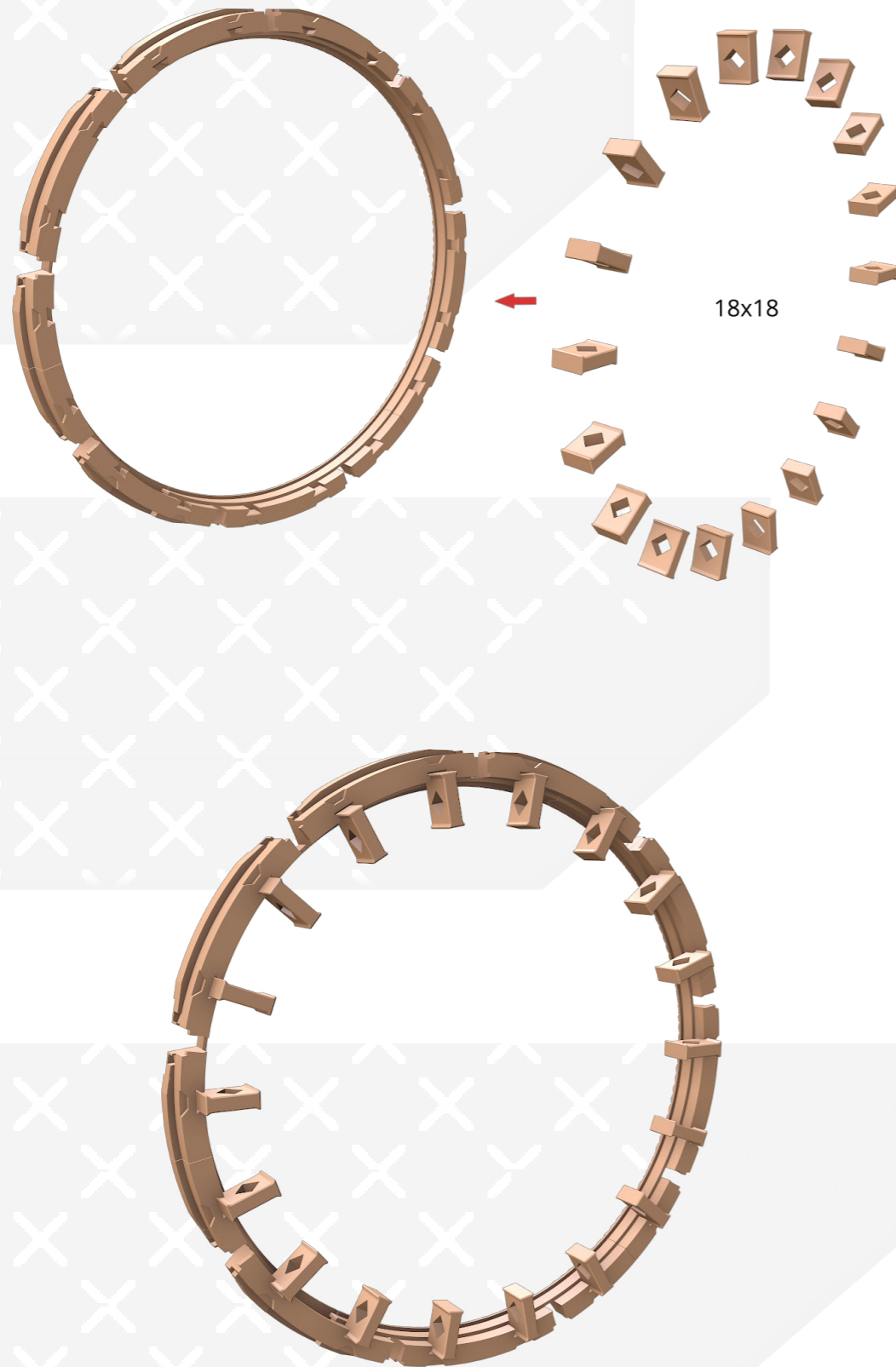

4

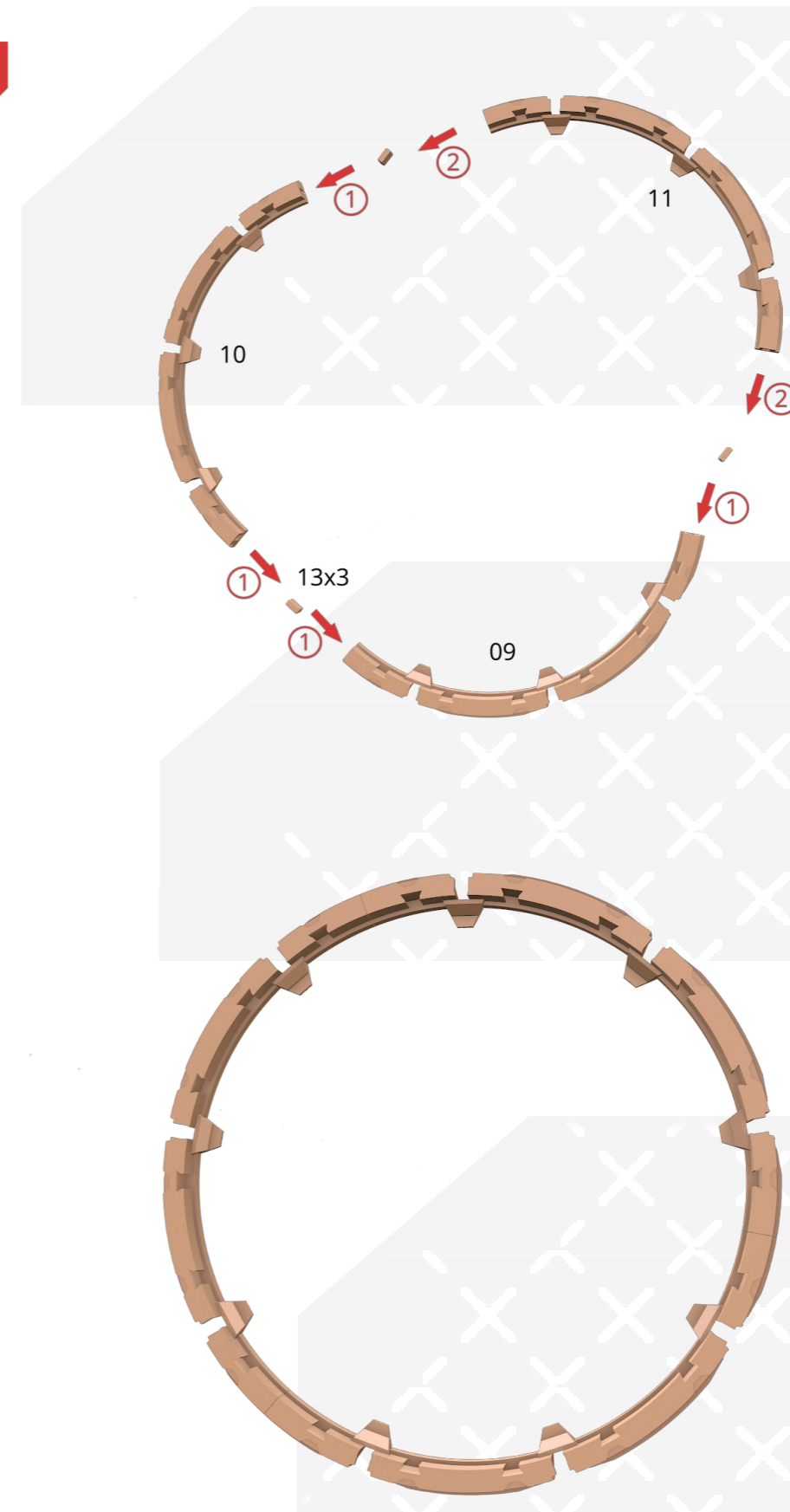

5

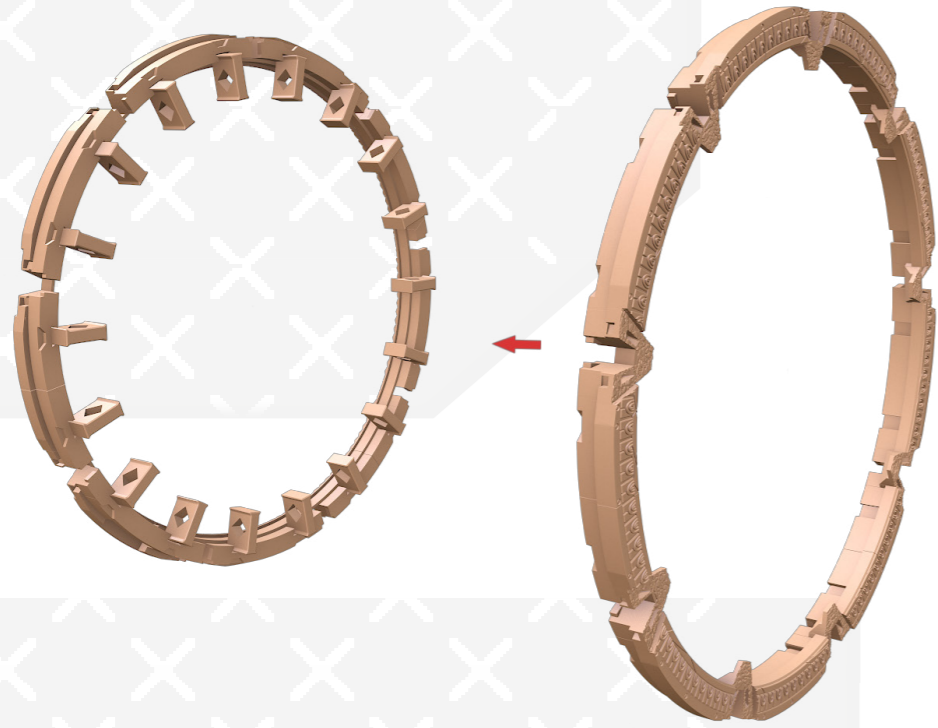

6

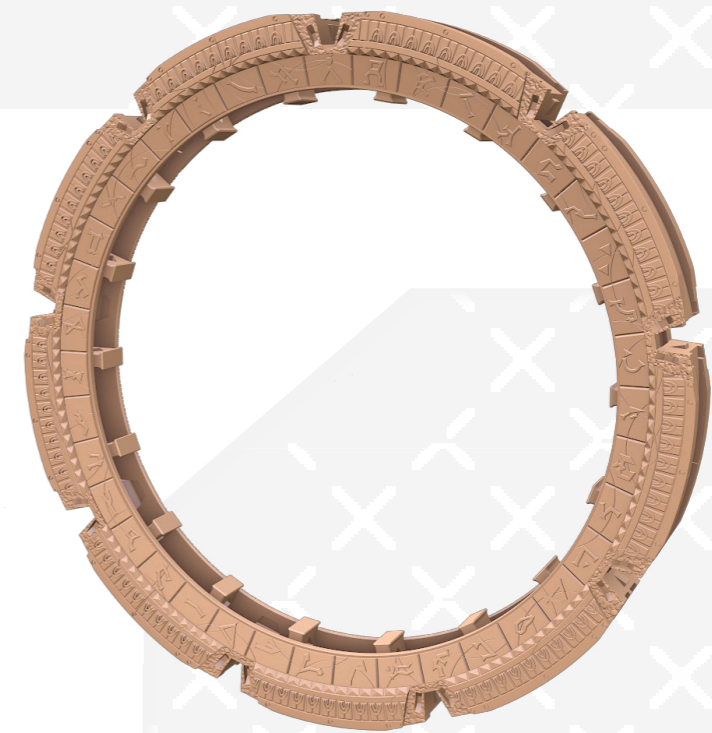
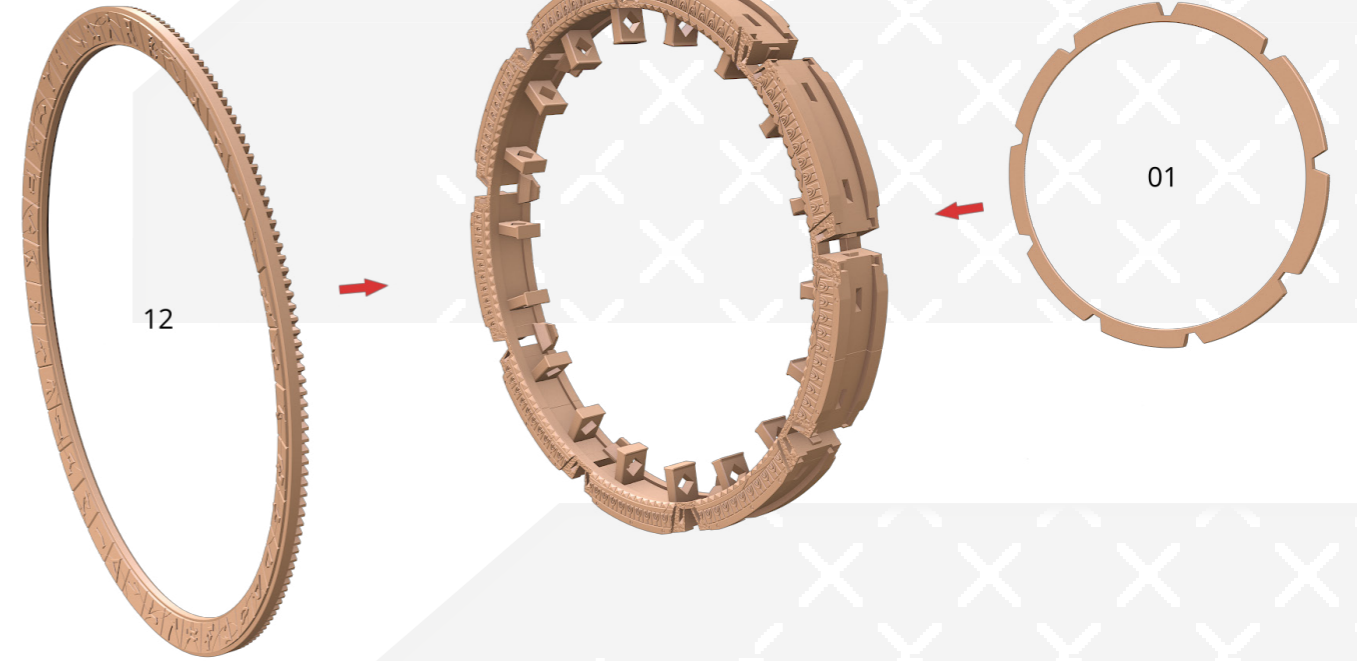

7



8

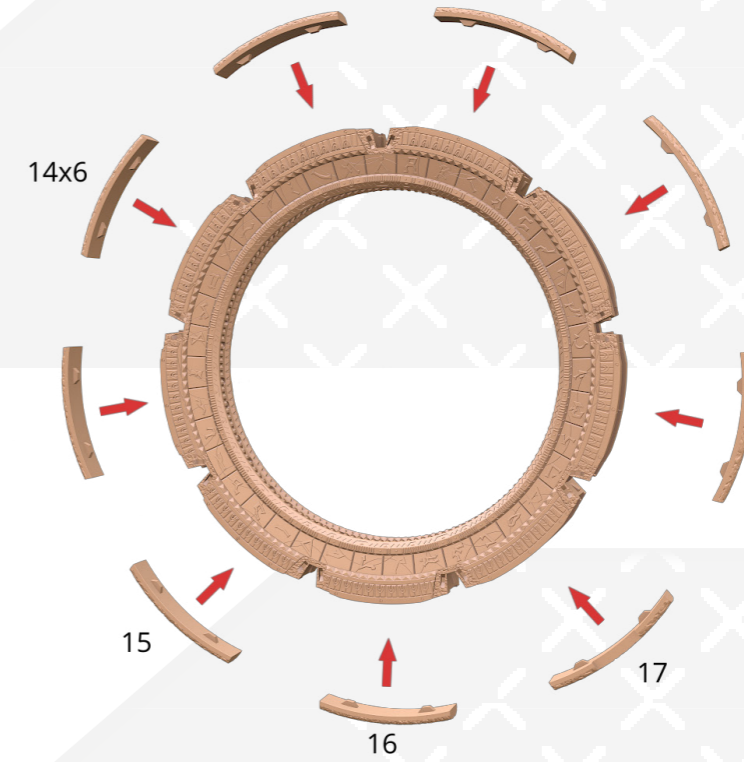

9

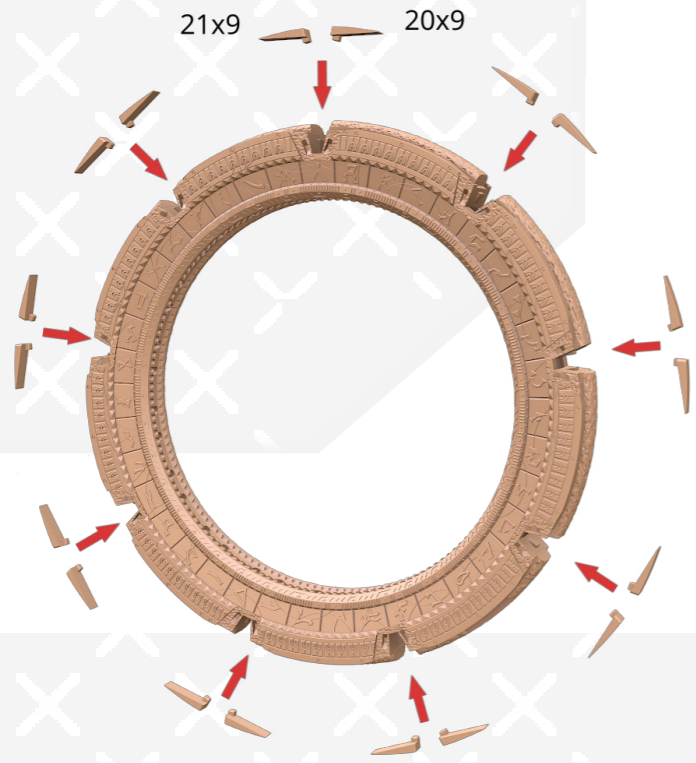

10

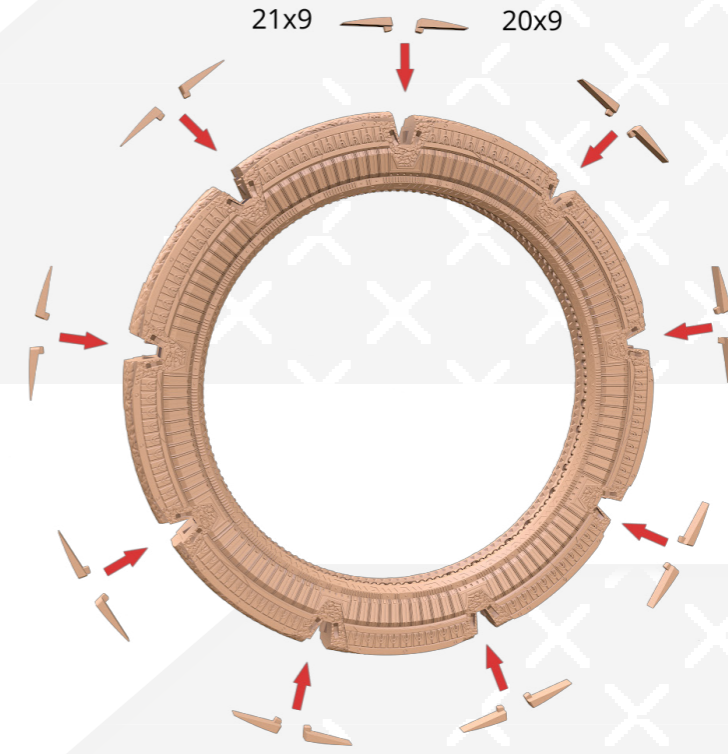

11

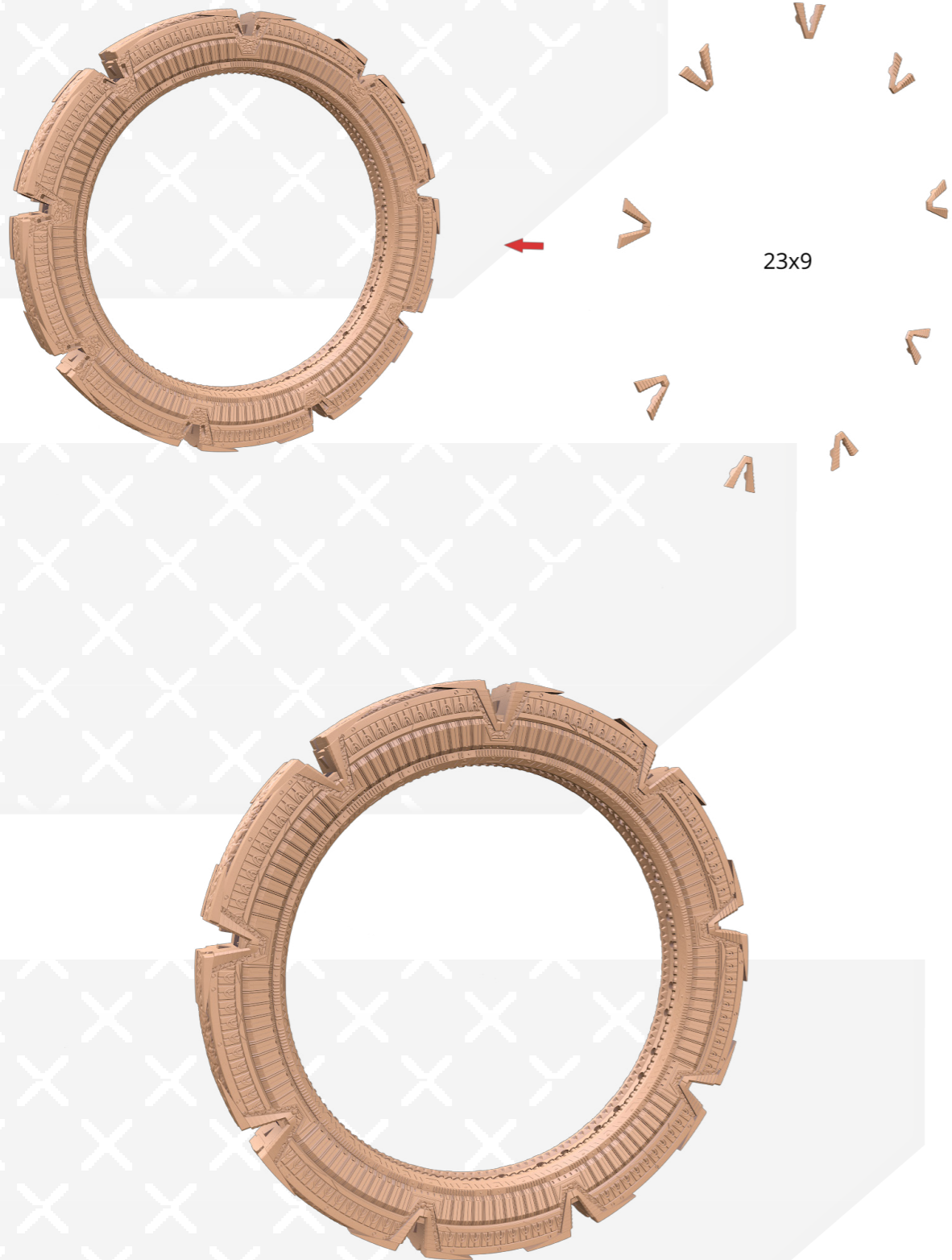

12

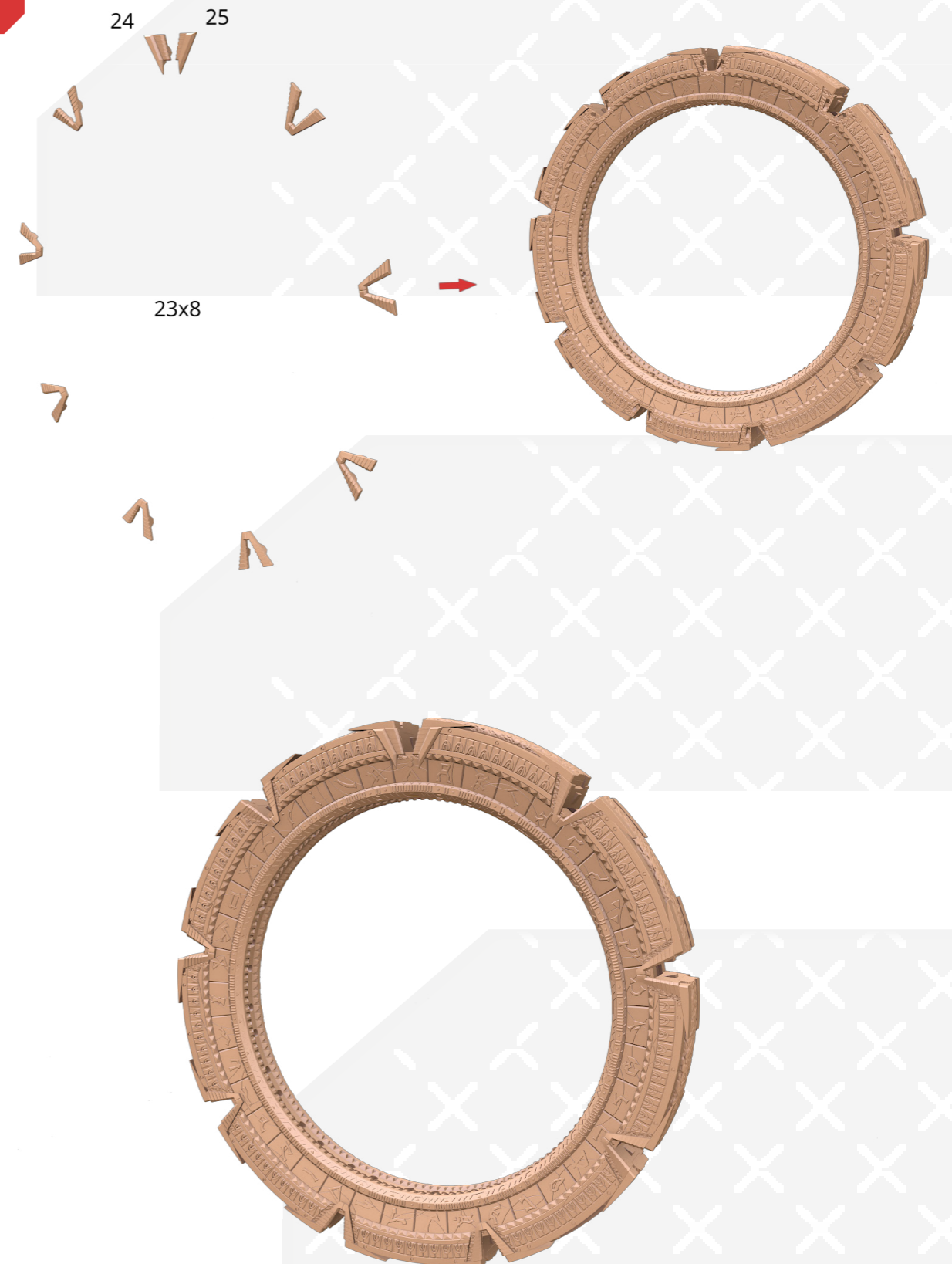

13

REPEAT THIS STEP 8 MORE TIMES

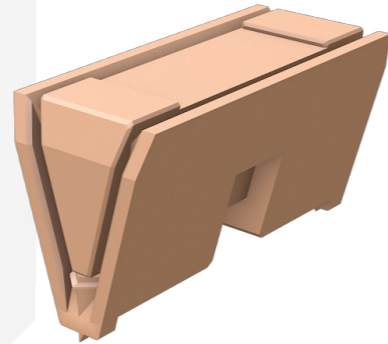
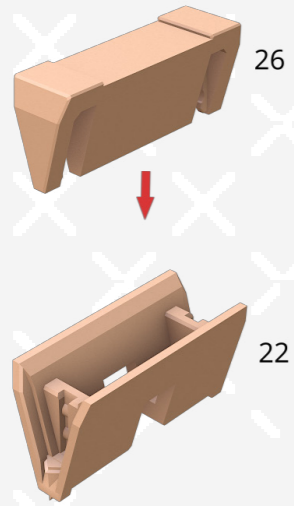

14

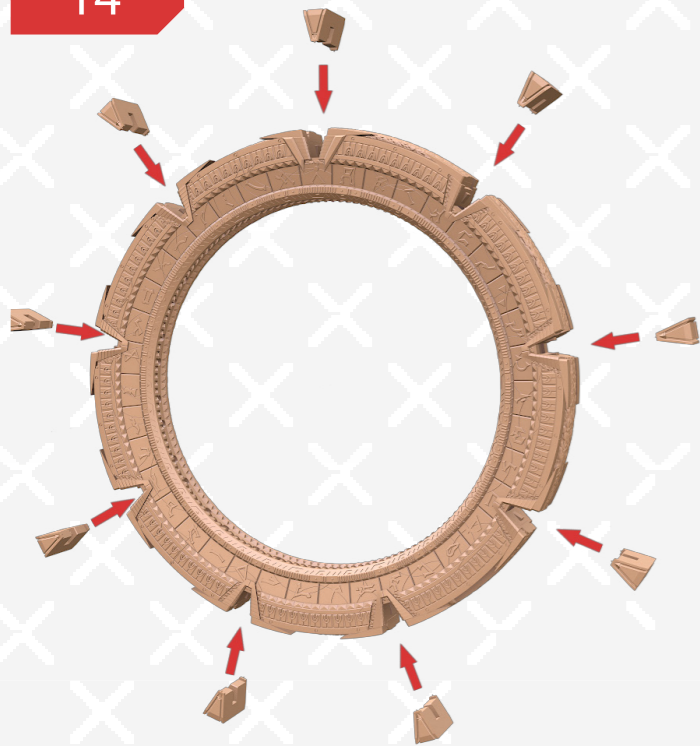

15

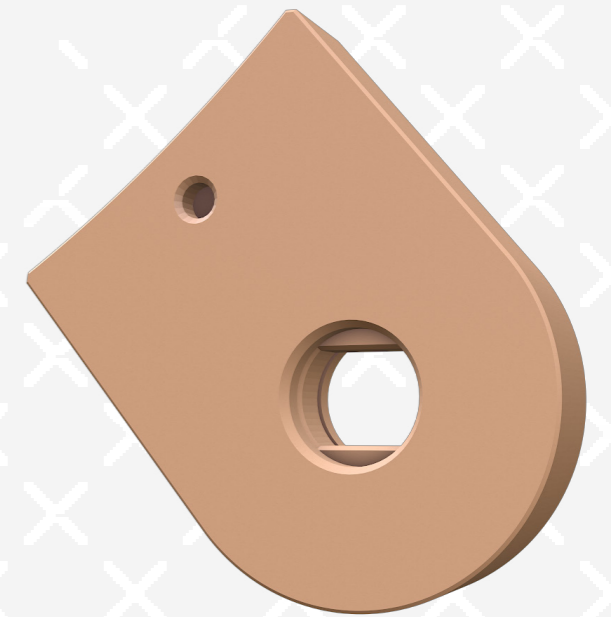
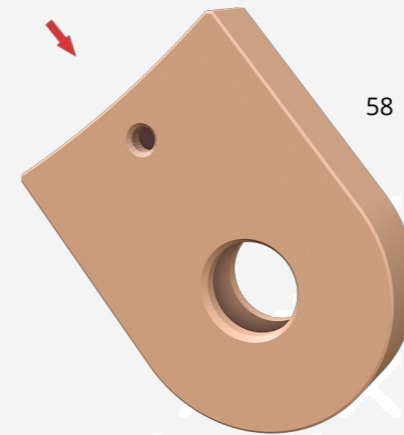
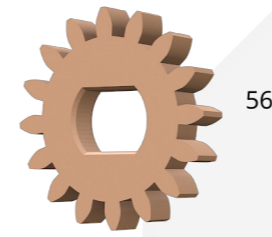

16

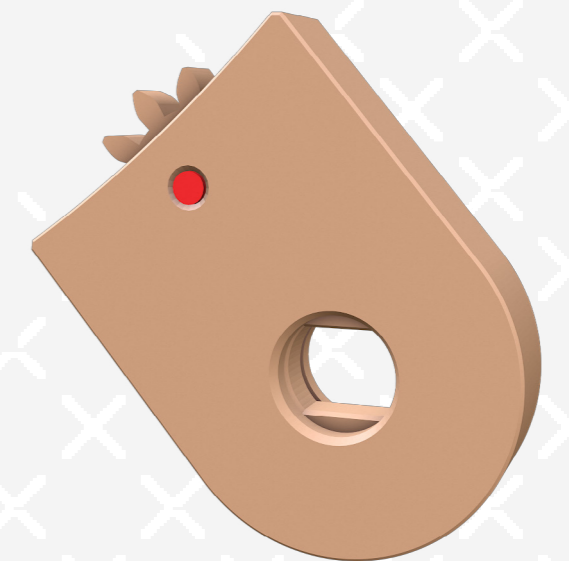
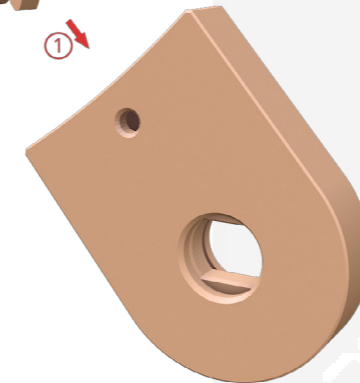
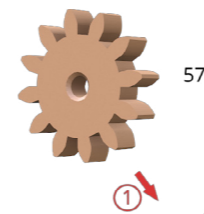



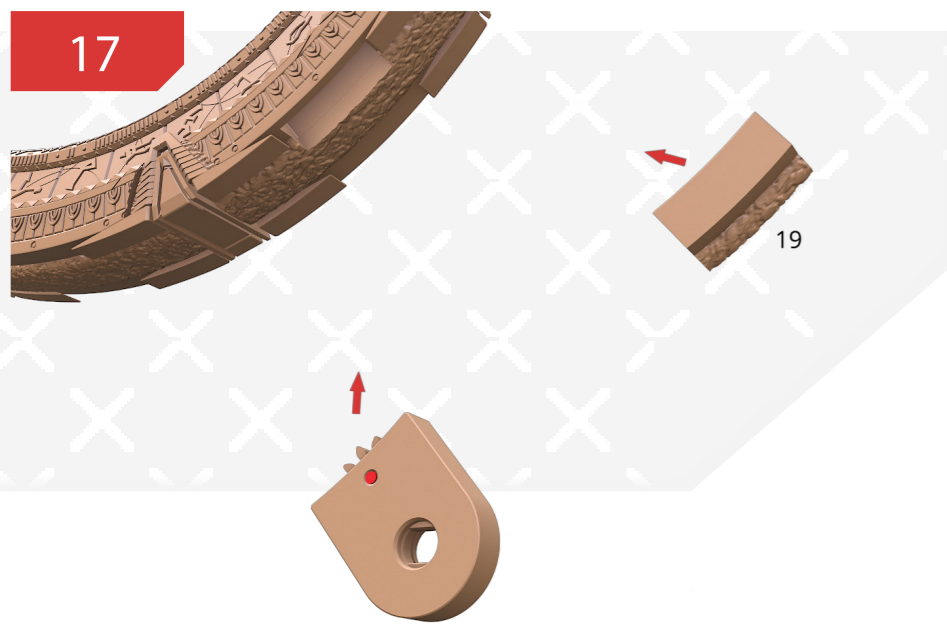

You can install in the ring either a plug or gears to attach to the control panel to turn the ring with constellations.

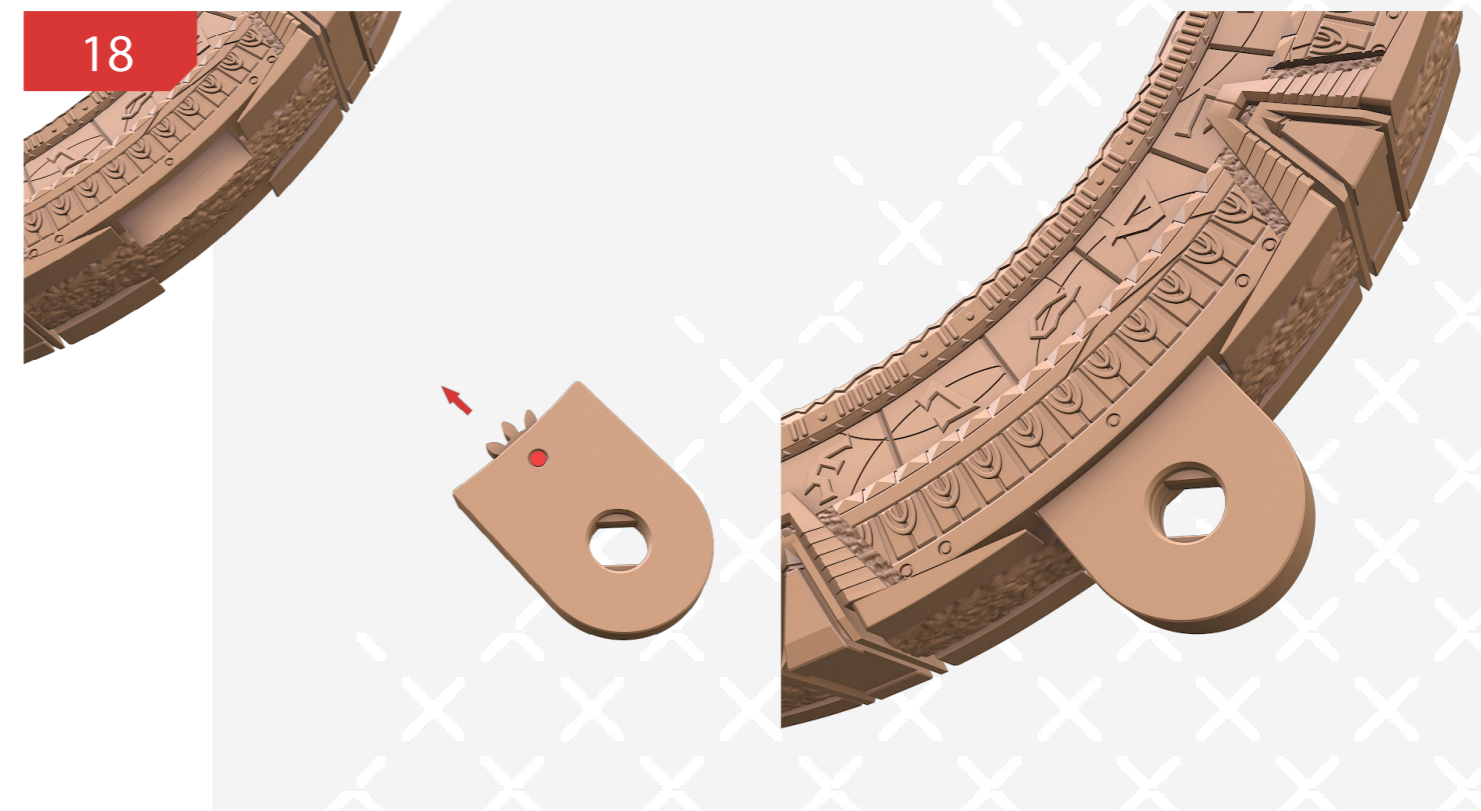

19

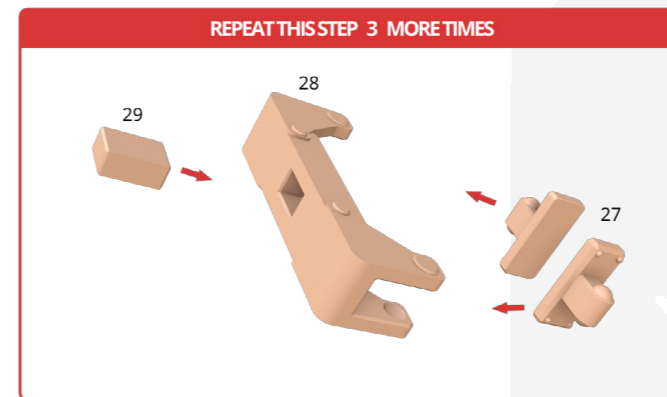

REPEAT THIS STEP 3 MORE TIMES

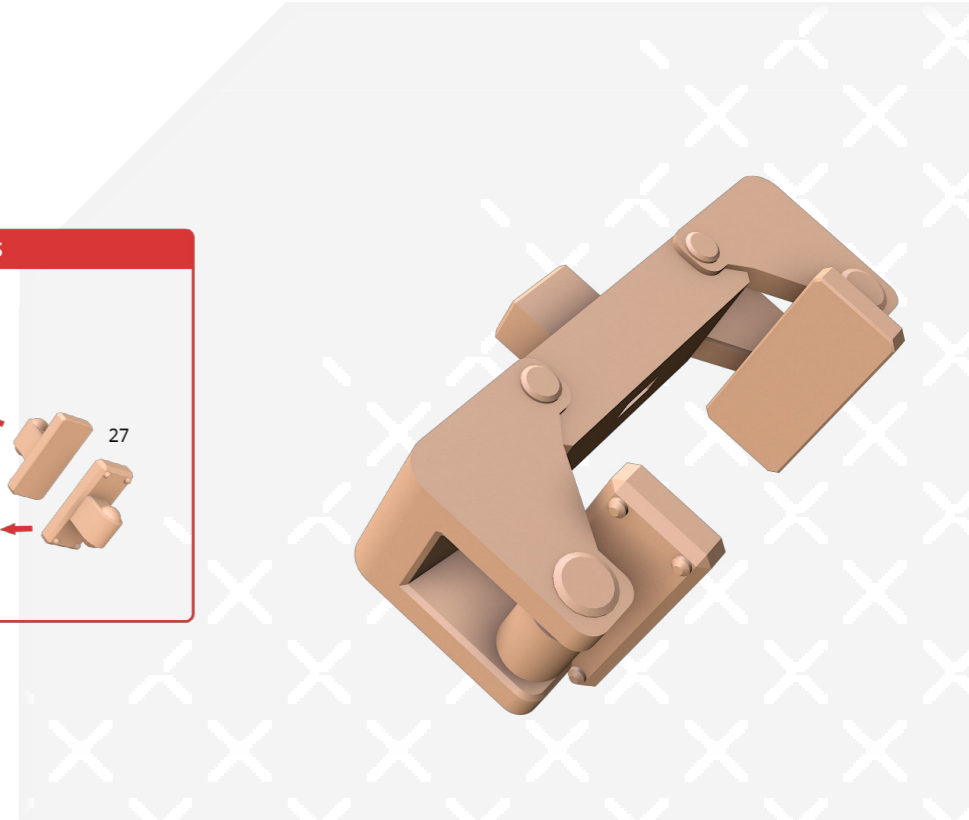

20

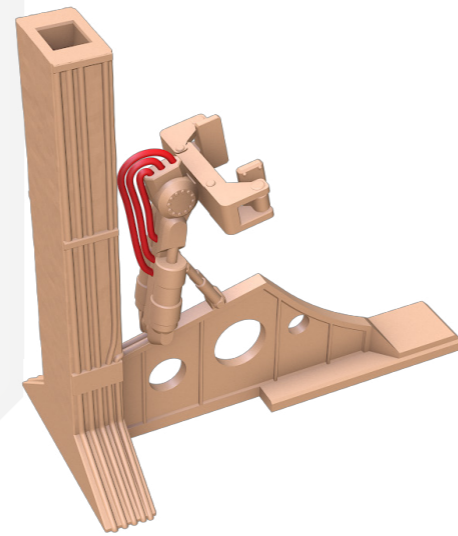
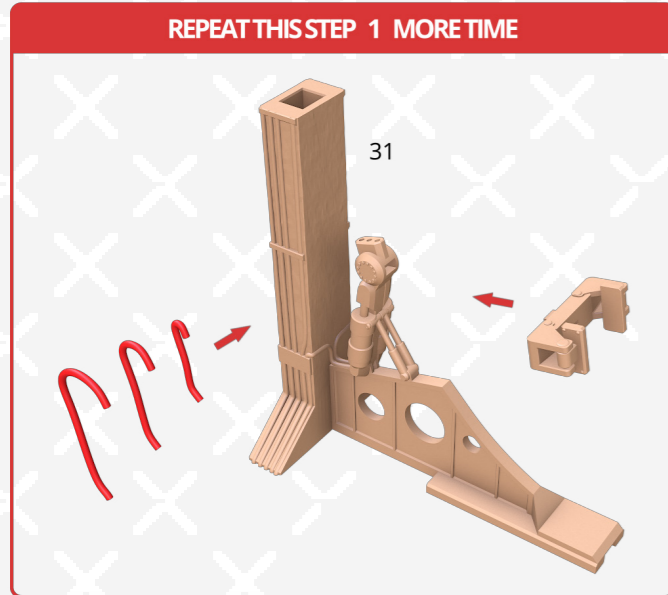

21

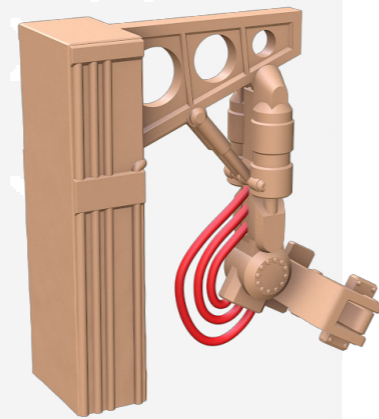
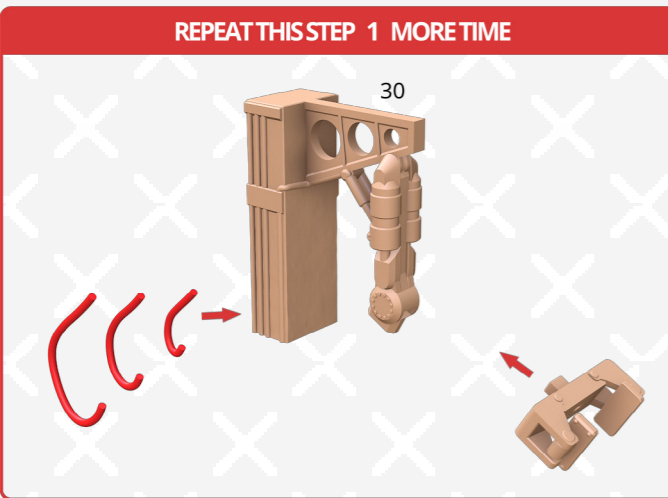

22

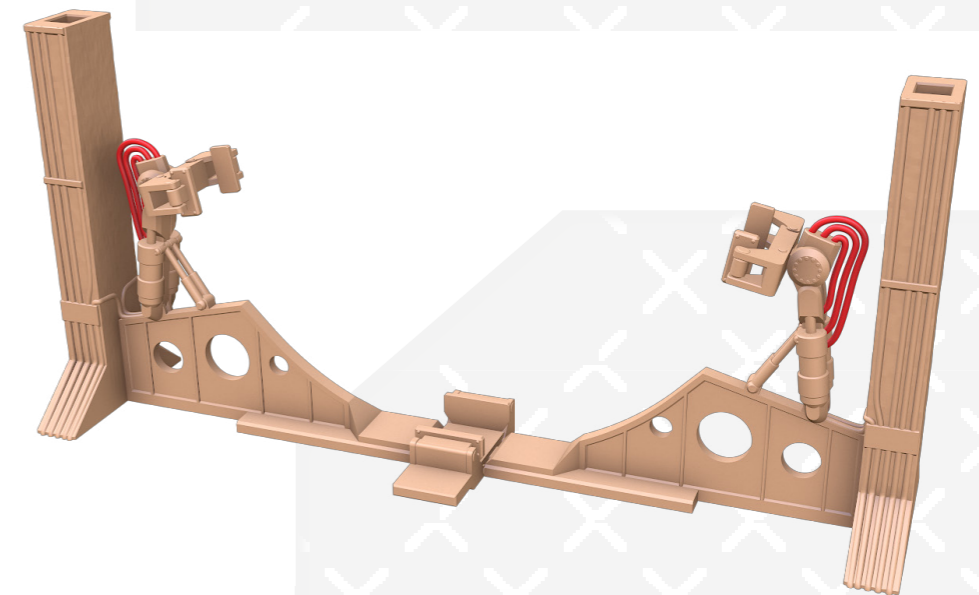
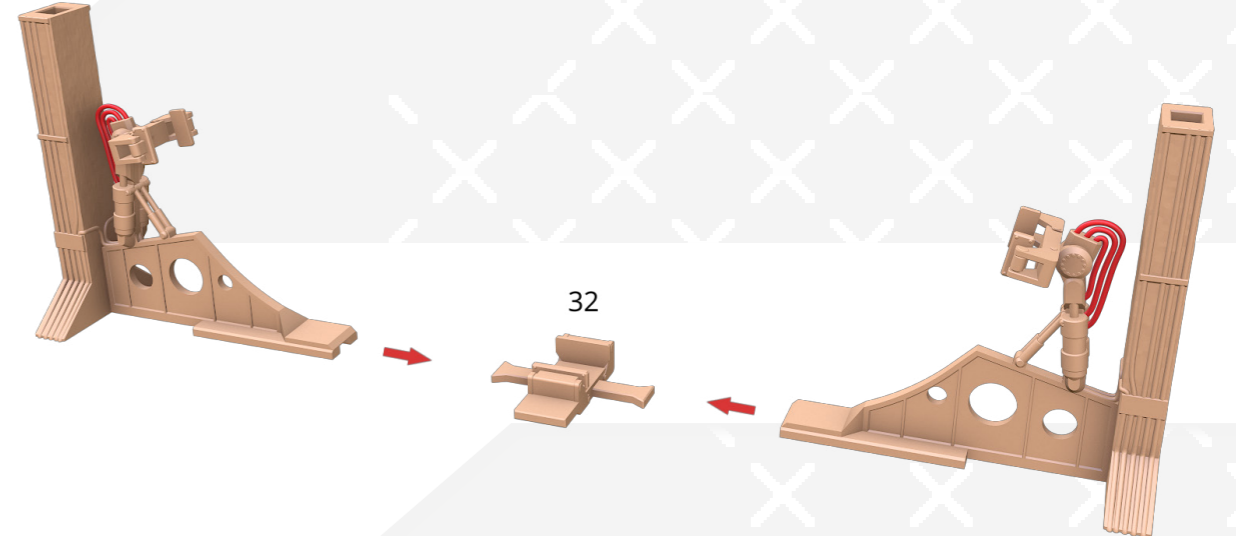

23

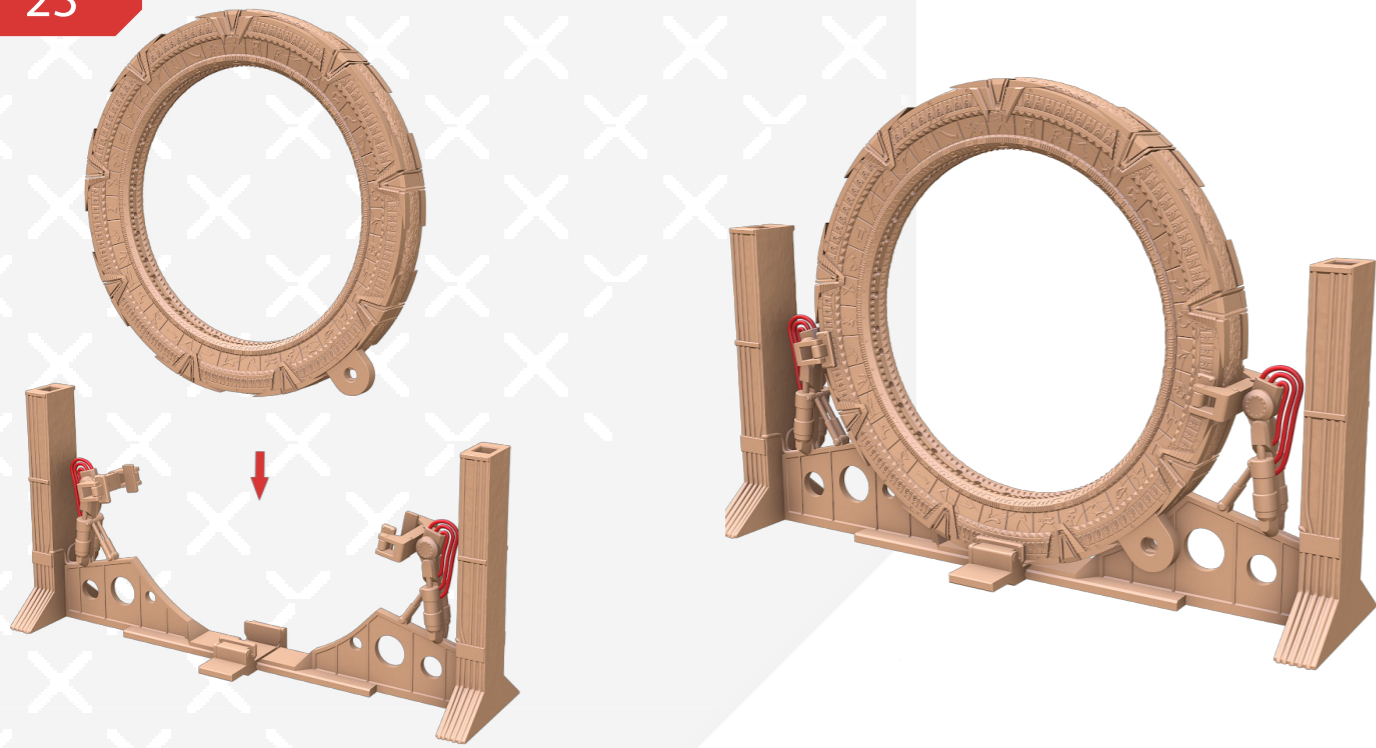

24



25

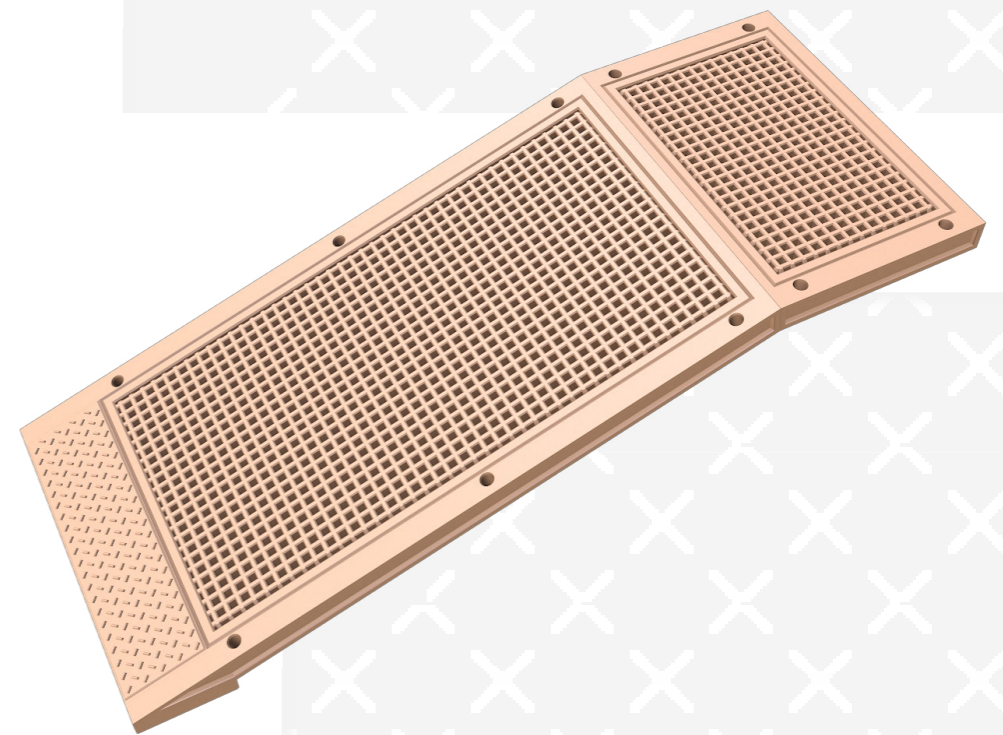
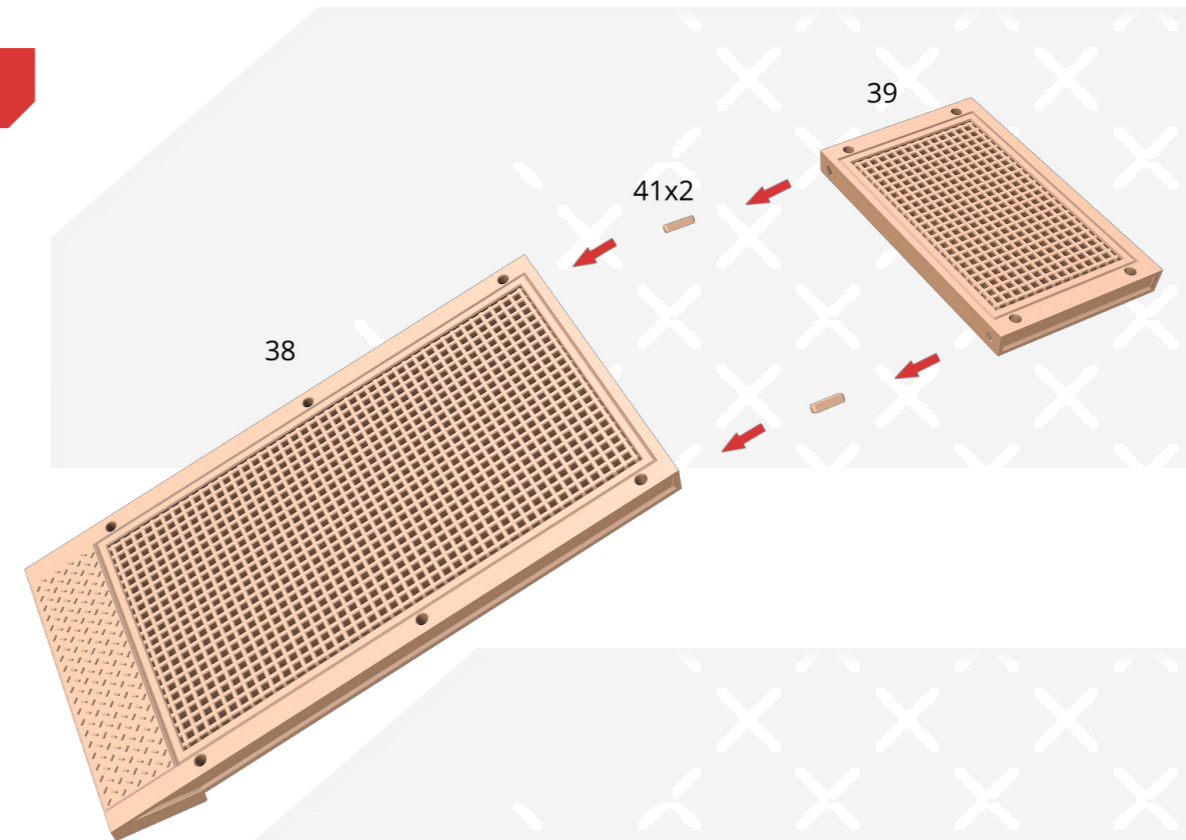

26

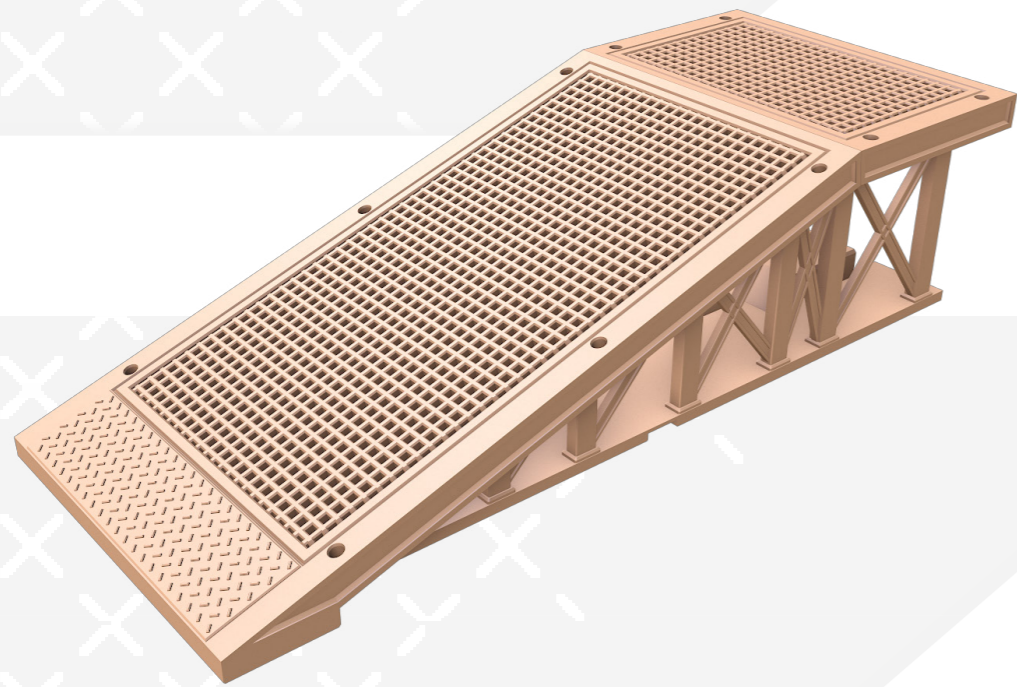
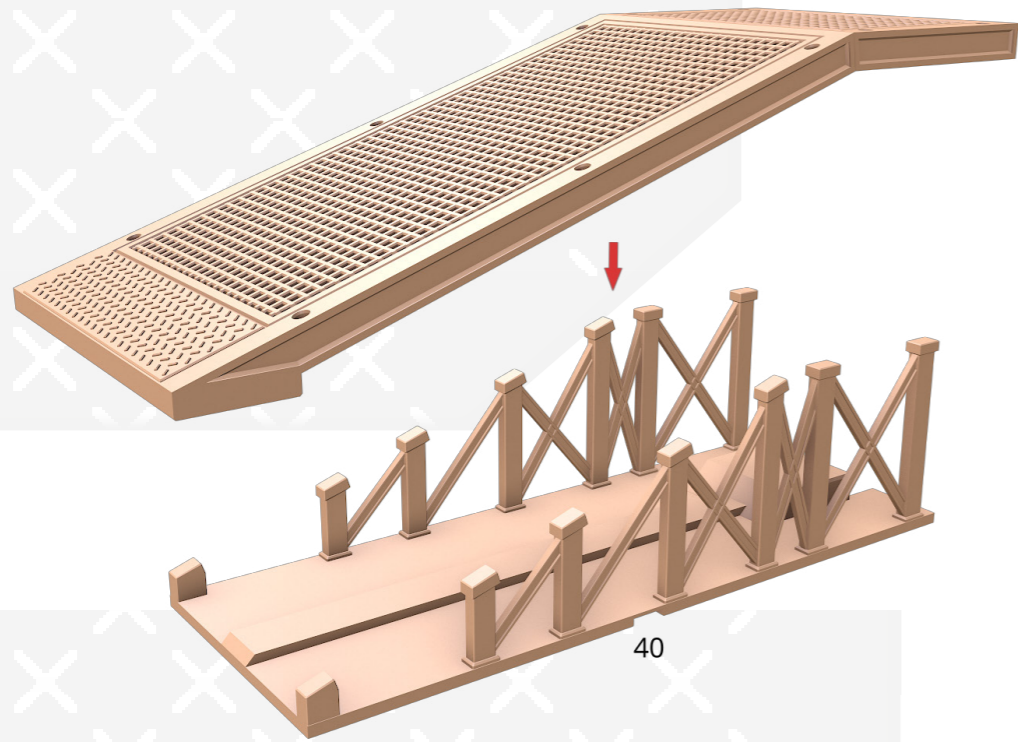

27

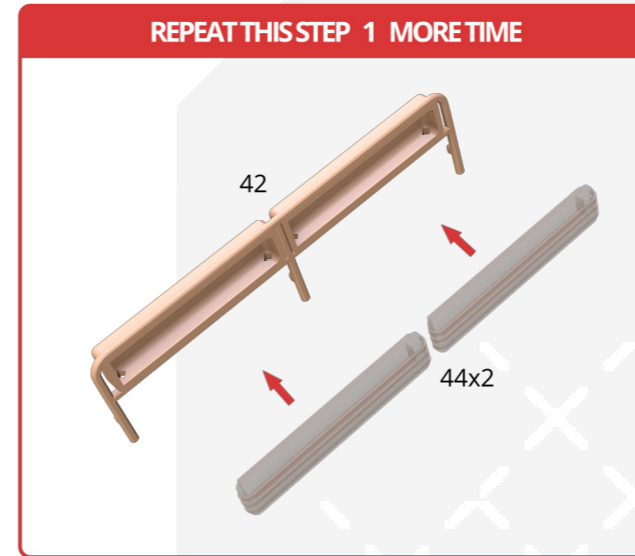

28

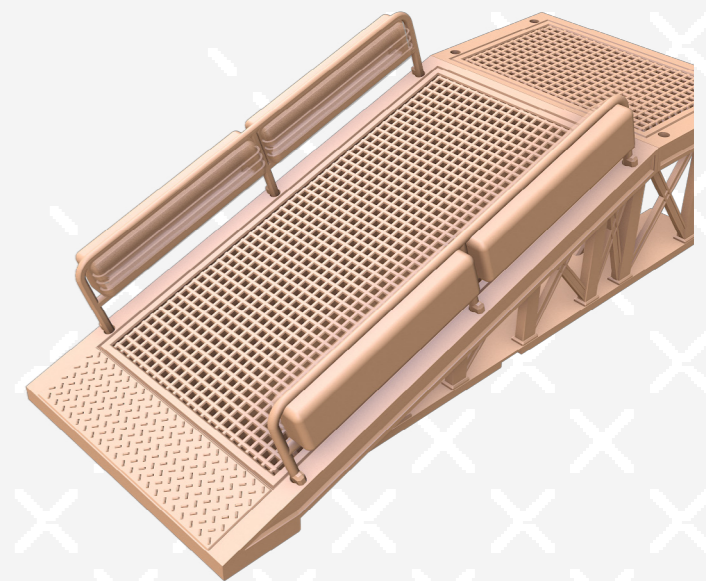
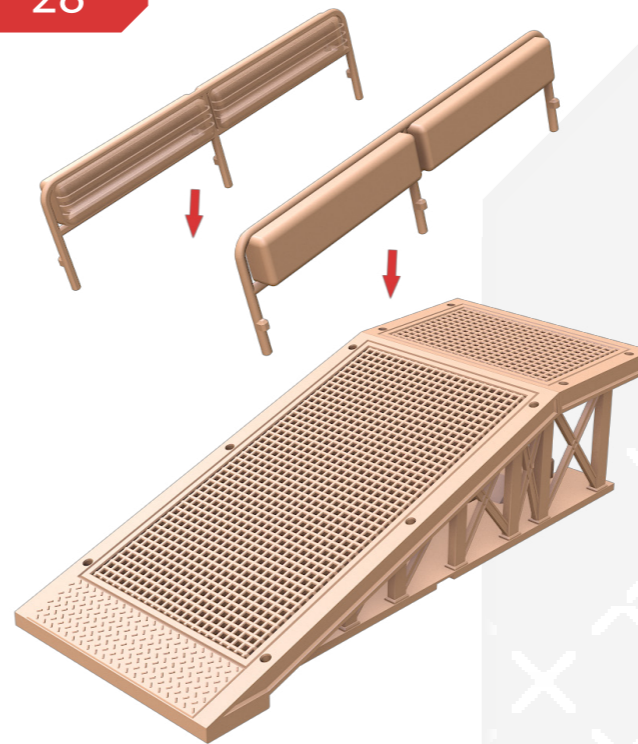

29

REPEAT THIS STEP 1 MORE TIME

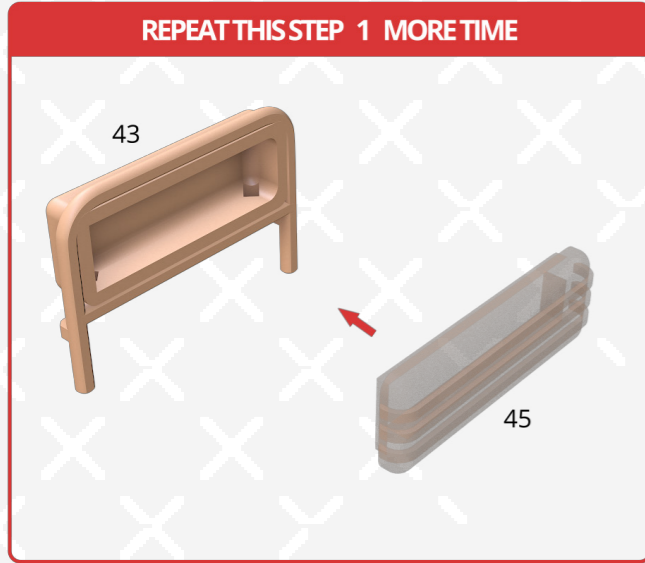

30

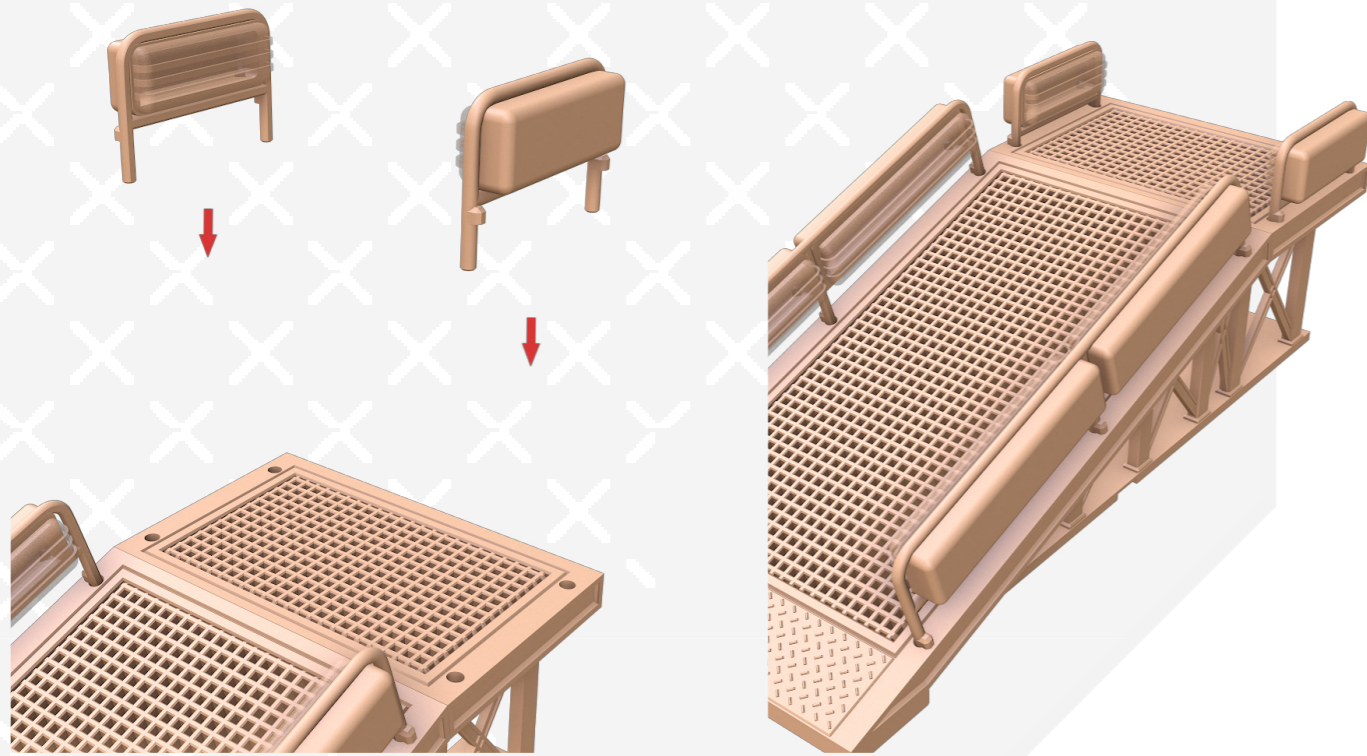

31

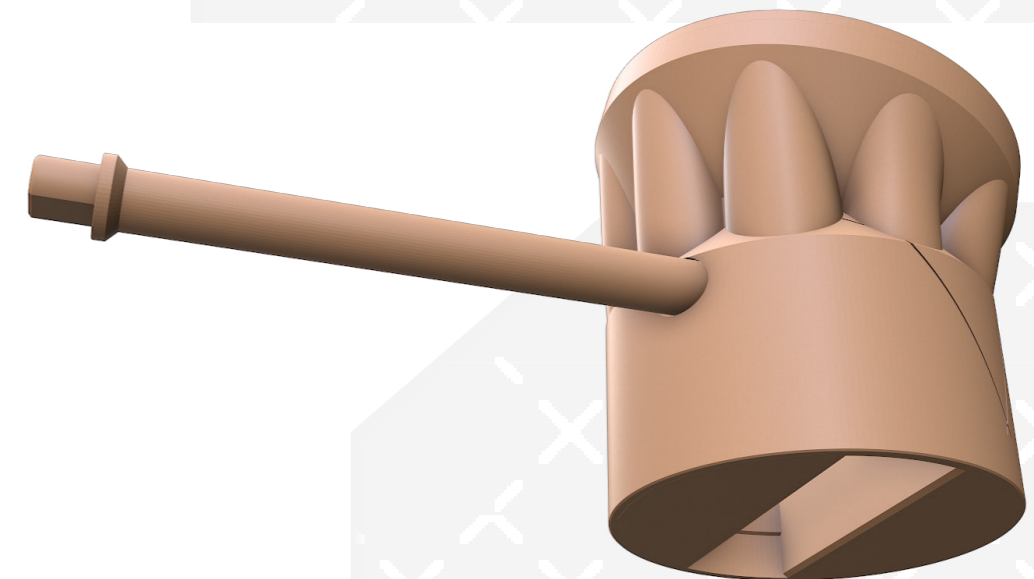
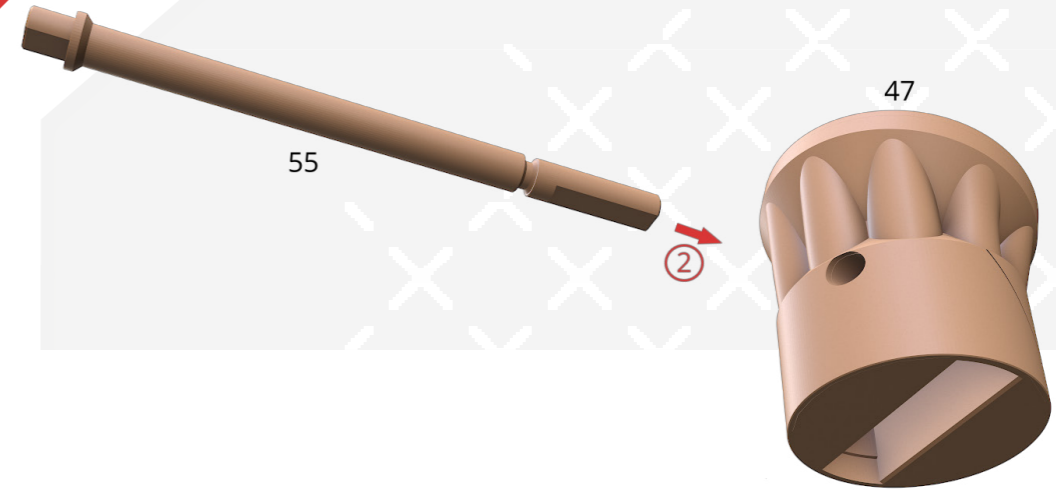

32

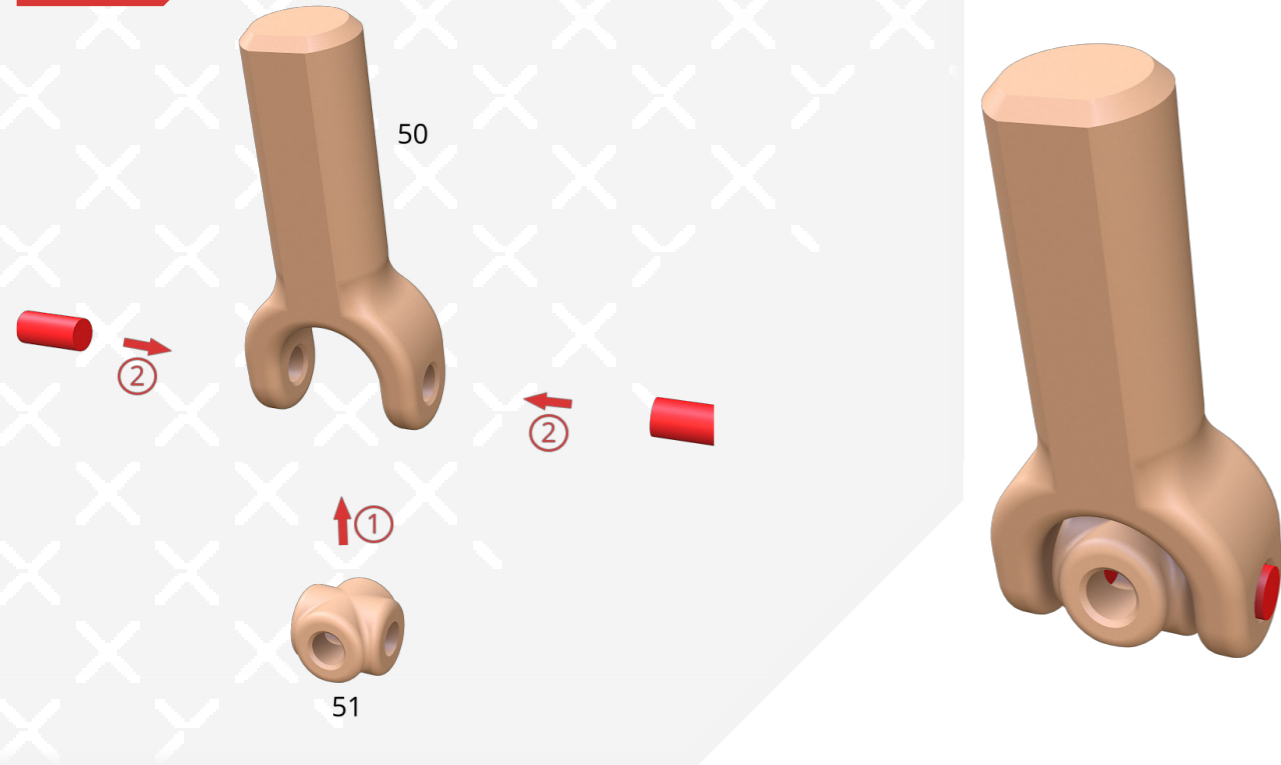

33

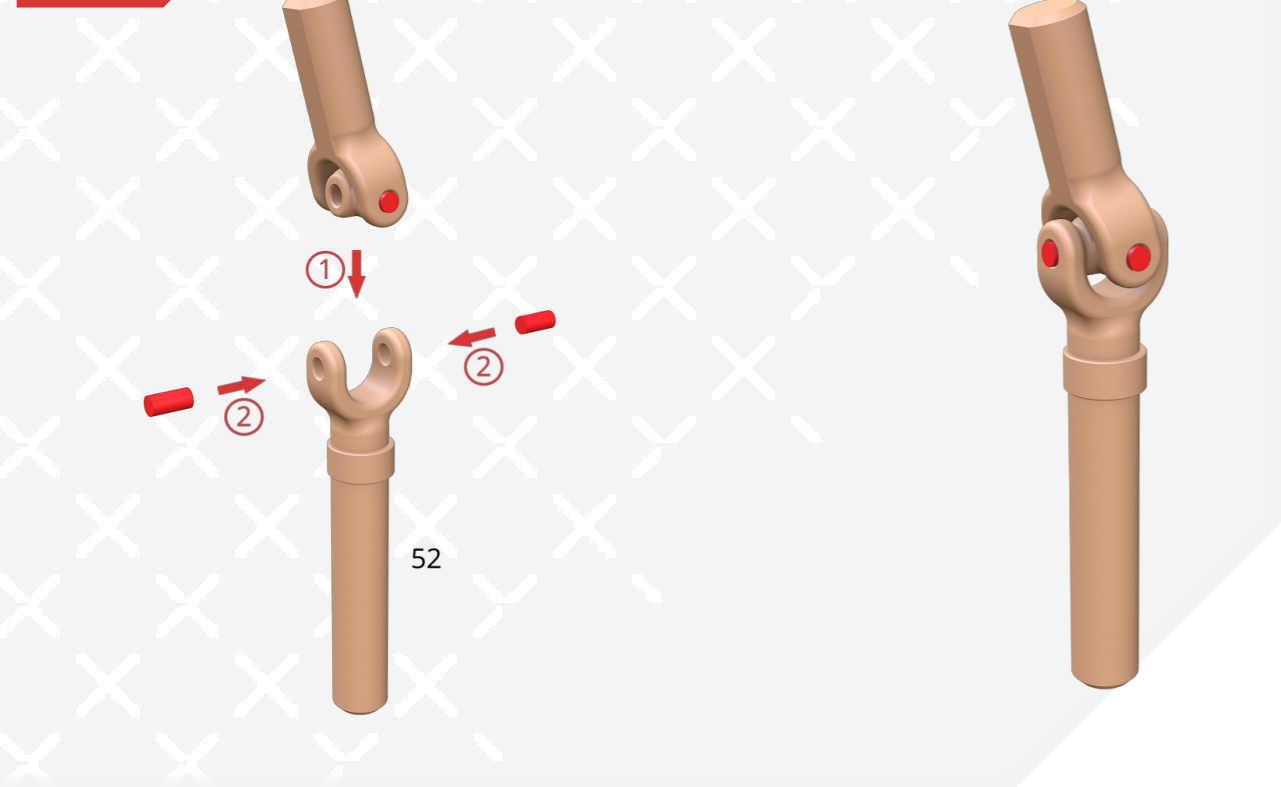

34

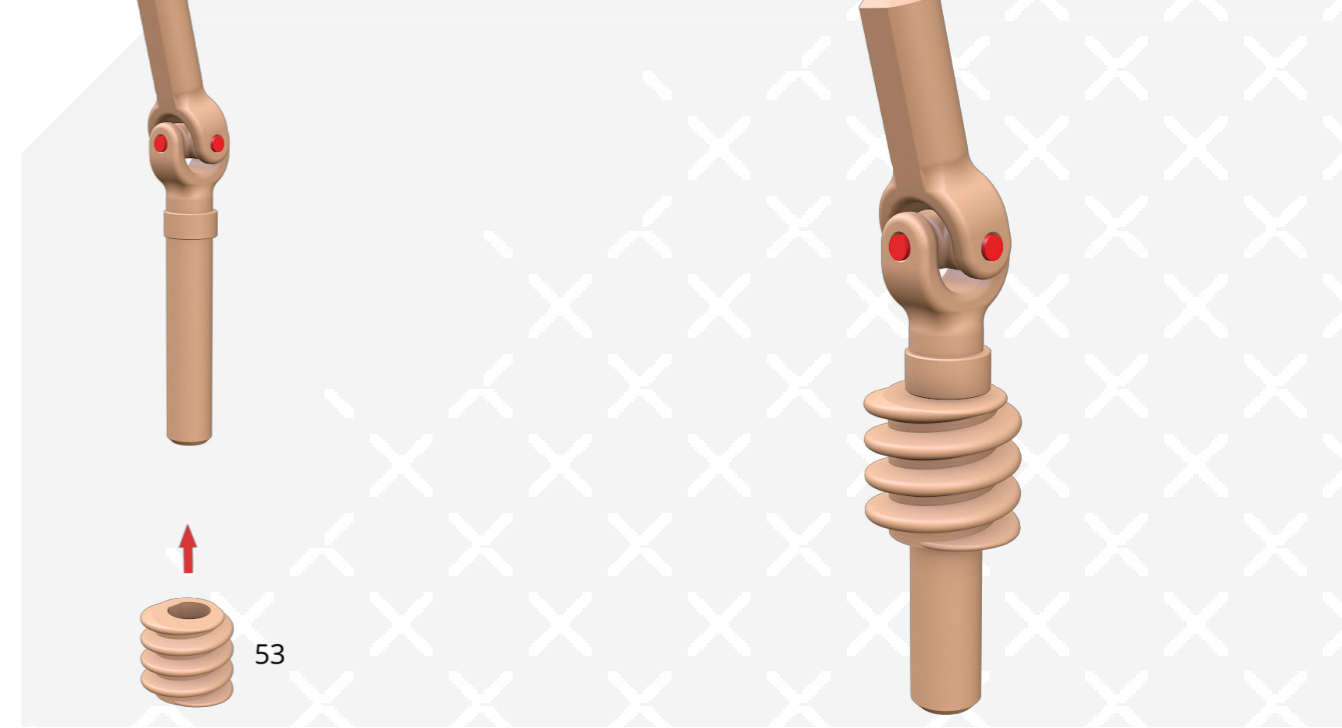

35

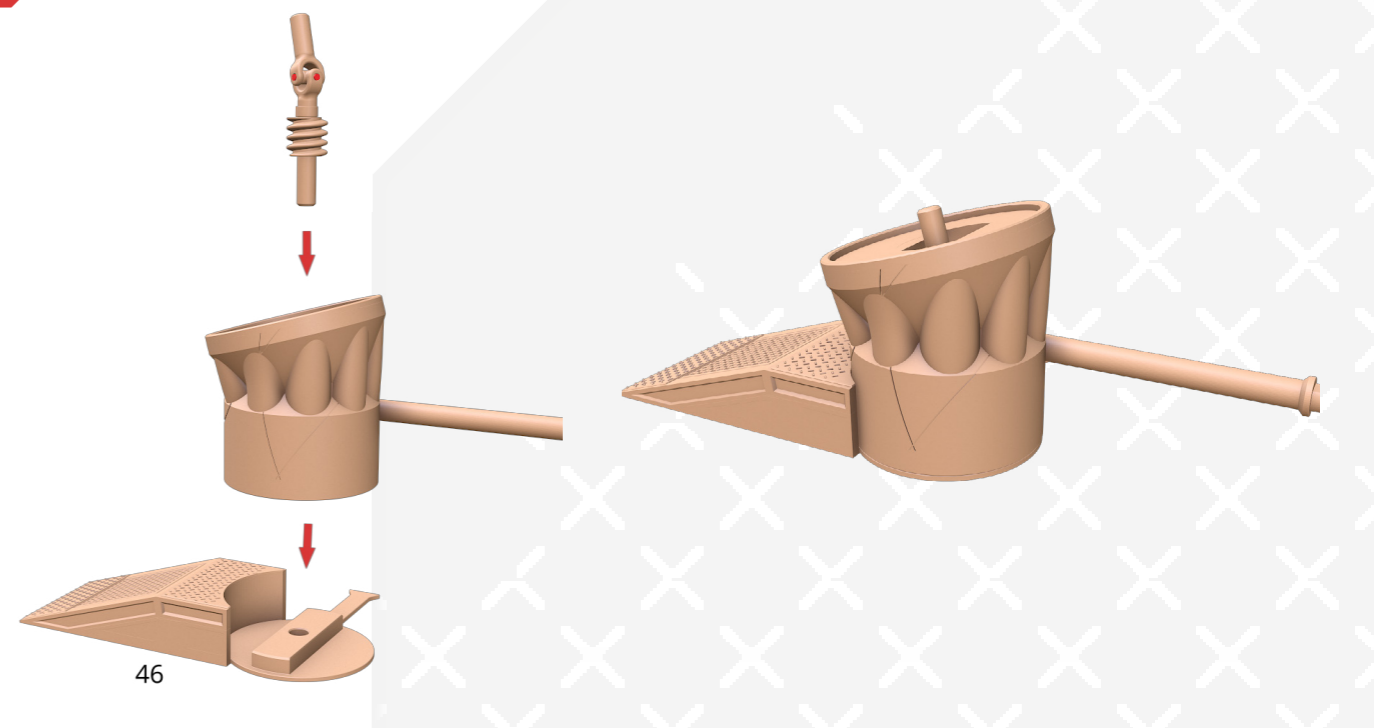

36

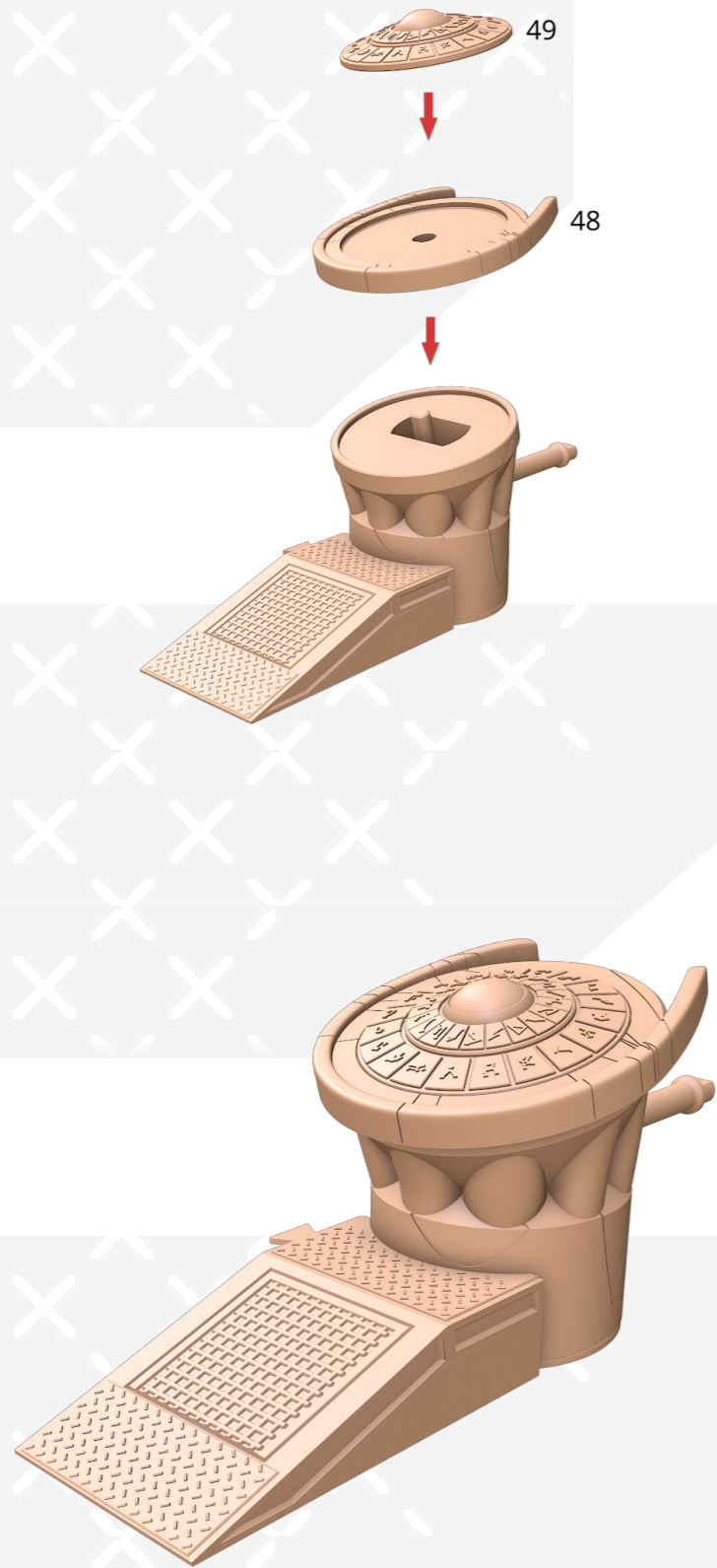

37

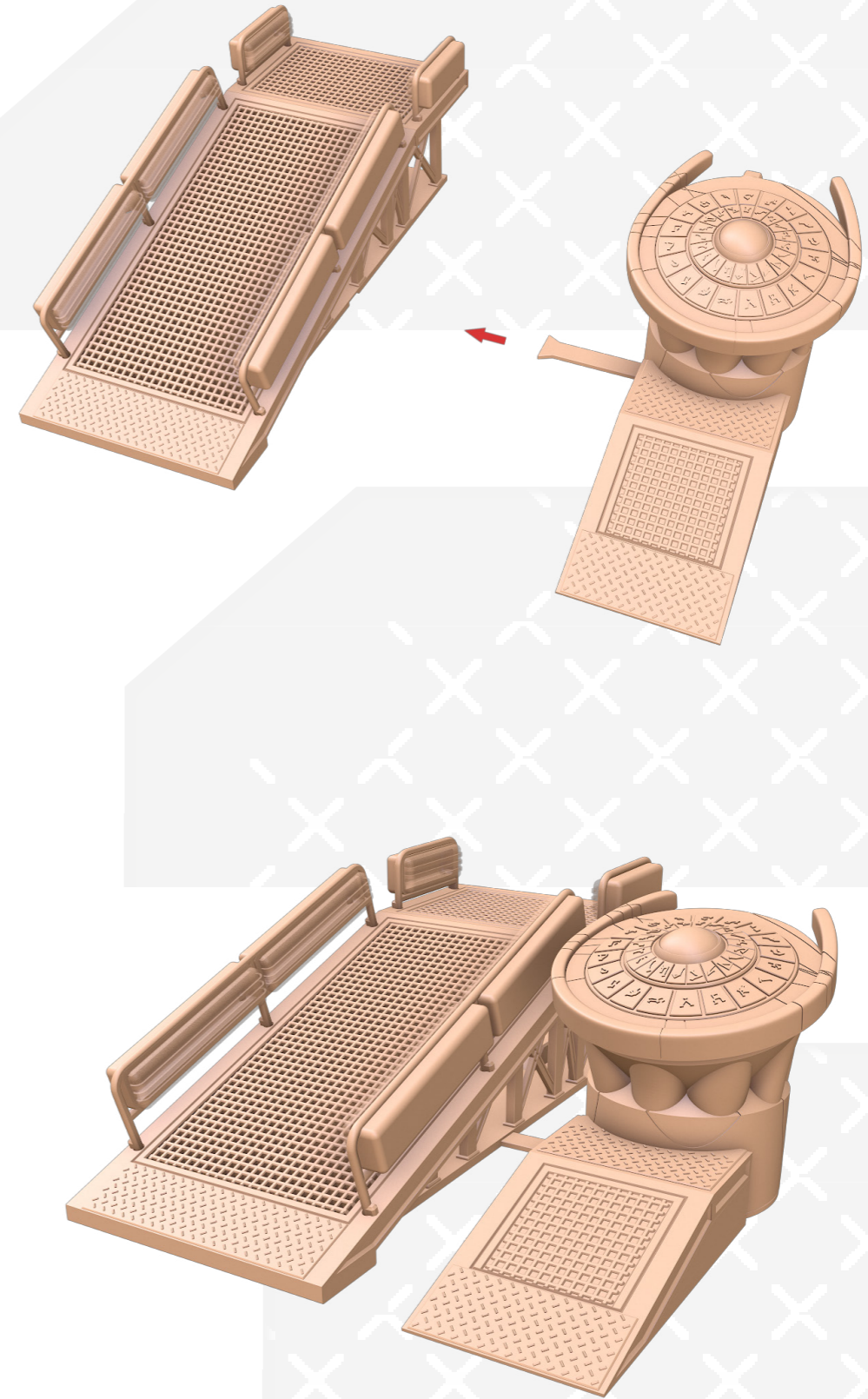

38

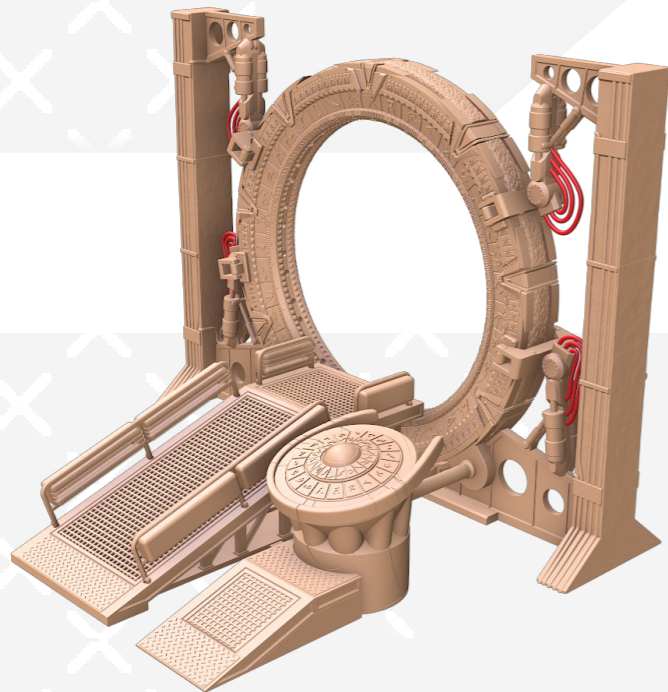
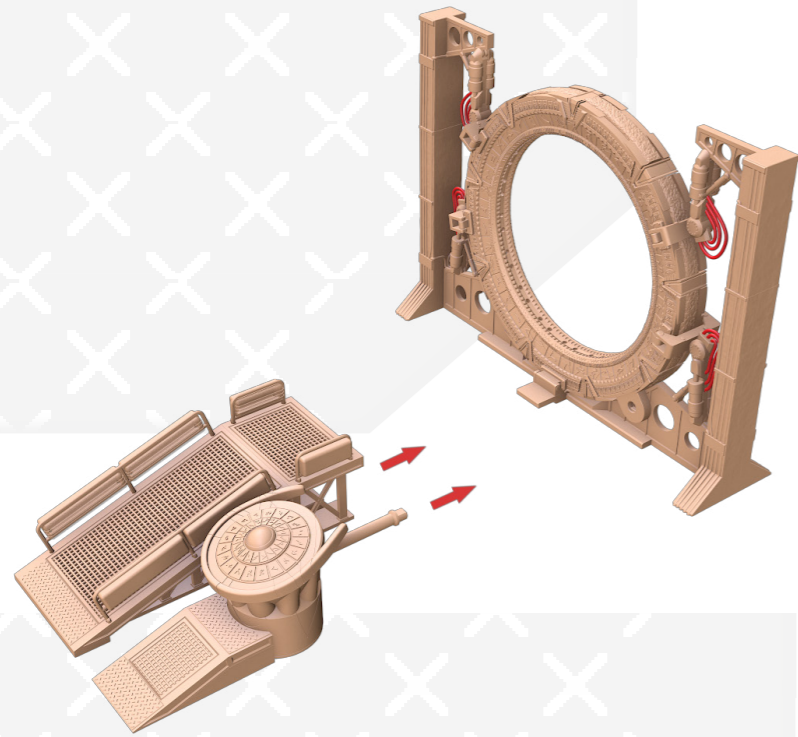

39

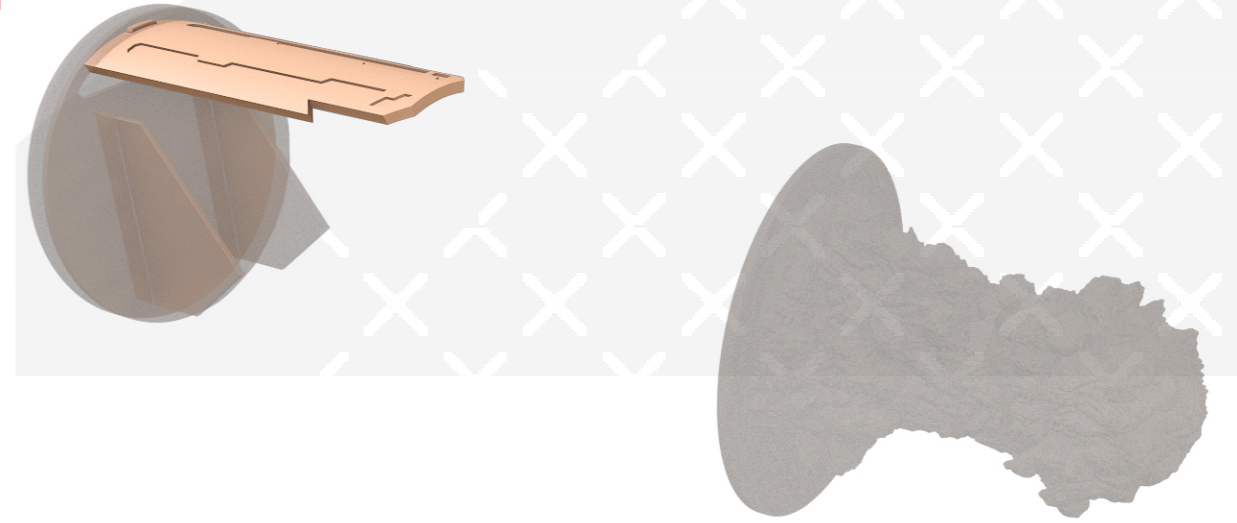

4 variants of the wormhole.

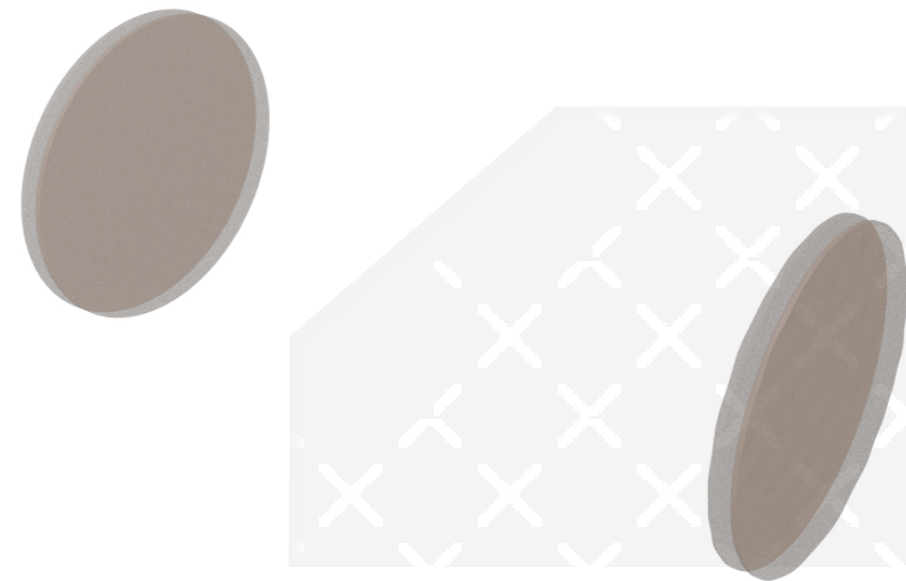



40

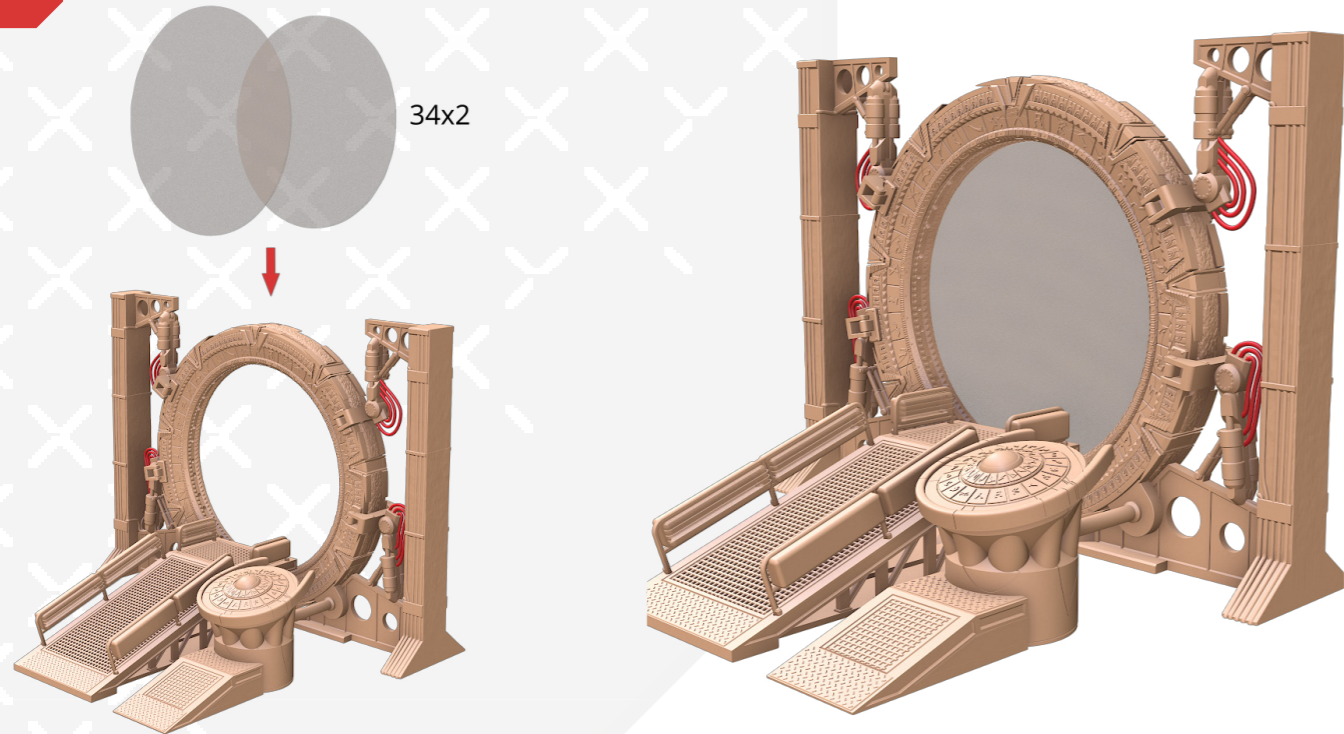

41



42

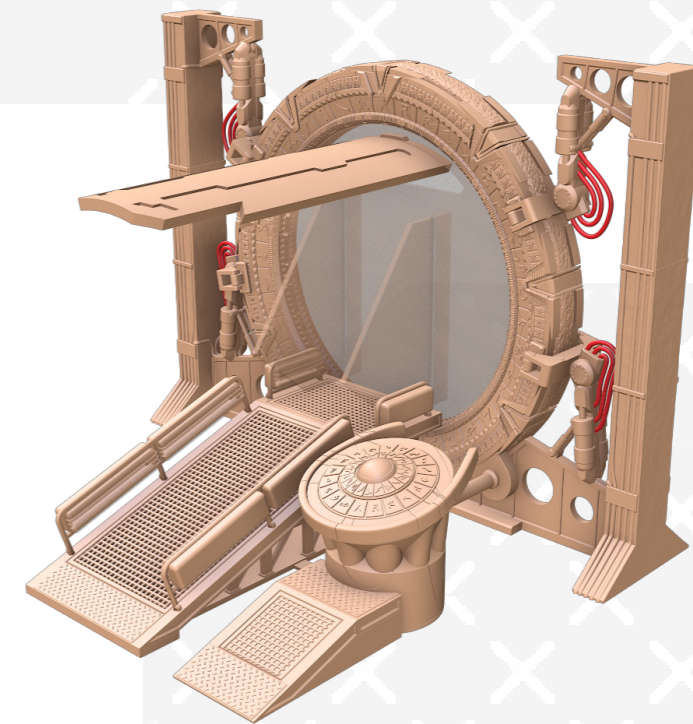
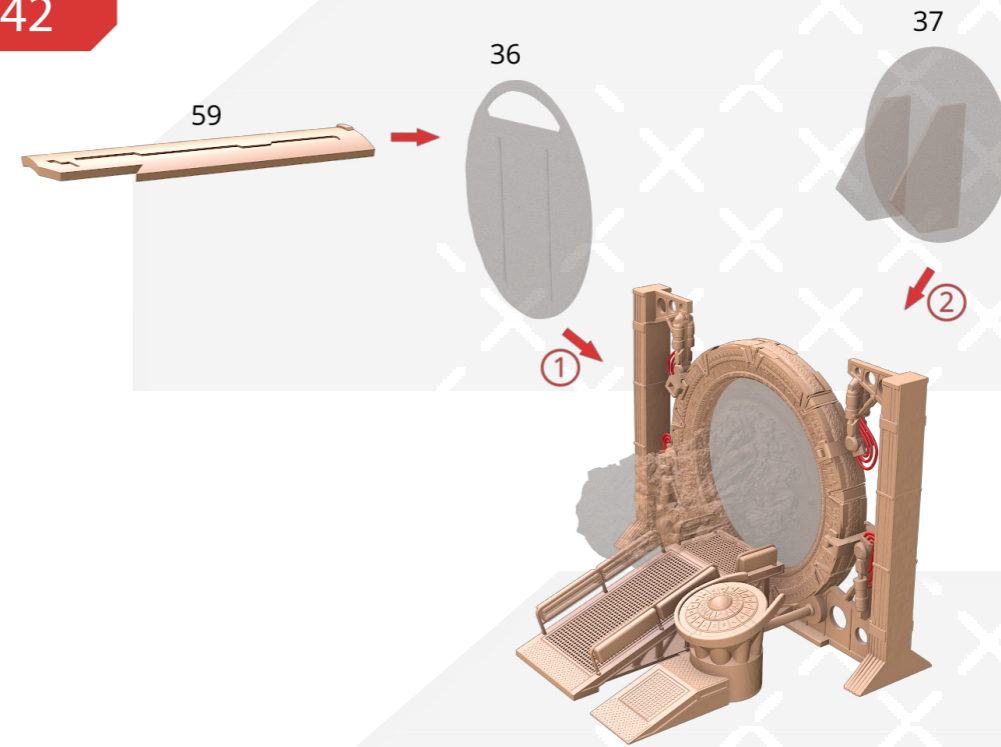

43

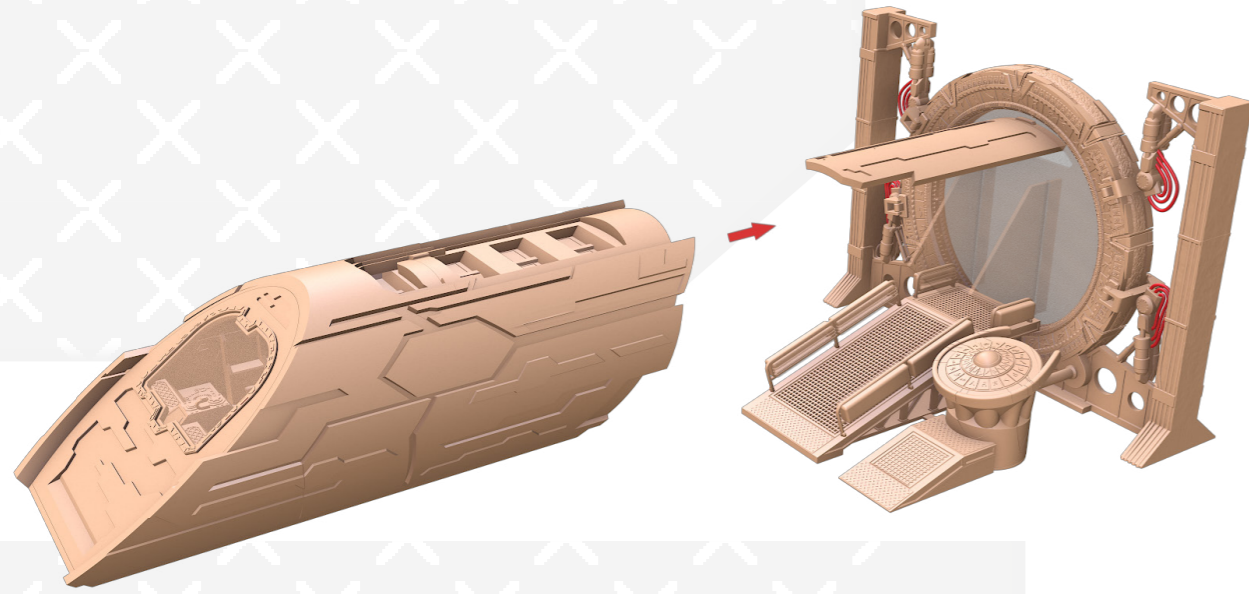

44

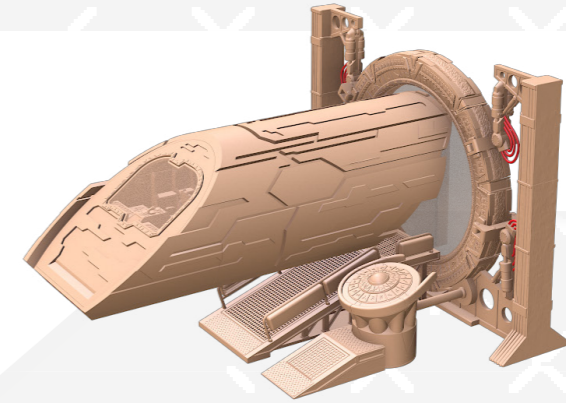
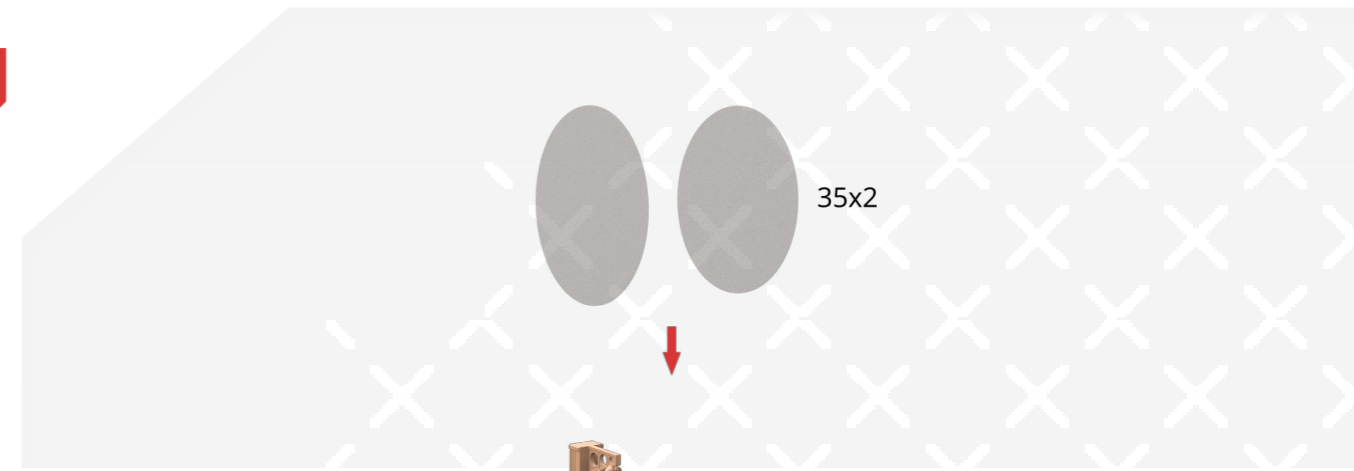

STL files of all 3D printing models come with full technical support from Gamboddy team for life. If you have any questions or if you want to have any changes introduced, please, write to us at [support@gamboddy.com](mailto:support@gamboddy.com).

Thank you for choosing  
Gamboddy!

